

Assortment Pick Sheets

SEARCH - You can search by either the CD# or description.

























Example 1: If you need to search for CD-197, simply type 197. Do not include the CD prefix.

or











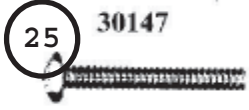

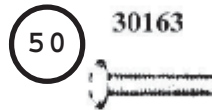



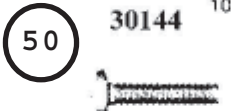
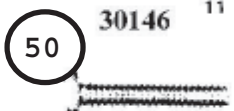

Example 2: If you know the description of a CD, type in a vague description like machine screws.

PRINT- When printing a particular page, be sure to select the “current” page and the correct page orientation (i.e. landscape or portrait).

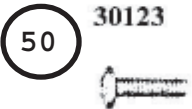





















CD - 102 Machine Screws & Nuts
99902 24 Space Tray

CHOICE DISTRIBUTION		CD-102 Machine Screws & Nuts				111 BELL STREET W. BABYLON, NY 11704 (631) 756-0120	
<p>33009 ¹</p>  <p>6-32 UNC (USS) Hex Nut</p> <p>50</p>	<p>33011 ²</p>  <p>8-32 UNC (USS) Hex Nut</p> <p>50</p>	<p>33012 ³</p>  <p>10-24 UNC (USS) Hex Nut</p> <p>50</p>	<p>33014 ⁴</p>  <p>10-32 UNF (SAE) Hex Nut</p> <p>50</p>	<p>33016 ⁵</p>  <p>12-24 UNC (USS) Hex Nut</p> <p>50</p>	<p>33018 ⁶</p>  <p>1/4-20 UNC (USS) Hex Nut</p> <p>50</p>		
<p>33105 ⁷</p>  <p>6-32 x 1/2" UNC (USS)</p> <p>50</p>	<p>33107 ⁸</p>  <p>6-32 x 3/4" UNC (USS)</p> <p>50</p>	<p>33123 ⁹</p>  <p>8-32 x 1/2" UNC (USS)</p> <p>50</p>	<p>33125 ¹⁰</p>  <p>8-32 x 3/4" UNC (USS)</p> <p>50</p>	<p>33127 ¹¹</p>  <p>8-32 x 1" UNC (USS)</p> <p>50</p>	<p>33148 ¹²</p>  <p>10-24 x 1-1/2" UNC (USS)</p> <p>25</p>		
<p>33161 ¹³</p>  <p>10-32 x 1/2" UNF (SAE)</p> <p>50</p>	<p>33163 ¹⁴</p>  <p>10-32 x 3/4" UNF (SAE)</p> <p>50</p>	<p>33165 ¹⁵</p>  <p>10-32 x 1" UNF (SAE)</p> <p>50</p>	<p>33142 ¹⁶</p>  <p>10-24 x 1/2" UNC (USS)</p> <p>50</p>	<p>33144 ¹⁷</p>  <p>10-24 x 3/4" UNC (USS)</p> <p>50</p>	<p>33146 ¹⁸</p>  <p>10-24 x 1" UNC (USS)</p> <p>25</p>		
<p>33180 ¹⁹</p>  <p>12-24 x 1/2" UNC (USS)</p> <p>25</p>	<p>33182 ²⁰</p>  <p>12-24 x 3/4" UNC (USS)</p> <p>25</p>	<p>33191 ²¹</p>  <p>1/4-20 x 1/2" UNC (USS)</p> <p>25</p>	<p>33193 ²²</p>  <p>1/4-20 x 3/4" UNC (USS)</p> <p>25</p>	<p>33195 ²³</p>  <p>1/4-20 x 1" UNC (USS)</p> <p>25</p>	<p>33197 ²⁴</p>  <p>1/4-20 x 1-1/2" UNC (USS)</p> <p>25</p>		























CD - 103 Phillips Pan Head Machine Screws
99902 24 Space Tray



















CHOICE DISTRIBUTION		CD-103 Phillips Pan Head Machine Screws				111 BELL STREET W. BABYLON, NY 11704 (516) 756-0120	
<p>25 30147¹</p>  <p>10-24 x 1 1/4" UNC (USS)</p>		<p>50 30161³</p>  <p>10-32 x 1/2" UNF (SAE)</p>	<p>50 30163⁴</p>  <p>10-32 x 3/4" UNF (SAE)</p>	<p>50 30165⁵</p>  <p>10-32 x 1" UNF (SAE)</p>	<p>25 30195⁶</p>  <p>1/4"-20 x 1" UNC (USS)</p>		
<p>50 30125⁷</p>  <p>8-32 x 3/4" UNC (USS)</p>	<p>50 30127⁸</p>  <p>8-32 x 1" UNC (USS)</p>	<p>50 30142⁹</p>  <p>10-24 x 1/2" UNC (USS)</p>	<p>50 30144¹⁰</p>  <p>10-24 x 3/4" UNC (USS)</p>	<p>50 30146¹¹</p>  <p>10-24 x 1" UNC (USS)</p>	<p>25 30193¹²</p>  <p>1/4"-20 x 3/4" UNC (USS)</p>		
<p>50 30101¹³</p>  <p>6-32 x 1/4" UNC (USS)</p>	<p>50 30105¹⁴</p>  <p>6-32 x 1/2" UNC (USS)</p>	<p>50 30107¹⁵</p>  <p>6-32 x 3/4" UNC (USS)</p>		<p>50 30123¹⁷</p>  <p>8-32 x 1/2" UNC (USS)</p>			
<p>50 33009¹⁹</p>  <p>6-32 UNC (USS) HEX NUT</p>	<p>50 33011²⁰</p>  <p>8-32 UNC (USS) HEX NUT</p>	<p>50 33012²¹</p>  <p>10-24 UNC (USS) HEX NUT</p>	<p>50 33014²²</p>  <p>10-32 UNF (SAE) HEX NUT</p>	<p>50 33018²³</p>  <p>1/4"-20 UNC (USS) HEX NUT</p>			

CD - 104 Machine Screws
99902 24 Space Tray

CHOICE DISTRIBUTION		CD 104 machine screws				111 BELL STREET W. BABYLON, NY 11704 (516) 756-0120
1	2	<p>50 33101 3</p>  <p>6 - 32 x 1/4" USS</p>	<p>50 33105 4</p>  <p>6 - 32 x 1/2" USS</p>	<p>50 33106 5</p>  <p>6 - 32 x 5/8" USS</p>	<p>50 33144 6</p>  <p>10 - 24 x 3/4" USS</p>	
<p>50 33120 7</p>  <p>8 - 32 x 1/4" USS</p>	<p>50 33122 8</p>  <p>8 - 32 x 3/8" USS</p>	<p>50 33123 9</p>  <p>8 - 32 x 1/2" USS</p>	<p>50 33125 10</p>  <p>8 - 32 x 3/4" USS</p>	<p>25 33127 11</p>  <p>8 - 32 x 1" USS</p>	<p>25 33146 12</p>  <p>10 - 24 x 1" USS</p>	
<p>50 33160 13</p>  <p>10 - 32 x 1/4" SAE</p>	<p>50 33161 14</p>  <p>10 - 32 x 1/2" SAE</p>	<p>50 33163 15</p>  <p>10 - 32 x 3/4" SAE</p>	<p>25 33165 16</p>  <p>10 - 32 x 1" SAE</p>	<p>25 33167 17</p>  <p>10 - 32 x 1-1/2" SAE</p>	<p>25 33148 18</p>  <p>10 - 24 x 1-1/2" USS</p>	
<p>50 33180 19</p>  <p>12 - 24 x 1/2" USS</p>	<p>50 33182 20</p>  <p>12 - 24 x 3/4" USS</p>	<p>25 33183 21</p>  <p>12 - 24 x 1" USS</p>	<p>25 33185 22</p>  <p>12 - 24 x 1-1/2" USS</p>	<p>25 33193 23</p>  <p>1/4 - 20 x 3/4" USS</p>	<p>25 33191 24</p>  <p>1/4 - 20 x 1/2" USS</p>	

CD - 105 Phillips Pan Head Machine Screws
99902 24 Space Tray























CHOICE DISTRIBUTION		CD-105 Phillips Pan Head Machine Screws				111 BELL STREET W. BABYLON, NY 11704 (516) 756-0120	
1	2	3 50 30101  6 - 32 x 1/4" USS	4 50 30105  6 - 32 x 1/2" USS	5 50 30106  6 - 32 x 5/8" USS	6 50 30144  10 - 24 x 3/4" USS		
7 50 30120  8 - 32 x 1/4" USS	8 50 30122  8 - 32 x 3/8" USS	9 50 30123  8 - 32 x 1/2" USS	10 50 30125  8 - 32 x 3/4" USS	11 25 30127  8 - 32 x 1" USS	12 25 30146  10 - 24 x 1" USS		
13 50 30160  10 - 32 x 1/4" SAE	14 50 30161  10 - 32 x 1/2" SAE	15 50 30163  10 - 32 x 3/4" SAE	16 25 30165  10 - 32 x 1" SAE	17 25 30167  10 - 32 x 1-1/2" SAE	18 25 30148  10 - 24 x 1-1/2" USS		
19 50 30180  12 - 24 x 1/2" USS	20 50 30182  12 - 24 x 3/4" USS	21 25 30183  12 - 24 x 1" USS	22 25 30185  12 - 24 x 1-1/2" USS	23 25 30193  1/4 - 20 x 3/4" USS	24 25 30191  1/4 - 20 x 1/2" USS		

CHOICE DISTRIBUTION		CD-106 Small Nuts				111 BELL STREET W. BABYLON, NY 11704 (631) 756-0120	
<p>33006 ¹</p>  <p>50</p> <p>HEX NUT 4-40 UNC (USS)</p>	<p>33009 ²</p>  <p>50</p> <p>HEX NUT 6-32 UNC (USS)</p>	<p>33011 ³</p>  <p>50</p> <p>HEX NUT 8-32 UNC (USS)</p>	<p>33012 ⁴</p>  <p>50</p> <p>HEX NUT 10-24 UNC (USS)</p>	<p>33016 ⁵</p>  <p>50</p> <p>HEX NUT 12-24 UNC (USS)</p>	<p>33028 ⁶</p>  <p>25</p> <p>WING NUT 10-32 UNF (SAE)</p>		
<p>7</p>	<p>33044 ⁸</p>  <p>50</p> <p>HEX "KEPS" NUT (w/Att. S/Proof Washer) 6-32 UNC (USS)</p>	<p>33045 ⁹</p>  <p>50</p> <p>HEX "KEPS" NUT (w/Att. S/Proof Washer) 8-32 UNC (USS)</p>	<p>33046 ¹⁰</p>  <p>50</p> <p>HEX "KEPS" NUT (w/Att. S/Proof Washer) 10-24 UNC (USS)</p>	<p>33047 ¹¹</p>  <p>50</p> <p>HEX "KEPS" NUT (w/Att. S/Proof Washer) 10-32 UNF (SAE)</p>	<p>33029 ¹²</p>  <p>25</p> <p>WING NUT 1/4-20 UNC (USS)</p>		
<p>33018 ¹³</p>  <p>50</p> <p>HEX NUT 1/4-20 UNC (USS)</p>	<p>33049 ¹⁴</p>  <p>25</p> <p>HEX "KEPS" NUT (w/Att. S/Proof Washer) 1/4-20 UNC</p>	<p>15</p>	<p>16</p>	<p>33014 ¹⁷</p>  <p>50</p> <p>HEX NUT 10-32 (3/16) UNF (SAE)</p>	<p>33030 ¹⁸</p>  <p>25</p> <p>WING NUT 5/16-18 UNC (USS) List</p>		
<p>33048 ¹⁹</p>  <p>50</p> <p>HEX "KEPS" NUT 12-28 UNC (USS)</p>	<p>33050 ²⁰</p>  <p>25</p> <p>HEX "KEPS" NUT 1/4-28 UNF (SAE)</p>	<p>21</p>	<p>22</p>	<p>23</p>	<p>33031 ²⁴</p>  <p>25</p> <p>WING NUT 3/8-16 UNC (USS) List</p>		





























CD - 107 Slotted Flat Head Machine Screws

99902 24 Space Tray























CHOICE
CHOICE
DISTRIBUTION INC.
www.choice-distribution.com

CHOICE DISTRIBUTION		CD-107 Slotted Flat Head Machine Screws				111 BELL STREET W. BABYLON, NY 11704 (631) 756-0120	
<p>33305 ¹</p> <p>50</p>  <p>6 - 32 x 1/2" USS</p>	<p>33323 ²</p> <p>50</p>  <p>8 - 32 x 1/2" USS</p>	<p>33328 ³</p> <p>50</p>  <p>8 - 32 x 1-1/4" USS</p>	<p>33363 ⁴</p> <p>50</p>  <p>10 - 32 x 3/4" SAE</p>	<p>33380 ⁵</p> <p>50</p>  <p>12 - 24 x 5/8" USS</p>	<p>33391 ⁶</p> <p>25</p>  <p>1/4 - 20 x 1/2" USS</p>		
<p>33306 ⁷</p> <p>50</p>  <p>6 - 32 x 5/8" USS</p>	<p>33324 ⁸</p> <p>50</p>  <p>8 - 32 x 5/8" USS</p>	<p>9 ⁹</p>	<p>33365 ¹⁰</p> <p>50</p>  <p>10 - 32 x 1" SAE</p>	<p>33382 ¹¹</p> <p>50</p>  <p>12 - 24 x 3/4" USS</p>	<p>33393 ¹²</p> <p>25</p>  <p>1/4 - 20 3/4" USS</p>		
<p>33307 ¹³</p> <p>50</p>  <p>6 - 32 x 3/4" USS</p>	<p>33325 ¹⁴</p> <p>50</p>  <p>8 - 32 x 3/4" USS</p>	<p>33361 ¹⁵</p> <p>50</p>  <p>10 - 32 x 1/2" SAE</p>	<p>33367 ¹⁶</p> <p>25</p>  <p>10 - 32 x 1-1/2" SAE</p>	<p>33383 ¹⁷</p> <p>25</p>  <p>12 - 24 x 1" USS</p>	<p>33395 ¹⁸</p> <p>25</p>  <p>1/4 - 20 x 1" USS</p>		
<p>33309 ¹⁹</p> <p>50</p>  <p>6 - 32 x 1" USS</p>	<p>33327 ²⁰</p> <p>50</p>  <p>8 - 32 x 1" USS</p>	<p>33362 ²¹</p> <p>50</p>  <p>10 - 32 x 5/8" SAE</p>	<p>33346 ²²</p>  <p>10 - 24 x 1" USS</p>	<p>33384 ²³</p> <p>25</p>  <p>12 - 24 x 1-1/4" USS</p>	<p>33397 ²⁴</p> <p>25</p>  <p>1/4 - 20 x 1-1/2" USS</p>		

CD - 108 Small Washers
99903 16 Space Tray

CHOICE DISTRIBUTION		CD-108 Small Washers		111 BELL STREET W. BABYLON, NY 11704 (516) 756-0120			
 31747  #4 LOCK WASHER	1	 31748  #6 LOCK WASHER	2	 31749  #8 LOCK WASHER	3	 31750  #10 LOCK WASHER	4
 31750-1  #12 LOCK WASHER	5	 37767  #4 HIGH COLLAR LOCK WASHER	6	 37768  #6 HIGH COLLAR LOCK WASHER	7	 37769  #8 HIGH COLLAR LOCK WASHER	8
 37770  #10 HIGH COLLAR LOCK WASHER	9	 31696  #4 SAE FLAT WASHER	10	 31697  #6 SAE FLAT WASHER	11	 31698  #8 SAE FLAT WASHER	12
 31699  #10 SAE FLAT WASHER	13	 31700  #12 SAE FLAT WASHER	14		15		16

CD - 109 Small Socket Head Cap Screws
 99902 24 Space Tray
 10 each

CHOICE DISTRIBUTION		CD-109 Small Socket Head Cap Screws				111 BELL STREET W. BABYLON, NY 11704 (516) 756-0120
28950 ¹  6-32 x 1/4	28951 ²  6-32 x 3/8	28952 ³  6-32 x 1/2	28953 ⁴  6-32 x 5/8	28954 ⁵  6-32 x 3/4	28974 ⁶  10-24 x 1-1/2	
28955 ⁷  6-32 x 1	28961 ⁸  8-32 x 3/8	28962 ⁹  8-32 x 1/2	28963 ¹⁰  8-32 x 5/8	28965 ¹¹  8-32 x 3/4	28976 ¹²  10-24 x 2	
28966 ¹³  8-32 x 1	28968 ¹⁴  8-32 x 1-1/2	28970 ¹⁵  10-24 x 1/2	28971 ¹⁶  10-24 x 3/4	28972 ¹⁷  10-24 x 1	29274 ¹⁸  10-32 x 1-1/2	
29270 ¹⁹  10-32 x 1/2	29271 ²⁰  10-32 x 3/4	29272 ²¹  10-32 x 1	29273 ²²  10-32 x 1-1/4	23	29276 ²⁴  10-32 x 2	

CD - 110 Self Tapping Machine Screws 99905 Adjustable Space Tray

CHOICE CHOICE

DISTRIBUTION INC.
www.choice-distribution.com

CHOICE
DISTRIBUTION

CD-110 self tapping machine screws

111 BELL STREET
W. BABYLON, NY 11704
(516) 756-0120



10-24 X 3/8"



10-24 X 1/2"



10-24 X 3/4"



10-24 X 1"

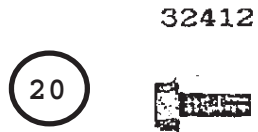

12-24 X 1/2"



1/4-20 X 1/2"



1/4-20 x 3/4"

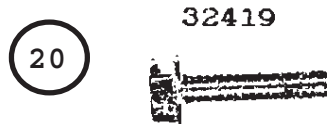

1/4-20 X 1"

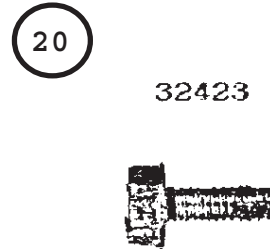

5/16-18 x 3/4"

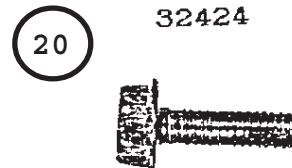

5/16-18 x 1"

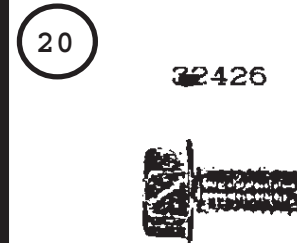



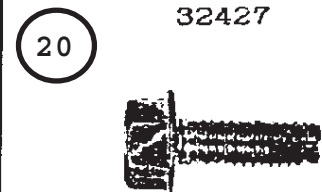





















3/8-16 X 3/4"



3/8-16 x 1"

CD - 111 Phillips Flat Head Machine Screws

99902 24 Space Tray

CHOICE DISTRIBUTION		CD-111 Phillips Flat Head Machine Screws				111 BELL STREET W. BABYLON, NY 11704 (516) 756-0120					
50	49094 ¹  4-40-1/4	50	49095 ²  4-40-1/2	50	49098 ³  4-40-3/4	50	49105 ⁴  6-32-1/2	50	49107 ⁵  6-32-3/4	10	49147 ⁶  10-24-1-1/4
50	49109 ⁷  6-32-1	50	49120 ⁸  8-32-1/4	50	49123 ⁹  8-32-1/2	50	49125 ¹⁰  8-32-3/4	50	49127 ¹¹  8-32-1	10	49148 ¹²  10-24-1-1/2
50	49142 ¹³  10-24-1/2	50	49144 ¹⁴  10-24-3/4	50	49146 ¹⁵  10-24-1	50	49161 ¹⁶  10-32-1/2	50	49163 ¹⁷  10-32-3/4	10	49196 ¹⁸  1/4-20-1-1/4
25	49165 ¹⁹  10-32-1	25	49166 ²⁰  10-32-1-1/4	25	49191 ²¹  1/4-20-1/2	25	49193 ²²  1/4-20-3/4	25	49195 ²³  1/4-20-1	10	49197 ²⁴  1/4-20-1-1/2

CD - 112 Sheet Metal Screws
 99937 20 Space Tray
 99936 Outside Shell

CHOICE
CHOICE
 DISTRIBUTION INC.
www.choice-distribution.com



















CHOICE DISTRIBUTION		CD - 112 Sheet Metal Screws Hex Washer Head Slotted Indented		111 BELL STREET W. BABYLON, NY 11704 (516) 756-0120											
50	32222	1	No. 8 x 1/2"	50	32260	2	No. 12 x 1/2"	50	32282	3	1/4" x 3/4"	25	32290	4	5/16" x 3/4"
50	32241	5	No. 10 x 1/2"	50	32262	6	No. 12 x 3/4"	50	32284	7	1/4" x 1"	25	32291	8	5/16" x 1"
50	32243	9	No. 10 x 3/4"	50	32264	10	No. 12 x 1"	25	32285	11	1/4" x 1-1/4"	25	32292	12	5/16" x 1-1/4"
50	32245	13	No. 10 x 1"	50	32280	14	1/4" x 1/2"	25	32289	15	5/16" x 1/2"	25	32292	16	5/16" x 1 1/4"
		17				18				19				20	

CD - 115 Sheet Metal Screws
 99937 20 Space Tray
 99936 Outside Shell

















CHOICE
CHOICE
 DISTRIBUTION INC.
www.choice-distribution.com

CHOICE DISTRIBUTION		CD-115 Sheet metal screws		111 BELL STREET W. BABYLON, NY 11704 (516) 756-0120	
25	32223 No. 8 x 5/8	1	25	32241 No. 10 x 1/2	2
25	32282 1/4 x 3/4	3	10	32291 5/16 x 1	4
25	32221 No. 8 x 3/8	5			6
25	32280 1/4 x 1/2	7	10	32290 5/16 x 3/4	8
25	32214 No. 6 x 3/4	9	25	32228 No. 8 x 1 1/2	10
25	32266 No. 12 x 1 1/2	11	10	32288 1/4 x 2	12
25	32212 No. 6 x 1/2	13	25	32226 No. 8 x 1	14
25	32247 No. 10 x 1 1/2	15	10	32286 1/4 x 1 1/2	16
25	32211 No. 6 x 3/8	17	25	32224 No. 8 x 3/4	18
25	32242 No. 10 x 5/8	19	10	32284 1/4 x 1	20











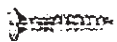

CD - 116 Sheet Metal Screws
99902 24 Space Tray

CHOICE DISTRIBUTION		CD 116		Sheet metal screws		111 BELL STREET W. BABYLON, NY 11704 (516) 756-0120	
32710  6 x 1/4" (50)	32711  6 x 3/8" (50)	32712  6 x 1/2" (50)	32714  6 x 3/4" (50)		32745  10 x 1" (50)		
		32721  8 x 3/8" (50)	32722  8 x 1/2" (50)	32724  8 x 3/4" (50)	32764  12 x 1" (25)		
32726  8 x 1" (50)	32727  8 x 1-1/4" (50)	32741  10 x 1/2" (50)		32743  10 x 3/4" (50)	32783  14 x 7/8" (25)		
32760  12 x 1/2" (25)		32762  12 x 3/4" (25)	32780  14 x 1/2" (25)	32782  14 x 3/4" (25)	32784  14 x 1" (25)		

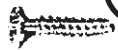
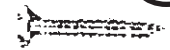
CD - 117 Phillips Flat Sheet Metal Screws
99902 24 Space Tray

CHOICE DISTRIBUTION		CD-117 Phillips Flat Sheet Metal Screws				111 BELL STREET W. BABYLON, NY 11704 (631) 756-0120	
1	2	3 50 32612  #6 x 1/2"	4 50 32614  #6 x 3/4"	5 25 32616  #6 x 1"	6 25 32618  #6 x 1-1/2"		
7 25 32622  #8 x 1/2"	8 25 32624  #8 x 3/4"	9 25 32626  #8 x 1"	10 25 32627  #8 x 1-1/4"	11 25 32628  #8 x 1-1/2"	12 25 32629  #8 x 1-3/4"		
13	14 25 32645  #10 x 1"	15 25 32646  #10 x 1-1/4"	16 25 32647  #10 x 1-1/2"	17	18		
19	20 25 32664  #12 x 1"	21 25 32665  #12 x 1-1/4"	22 25 32666  #12 x 1-1/2"	23	24 25 32686  #14 x 1-1/2"		



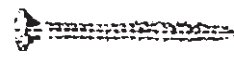
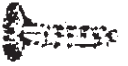
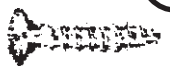
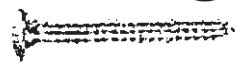
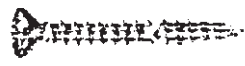















CD - 118 Oval Head Sheet Metal Screws
99902 24 Space Tray











CHOICE DISTRIBUTION		CD-118 sheet metal screws oval head				111 BELL STREET W. BABYLON, NY 11704 (516) 756-0120				
32912  6 x 1/2"	1 25	32913  6 x 5/8"	2 25	32914  6 x 3/4"	3 25	32916  6 x 1"	5 25	32917  6 x 1-1/4"	6 25	
32921  8 x 3/8"	7 25	32923  8 x 5/8"	8 25	32924  8 x 3/4"	9 25	32926  8 x 1"	11 25	32927  8 x 1-1/4"	12 25	
32941  10 x 1/2"	13 25	32942  10 x 5/8"	14 25	32943  10 x 3/4"	15 25	32945  10 x 1"	16 25	32928  8 x 1-1/2"	17 25	18
32962  12 x 3/4"	19 25	32964  12 x 1"	20 25		21	32947  10 x 1-1/2"	22 25	32949  10 x 2"	23 25	24

CD - 120 Phillips Head Sheet Metal Screws

99902 24 Space Tray

















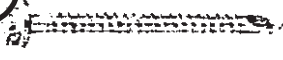

CHOICE
CHOICE
DISTRIBUTION INC.
www.choice-distribution.com

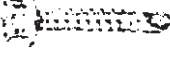
CHOICE DISTRIBUTION		CD-120 SHEETMETAL SCREWS PHILLIPS HEAD				111 BELL STREET W. BABYLON, NY 11704 (516) 756-0120	
32810 1  6 x 1/4" 50	32811 2  6 x 3/8" 50	32812 3  6 x 1/2" 50	32814 4  6 x 3/4" 50				
	32821 8  8 x 3/8" 50	32822 9  8 x 1/2" 50	32824 10  8 x 3/4" 50	32826 11  8 x 1" 50	32827 12  8 x 1-1/4" 25		
32841 13  10 x 1/2" 50		32843 15  10 x 3/4" 50	32845 16  10 x 1" 50	32860 17  12 x 1/2" 50	32864 18  12 x 1" 25		
	32862 20  12 x 3/4" 25	32880 21  14 x 1/2" 25	32882 22  14 x 3/4" 25	32884 23  1/4 x 1" 25	32885 24  1/4 x 1 1/4" 25		





CHOICE DISTRIBUTION	CD-121 POWER BITS			111 BELL STREET W. BABYLON, NY 11704 (516) 756-0120
<p data-bbox="254 451 327 526">3</p> <p data-bbox="352 435 426 467">2651</p>  <p data-bbox="268 652 506 766">#1 PHILLIPS INSERT BITS</p>	<p data-bbox="632 451 705 526">3</p> <p data-bbox="793 441 867 474">2661</p>  <p data-bbox="718 646 955 760">#1 PHILLIPS POWER BITS</p>	<p data-bbox="1136 451 1209 526">2</p> <p data-bbox="1255 441 1329 474">2665</p>  <p data-bbox="1180 652 1417 766">#2 DOUBLE END INSERT BITS</p>	<p data-bbox="1556 451 1629 526">2</p> <p data-bbox="1705 441 1799 474">32397</p>  <p data-bbox="1621 691 1858 766">1/4 in. NUT DRIVER</p>	
<p data-bbox="254 824 327 899">3</p> <p data-bbox="352 824 426 857">2652</p>  <p data-bbox="277 993 514 1107">#2 PHILLIPS INSERT BITS</p>	<p data-bbox="632 824 705 899">3</p> <p data-bbox="793 815 867 847">2662</p>  <p data-bbox="718 987 955 1101">#2 PHILLIPS POWER BITS</p>	<p data-bbox="1136 824 1209 899">1</p> <p data-bbox="1255 824 1329 857">2667</p>  <p data-bbox="1159 1036 1396 1107">MAGNETIC BIT HOLDER</p>	<p data-bbox="1556 824 1629 899">2</p> <p data-bbox="1705 824 1799 857">32398</p>  <p data-bbox="1621 1032 1858 1107">5/16 in. NUT DRIVER</p>	
<p data-bbox="254 1166 327 1240">3</p> <p data-bbox="352 1172 426 1205">2653</p>  <p data-bbox="256 1302 493 1416">#3 PHILLIPS INSERT BITS</p>	<p data-bbox="632 1166 705 1240">3</p> <p data-bbox="793 1156 867 1188">2663</p>  <p data-bbox="718 1295 955 1409">#3 PHILLIPS POWER BITS</p>		<p data-bbox="1556 1166 1629 1240">2</p> <p data-bbox="1684 1172 1778 1205">32399</p>  <p data-bbox="1629 1341 1866 1416">3/8 in. NUT DRIVER</p>	

CD - 122 Tek's 3 Sheet Metal Screws
 99937 20 Space Tray
 99936 Outside Shell















CHOICE
CHOICE
 DISTRIBUTION INC.
www.choice-distribution.com

CHOICE DISTRIBUTION		CD-122 "TEKS 3" Sheet metal screws				111 BELL STREET W. BABYLON, NY 11704 (516) 756-0120					
25	32384	1	25	32322	2	25	32324	3	25	32326	4
											
	1/4-14 x 1"			8-18 x 1/2"			8-18 x 3/4"			8-18 x 1"	
25	32365	5	25	32366	6	25	32368	7	25	32382	8
											
	12-14 x 1-1/4"			12-14 x 1-1/2"			12-14 x 2"			1/4-14 x 3/4"	
25	32347	9	25	32349	10	25	32362	11	25	32364	12
											
	10-16 x 1-1/2"			10-16 x 2"			12-14 x 3/4"			12-14 x 1"	
25	32342	13	25	32343	14	25	32345	15	25	32346	16
											
	10-16 x 1/2"			10-16 x 3/4"			10-16 x 1"			10-16 x 1-1/4"	
		17	1	32397	18	1	32398	19	1	32399	20
											
				1/4" DRIVE CHUCK			5/16" DRIVE CHUCK			3/8" DRIVE CHUCK	

CD - 123 Phillips Head TekS Screws
99905 Adjustable Space Tray

















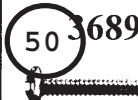

CHOICE DISTRIBUTION		CD-123 PHILLIP TekS SCREWS		111 BELL STREET W. BABYLON, NY 11704 (516) 756-0120	
Quantity	Part Number	Illustration Not Actual Size	Part Number	Quantity	Part Number
50	32511		32522	25	32541
	6 x 3/8		8 x 1/2		10 x 1/2
50	32512		32524	25	32542
	6 x 1/2		8 x 3/4		10 x 5/8
50	32514		32526	25	32543
	6 x 3/4		8 x 1		10 x 3/4
50	32516		32528	25	32545
	6 x 1		8 x 1 1/2		10 x 1
1	2661		2662	1	32546
	#1 PHILLIPS POWER TIP		#2 PHILLIPS POWER TIP		10 x 1 1/4
	Illustration Not Actual Size				1
					2663
					#3 PHILLIPS POWER TIP

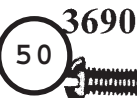
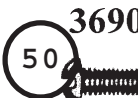
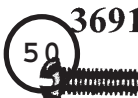
CD - 124 Stainless Steel Phillips TekS Screws
 99905 Adjustable Space Tray







CHOICE DISTRIBUTION		CD-124 Stainless Steel Phillip TekS		111 BELLE STREET W. BABYLON, NY 11704 (631) 766-0120	
50	75250  6 x 3/8	50	75254  8 x 1/2	25	75258  10 x 1/2
50	75251  6 x 1/2	50	75255  8 x 3/4	25	75259  10 x 5/8
50	75252  6 x 3/4	50	75256  8 x 1		75261  10 x 1
50	75253  6 x 1	50	75257  8 x 1 1/2	25	75260  10 x 3/4
		1	2661  #1 PHILLIPS POWER TIP	1	2662  #2 PHILLIPS POWER TIP
				1	2663  #3 PHILLIPS POWER TIP

CD - 125 Brass Machine Screws & Nuts

99902 24 Space Tray













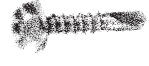

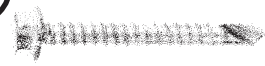
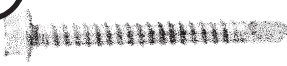

CHOICE DISTRIBUTION		CD-125 Brass Machine Screws & Nuts				111 BELL STREET W. BABYLON, NY 11704 (631) 756-0120	
<p>36871 ¹</p>  <p>6-32 UNC (USS) Hex Nut</p>	<p>36872 ²</p>  <p>8-32 UNC (USS) Hex Nut</p>	<p>36873 ³</p>  <p>10-24 UNC (USS) Hex Nut</p>	<p>36874 ⁴</p>  <p>10-32 UNF (SAE) Hex Nut</p>		<p>36875 ⁶</p>  <p>1/4-20 UNC (USS) Hex Nut</p>		
<p>36892 ⁷</p>  <p>6-32 x 1/2" UNC (USS)</p>	<p>36894 ⁸</p>  <p>6-32 x 3/4" UNC (USS)</p>	<p>36897 ⁹</p>  <p>8-32 x 1/2" UNC (USS)</p>	<p>36898 ¹⁰</p>  <p>8-32 x 3/4" UNC (USS)</p>	<p>36899 ¹¹</p>  <p>8-32 x 1" UNC (USS)</p>	<p>36906 ¹²</p>  <p>10-24 x 1-1/2" UNC (USS)</p>		
<p>36908 ¹³</p>  <p>10-32 x 1/2" UNF (SAE)</p>	<p>36909 ¹⁴</p>  <p>10-32 x 3/4" UNF (SAE)</p>	<p>36910 ¹⁵</p>  <p>10-32 x 1" UNF (SAE)</p>	<p>36902 ¹⁶</p>  <p>10-24 x 1/2" UNC (USS)</p>	<p>36903 ¹⁷</p>  <p>10-24 x 3/4" UNC (USS)</p>	<p>36904 ¹⁸</p>  <p>10-24 x 1" UNC (USS)</p>		
		<p>36913 ²¹</p>  <p>1/4-20 x 1/2" UNC (USS)</p>	<p>36914 ²²</p>  <p>1/4-20 x 3/4" UNC (USS)</p>	<p>36915 ²³</p>  <p>1/4-20 x 1" UNC (USS)</p>	<p>36917 ²⁴</p>  <p>1/4-20 x 1-1/2" UNC (USS)</p>		

CD - 126 Drywall Screws
99905 Adjustable Space Tray

CHOICE DISTRIBUTION		CD-126 Drywall Screws		111 BELL STREET 72, BABYLON, NY 11704 (831) 756-0120	
15035  #6 x 1" 50	15037  #6 x 1-5/8" 50	15040  #6 x 2-1/4" 50	15047  #8 x 3" 25		
15036  #6 x 1-1/4" 50	15039  #6 x 2" 50	15046  #8 x 2-1/2" 50			















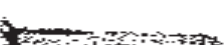

CD - 127 Stainless Steel Hex Head Tek
 99937 20 Space Tray
 99936 Outside Shell

CHOICE
CHOICE
 DISTRIBUTION INC.
www.choice-distribution.com

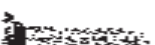

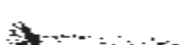

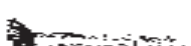
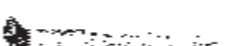











CHOICE DISTRIBUTION		CD-127 Stainless Steel Hex Head TEKS				111 BELL STREET W. BABYLON, NY 11704 (631) 756-0120					
25	74221	1	25	74204	2	25	74206	3	25	74207	4
											
	1/4-14 x 1"			8-18 x 1/2"			8-18 x 3/4"			8-18 x 1"	
25	74208	5	25	74218	6	25	74219	7	25	74220	8
											
	8-18 x 1-1/4"			12-14 x 1-1/2"			12-14 x 2"			1/4-14 x 3/4"	
25	74215	9	25	74224	10	25	74216	11	25	74217	12
											
	10-16 x 1-1/2"			1/4-14 x 2"			12-14 x 3/4"			12-14 x 1"	
25	74210	13	25	74212	14	25	74213	15	25	74214	16
											
	10-16 x 1/2"			10-16 x 3/4"			10-16 x 1"			10-16 x 1-1/4"	
		17	1	32397	18	1	32398	19	1	32399	20
											
				1/4" DRIVE CHUCK			5/16" DRIVE CHUCK			3/8" DRIVE CHUCK	

CD - 128 Stainless Steel Phillips Oval Head Machine Screws
 99937 20 Space Tray
 99936 Outside Shell

CHOICE DISTRIBUTION		CD-128 Stainless Steel Phillips Oval Head Machine Screws		111 BELL STREET W. BABYLON, NY 11704 (631) 756-0120	
25	75110 6/32x1/4	25	75112 6/32x1/2	25	75114 6/32x3/4
25	75116 6/32x1	25	75120 8/32x1/4	25	75123 8/32x1/2
25	75125 8/32x3/4	25	75127 8/32x1	25	75140 10/24x3/8
25	75142 10/24x1/2	25	75144 10/24x3/4	25	75146 10/24x1
25	75160 10/32x3/8	25	75161 10/32x1/2	25	75163 10/32x3/4
25	75165 10/32x1	10	75193 1/4-20x3/4	10	75195 1/4-20x1
10	75196 1/4-20x1 1/4	10	75197 1/4-20x1 1/2		

















CHOICE DISTRIBUTION	CD-130 Slotted Flat Head Wood Screws					111 BELLE STREET W. SAFFORD, NY 11734 (607) 756-0120
	<p>34023 ²</p>  <p>#4 x 3/4" (50)</p>	<p>34041 ³</p>  <p>#6 x 1/2" (50)</p>	<p>34043 ⁴</p>  <p>#6 x 3/4" (50)</p>	<p>34045 ⁵</p>  <p>#6 x 1" (25)</p>	<p>34047 ⁶</p>  <p>#6 x 1-1/2" (25)</p>	
<p>34070 ⁷</p>  <p>#8 x 1/2" (25)</p>	<p>34072 ⁸</p>  <p>#8 x 3/4" (25)</p>	<p>34074 ⁹</p>  <p>#8 x 1" (25)</p>	<p>34075 ¹⁰</p>  <p>#8 x 1-1/4" (25)</p>	<p>34076 ¹¹</p>  <p>#8 x 1-1/2" (25)</p>	<p>34077 ¹²</p>  <p>#8 x 1-3/4" (25)</p>	
<p>34092 ¹³</p>  <p>#10 x 3/4" (25)</p>	<p>34094 ¹⁴</p>  <p>#10 x 1" (25)</p>	<p>34095 ¹⁵</p>  <p>#10 x 1-1/4" (25)</p>	<p>34096 ¹⁶</p>  <p>#10 x 1-1/2" (25)</p>		<p>34121 ¹⁸</p>  <p>#14 x 1-1/4" (25)</p>	
	<p>34110 ²⁰</p>  <p>#12 x 1" (25)</p>	<p>34111 ²¹</p>  <p>#12 x 1-1/4" (25)</p>	<p>34112 ²²</p>  <p>#12 x 1-1/2" (25)</p>	<p>34120 ²³</p>  <p>#14 x 1" (25)</p>	<p>34122 ²⁴</p>  <p>#14 x 1-1/2" (25)</p>	

CD - 131 Phillips Flat Head Wood Screws
99902 24 Space Tray

CHOICE DISTRIBUTION		CD-131 Phillips Flat Head Wood Screws				111 BELL STREET W. BABYLON, NY 11704 (631) 756-0120	
1	2	50 34441  #6 x 1/2"	50 34443  #6 x 3/4"	25 34445  #6 x 1"	25 34447  #6 x 1-1/2"		
25 34470  #8 x 1/2"	25 34472  #8 x 3/4"	25 34474  #8 x 1"	25 34475  #8 x 1-1/4"	25 34476  #8 x 1-1/2"	25 34477  #8 x 1-3/4"		
13	25 34494  #10 x 1"	25 34495  #10 x 1-1/4"	25 34496  #10 x 1-1/2"	17	18		
19	25 34510  #12 x 1"	25 34511  #12 x 1-1/4"	25 34512  #12 x 1-1/2"	23	25 34522  #14 x 1-1/2"		

CD - 132 Cotter Pins
 99937 20 Space Tray
 99936 Outside Shell

CHOICE
CHOICE
 DISTRIBUTION INC.
www.choice-distribution.com









CHOICE DISTRIBUTION		CD-132 Cotter Pins		111 BELL STREET W. BABYLON, NY 11704 (516) 756-0120	
50	48210	1		1/16" x 1	
50	48214	2		1/16" x 2	
50	48217	3		3/32" x 1	
50	48221	4		3/32" x 2	
50	48226	5		7/64" x 1 1/2"	
50	48228	6		7/64" x 2	
50	48231	7		1/8" x 1 1/2"	
50	48233	8		1/8" x 2	
50	48235	9		1/8" x 3	
25	48239	10		5/32" x 1 1/2"	
25	48241	11		5/32" x 2	
25	48244	12		5/32" x 3	
		13			
25	48246	14		3/16" x 1	
		15			
		16			
25	48250	17		3/16" x 2	
25	48253	18		3/16" x 3	
		19			
25	48263	20		1/4" x 3	

CD - 134 Hex Head Concrete Screws 99905 Adjustable Space Tray



DISTRIBUTION INC.
www.choice-distribution.com

Add Installation tool #53050, #53051, #53060, #53061. One of Each

CHOICE DISTRIBUTION		CD-134 Hex Head Concrete Screws		111 BELL STREET W. BABYLON, NY 11704 (516) 756-0120	
<p>53000</p> <p>25</p> 	<p>53001</p> <p>25</p> 	<p>53002</p> <p>25</p> 	<p>53003</p> <p>25</p> 		
<p>3/16 x 1-1/4 Use with #53050 installation tool. 5/32 x 3-1/2</p>	<p>3/16 x 1-3/4 Use with #53050 installation tool. 5/32 x 3-1/2</p>	<p>3/16 x 2-1/4 Use with #53051 installation tool. 5/32 x 4-1/2</p>	<p>3/16 x 2-3/4 Use with #53051 installation tool. 5/32 x 4-1/2</p>		
<p>53010</p> <p>25</p> 	<p>53011</p> <p>25</p> 	<p>53012</p> <p>25</p> 	<p>53013</p> <p>25</p> 		
<p>1/4 x 1-1/4 Use with #53060 installation tool. 3/16 x 3-1/2</p>	<p>1/4 x 1-3/4 Use with #53060 installation tool. 3/16 x 3-1/2</p>	<p>1/4 x 2-1/4 Use with #53061 installation tool. 3/16 x 4-1/2</p>	<p>1/4 x 2-3/4 Use with #53061 installation tool. 3/16 x 4-1/2</p>		

CD - 135 Flat Head Concrete Screws 99905 Adjustable Space Tray

CHOICE CHOICE

DISTRIBUTION INC.
www.choice-distribution.com

Add Installation tool #53050, #53051, #53060, #53061. One of Each

111 BELL STREET
W. BABYLON, NY 11704
(516) 756-0120

**CHOICE
DISTRIBUTION**

CD-135 Flat Head Concrete Screws

53020

25



3/16 x 1-1/4
Use with #53050
installation tool.
5/32 x 3-1/2

53021

25



3/16 x 1-3/4
Use with #53050
installation tool.
5/32 x 3-1/2

53022

25



3/16 x 2-1/4
Use with #53051
installation tool.
5/32 x 4-1/2

53023

25



3/16 x 2-3/4
Use with #53051
installation tool.
5/32 x 4-1/2

53030

25



1/4 x 1-1/4
Use with #53060
installation tool.
3/16 x 3-1/2

53031

25



1/4 x 1-3/4
Use with #53060
installation tool.
3/16 x 3-1/2

53032

25



1/4 x 2-1/4
Use with #53061
installation tool.
3/16 x 4-1/2

53033





25



1/4 x 2-3/4
Use with #53061
installation tool.
3/16 x 4-1/2

CD - 136 Flat Head Concrete Screws
99905 Adjustable Space Tray

Add Installation tool #53051, #53052, #53061, #53062. One of Each





CHOICE DISTRIBUTION	CD-136 Flat Head Concrete Screws			111 BELL STREET W. BABYLON, NY 11704 (516) 756-0120
<p data-bbox="231 495 441 584">25 53024</p>  <p data-bbox="304 812 567 974">3/16 x 3-1/4 Use with #53051 installation tool. 5/32 x 4-1/2</p>	<p data-bbox="682 495 892 584">25 53025</p>  <p data-bbox="745 812 1008 974">3/16 x 3-3/4 Use with #53052 installation tool. 5/32 x 5-1/2</p>	<p data-bbox="1123 495 1333 584">25 53034</p>  <p data-bbox="1228 812 1491 974">1/4 x 3-1/4 Use with #53061 installation tool. 3/16 x 4-1/2</p>	<p data-bbox="1575 495 1785 584">25 53035</p>  <p data-bbox="1669 812 1932 974">1/4 x 3-3/4 Use with #53062 installation tool. 3/16 x 5-1/2</p>	

CD - 137 Hex Head Concrete Screws 99905 Adjustable Space Tray

























DISTRIBUTION INC.
www.choice-distribution.com

Add Installation tool #53051, #53052, #53061, #53062. One of Each

CHOICE DISTRIBUTION	CD-137 Hex Head Concrete Screws		111 BELL STREET W. BABYLON, NY 11704 (516) 756-0120
<p data-bbox="226 483 436 570">25 53004</p>  <p data-bbox="296 802 554 964">3/16 x 3-1/4 Use with #53051 installation tool. 5/32 x 4-1/2</p>	<p data-bbox="657 483 898 570">25 53005</p>  <p data-bbox="758 802 1016 964">3/16 x 3-3/4 Use with #53052 installation tool. 5/32 x 5-1/2</p>	<p data-bbox="1100 483 1362 570">25 53014</p>  <p data-bbox="1226 802 1484 964">1/4 x 3-1/4 Use with #53061 installation tool. 3/16 x 4-1/2</p>	<p data-bbox="1551 483 1793 570">25 53015</p>  <p data-bbox="1656 802 1915 964">1/4 x 3-3/4 Use with #53062 installation tool. 3/16 x 5-1/2</p>

CD - 138 Vinyl Insulated Terminals
99902 24 Space Tray

CHOICE DISTRIBUTION	CD-138 Insulated Terminals					111 BELL STREET W. BABYLON, NY 11704 (631) 756-0120
<p>66097 ¹  (25)</p> <p>QUICK DISCONNECT FEMALE PUSH ON 16-14 WIRE SIZE .250 TAB SIZE</p>	<p>66098 ²  (25)</p> <p>QUICK DISCONNECT MALE PUSH ON 16-14 WIRE SIZE .250 TAB SIZE</p>	<p>66000 ³  (25)</p> <p>RING TONGE 22-16 WIRE SIZE NO. 4-6 STUD SIZE</p>	<p>66003 ⁴  (25)</p> <p>RING TONGE 22-16 WIRE SIZE NO. 8-10 STUD SIZE</p>	<p>66009 ⁵  (25)</p> <p>SPADE TONGE 22-16 WIRE SIZE NO. 8-10 STUD SIZE</p>	<p>66014 ⁶  (25)</p> <p>BUTT CONNECTOR 22-16 WIRE SIZE</p>	
<p>66021 ⁷  (25)</p> <p>RING TONGE 16-14 WIRE SIZE NO. 4-6 STUD SIZE</p>	<p>66023 ⁸  (25)</p> <p>RING TONGE 16-14 WIRE SIZE NO. 8-10 STUD SIZE</p>	<p>66024 ⁹  (25)</p> <p>RING TONGE 16-14 WIRE SIZE 1/4" STUD SIZE</p>	<p>66033 ¹⁰  (25)</p> <p>HOOK TONGE 16-14 WIRE SIZE NO. 8-10 STUD SIZE</p>	<p>66029 ¹¹  (25)</p> <p>SPADE TONGE 16-14 WIRE SIZE NO. 8-10 STUD SIZE</p>	<p>66035 ¹²  (25)</p> <p>BUTT CONNECTOR 16-14 WIRE SIZE</p>	
<p>66061 ¹³  (25)</p> <p>RING TONGE 12-10 WIRE SIZE NO. 8-10 STUD SIZE</p>	<p>66062 ¹⁴  (25)</p> <p>RING TONGE 12-10 WIRE SIZE 1/4" STUD SIZE</p>	<p>66065 ¹⁵  (25)</p> <p>RING TONGE 12-10 WIRE SIZE 5/16"-3/8" STUD SIZE</p>	<p>66067 ¹⁶  (25)</p> <p>RING TONGE 12-10 WIRE SIZE 7/16"-1/2" STUD SIZE</p>	<p>66069 ¹⁷  (25)</p> <p>SPADE TONGE 12-10 WIRE SIZE NO. 8-10 STUD SIZE</p>	<p>66075 ¹⁸  (25)</p> <p>BUTT CONNECTOR 12-10 WIRE SIZE</p>	
<p>13086 ¹⁹  (25)</p> <p>QUICK DISCONNECT FEMALE PUSH ON 16-14 WIRE SIZE .250 TAB SIZE</p>	<p>13087 ²⁰  (25)</p> <p>QUICK DISCONNECT MALE PUSH ON 16-14 WIRE SIZE .250 TAB SIZE</p>	<p>13204 ²¹  (25)</p> <p>SELF STRIPPING SCOTCHLOK 18-14 WIRE SIZE BLUE</p>	<p>13213 ²²  (25)</p> <p>T-TAP CONNECTOR BLUENYLON 12-10 WIRE SIZE</p>	<p>²³</p>	<p>66099 ²⁴  (25)</p> <p>BLUE BULLET 16-14 WIRE SIZE .157 SNAP DIA.</p>	

CD - 139 MULTI-WIRE CONNECTORS

99905 Adjustable Tray

CHOICE
DISTRIBUTION

CD-139 MULTI-WIRE CONNECTORS

111 BELL STREET
W. BABYLON, NY 11704
(631) 756-0120



**MULTI-WIRE
IN-LINE BUTT
CONNECTORS**

**51100
24-22 AWG**

25



**MULTI-WIRE
IN-LINE BUTT
CONNECTORS**

**51101
20-18 AWG**

25

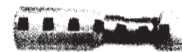

**MULTI-WIRE
IN-LINE BUTT
CONNECTORS**

**51102
16-14 AWG**

25



**MULTI-WIRE
IN-LINE BUTT
CONNECTORS**

**51103
12-10 AWG**

25



**MULTI-WIRE
CLOSED-END
CONNECTORS**

**51104
22-14 AWG**

25



**MULTI-WIRE
CLOSED-END
CONNECTORS**

**51105
18-10 AWG**

25



























**MULTI-PURPOSE
CRIMPER TOOL**

51106

1

CD - 140 Brass Compression Fittings

99902 24 Space Tray

CHOICE DISTRIBUTION		CD-140 BRASS COMPRESSION FITTINGS				111 BELL STREET W. BABYLON, NY 11704 (516) 756-0120					
		3/16, 1/4, 5/16									
10	90052 ¹	10	90053 ²	10	90054 ³	4	90113 ⁴	4	90114 ⁵	4	90081 ⁶
											
	3/16 COMPRESSION SLEEVE		1/4 COMPRESSION SLEEVE		5/16 COMPRESSION SLEEVE		3/16 tube x 1/8 pipe MALE COMPRESSION CONNECTOR		1/4 tube x 1/8 pipe MALE COMPRESSION CONNECTOR		3/16 COMPRESSION UNION
5	90061 ⁷	5	90062 ⁸	5	90063 ⁹	4	90115 ¹⁰	4	90116 ¹¹	4	90082 ¹²
											
	3/16 COMPRESSION NUT		1/4 COMPRESSION NUT		5/16 COMPRESSION NUT		1/4 tube x 1/4 pipe MALE COMPRESSION CONNECTOR		5/16 tube x 1/8 pipe MALE COMPRESSION CONNECTOR		1/4 COMPRESSION UNION
3	90132 ¹³	3	90133 ¹⁴	3	90134 ¹⁵	3	90135 ¹⁶	4	90117 ¹⁷	4	90083 ¹⁸
											
	3/16 tube x 1/8 pipe MALE COMPRESSION ELBOW		1/4 tube x 1/8 pipe MALE COMPRESSION ELBOW		1/4 tube x 1/4 pipe MALE COMPRESSION ELBOW		5/16 tube x 1/8 pipe MALE COMPRESSION ELBOW		5/16 tube x 1/4 pipe MALE COMPRESSION CONNECTOR		5/16 COMPRESSION UNION
3	90136 ¹⁹	3	90102 ²⁰	3	90103 ²¹	3	90104 ²²	3	90105 ²³	3	90106 ²⁴
											
	5/16 tube x 1/4 pipe MALE COMPRESSION ELBOW		3/16 tube x 1/8 pipe FEMALE COMPRESSION CONNECTOR		1/4 tube x 1/8 pipe FEMALE COMPRESSION CONNECTOR		1/4 tube x 1/4 pipe FEMALE COMPRESSION CONNECTOR		5/16 tube x 1/8 pipe FEMALE COMPRESSION CONNECTOR		5/16 tube x 1/4 pipe FEMALE COMPRESSION CONNECTOR

CD - 141 Brass Compression Fittings
 99937 20 Space Tray
 99936 Outside Shell

CHOICE DISTRIBUTION		CD-141 BRASS COMPRESSION FITTINGS 3/8 & 1/2		111 BELL STREET W. BABYLON, NY 11704 (516) 756-0120											
5	90055	1	3/8 COMPRESSION SLEEVE	5	90057	2	1/2 COMPRESSION SLEEVE	5	90064	3	3/8 COMPRESSION NUT	5	90066	4	1/2 COMPRESSION NUT
3	90084	5	3/8 COMPRESSION UNION	3	90086	6	1/2 COMPRESSION UNION	3	90118	7	3/8 tube x 1/4 pipe MALE COMPRESSION CONNECTOR	3	90119	8	3/8 tube x 1/8 pipe MALE COMPRESSION CONNECTOR
3	90120	9	3/8 tube x 3/8 pipe MALE COMPRESSION CONNECTOR	3	90121	10	3/8 tube x 1/2 pipe MALE COMPRESSION CONNECTOR	3	90123	11	1/2 tube x 3/8 pipe MALE COMPRESSION CONNECTOR	3	90124	12	1/2 tube x 1/4 pipe MALE COMPRESSION CONNECTOR
3	90125	13	1/2 tube x 1/2 pipe MALE COMPRESSION CONNECTOR	3	90137	14	3/8 tube x 1/4 pipe MALE COMPRESSION ELBOW	3	90138	15	3/8 tube x 1/8 pipe MALE COMPRESSION ELBOW	3	90139	16	3/8 tube x 3/8 pipe MALE COMPRESSION ELBOW
3	90140	17	3/8 tube x 1/2 pipe MALE COMPRESSION ELBOW	3	90142	18	1/2 tube x 3/8 pipe MALE COMPRESSION ELBOW	3	90143	19	1/2 tube x 1/4 pipe MALE COMPRESSION ELBOW	3	90144	20	1/2 tube x 1/2 pipe MALE COMPRESSION ELBOW

**CHOICE
DISTRIBUTION**

CD-142 TY-RAPS

111 BELL STREET
W. BABYLON, NY 11704
(631) 756-0120

50



6901

4" TY-RAP

WIDTH - .10

MIN. TENSILE STRENGTH 18 LBS.

BUNDLE DIAMETER .75

50

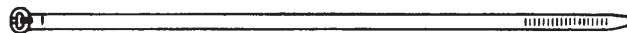

6903

5.6" TY-RAP

WIDTH - .14

MIN. TENSILE STRENGTH 40 LBS.

BUNDLE DIAMETER 1.25

50

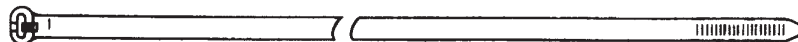

6904

7" TY-RAP

WIDTH - .19

MIN. TENSILE STRENGTH 50 LBS.

BUNDLE DIAMETER 2.0

50



6905

11.1" TY-RAP

WIDTH - .19

MIN. TENSILE STRENGTH 50 LBS.

BUNDLE DIAMETER 3.0

25

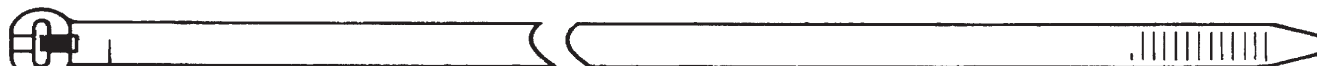

6907

14.25" TY-RAP

WIDTH - .30

MIN. TENSILE STRENGTH 120 LBS.

BUNDLE DIAMETER 4.0

25

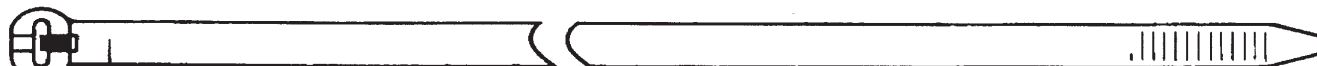

6907

14.25" TY-RAP

WIDTH - .30

MIN. TENSILE STRENGTH 120 LBS.

BUNDLE DIAMETER 4.0

CD - 143 Black Ty-raps
99906 Horizontal Tray

CHOICE
DISTRIBUTION

CD-143 BLACK TY-RAPS

111 BELL STREET
W. BABYLON, NY 11704
(631) 756-0120

50



6921 4" TY-RAP WIDTH - .10 MIN. TENSILE STRENGTH 18 LBS. BUNDLE DIAMETER .75

50



6923 5.6" TY-RAP WIDTH - .14 MIN. TENSILE STRENGTH 40 LBS. BUNDLE DIAMETER 1.25

50



6924 7" TY-RAP WIDTH - .19 MIN. TENSILE STRENGTH 50 LBS. BUNDLE DIAMETER 2.0

50



6925 11.1" TY-RAP WIDTH - .19 MIN. TENSILE STRENGTH 50 LBS. BUNDLE DIAMETER 3.0

25



6927 14.25" TY-RAP WIDTH - .30 MIN. TENSILE STRENGTH 120 LBS. BUNDLE DIAMETER 4.0















25



6927 14.25" TY-RAP WIDTH - .30 MIN. TENSILE STRENGTH 120 LBS. BUNDLE DIAMETER 4.0

CD - 144 SmartGlow Big & Small Fuses
 99937 20 Space Tray
 99936 Outside Shell

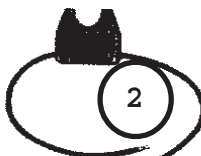
CHOICE
CHOICE
 DISTRIBUTION INC.
www.choice-distribution.com

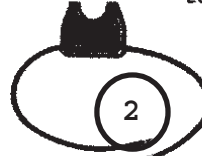





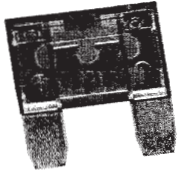
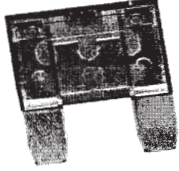

CHOICE DISTRIBUTION		CD-144 SMARTGLOW BIG & SMALL FUSES		111 BELL STREET W. BABYLON, NY 11704 (631) 756-0120	
37940 3 AMP Violet	 1 5	37946 20 AMP Yellow	 2 5	37930 3 AMP Violet	 3 5
37942 5 AMP Tan	 5 5	37947 25 AMP White	 6 5	37932 5 AMP Tan	 7 5
37943 7-1/2 AMP Brown	 9 5	37948 30 AMP Lt. Green	 10 5	37933 7-1/2 AMP Brown	 11 5
37944 10 AMP Red	 13 5			37934 10 AMP Red	 15 5
37945 15 AMP Lt. Blue	 17 5	37956 In Line Big Blade Fuse Holder	 18 2	37935 15 AMP Lt. Blue	 19 5
				37955 In Line Small Blade Fuse Holder	 20 2

CD - 145 SmartGlow MAXI & Small Fuses
99903 16 Space Tray

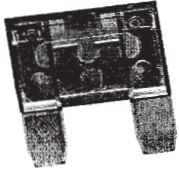
CHOICE
DISTRIBUTION

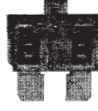
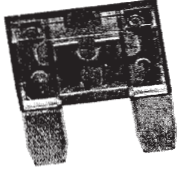
CD-145 SMARTGLOW™ MAXI & SMALL FUSES

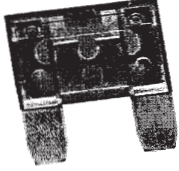
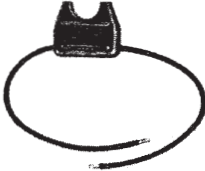
111 BELL STREET
W. BABYLON, NY 11704
(631) 756-0120

<p>1</p> <p>37920 20 AMP Yellow</p>  <p>2</p>	<p>2</p> <p>37924 60 AMP Blue</p>  <p>2</p>	<p>3</p> <p>37930 3 AMP Violet</p>  <p>5</p>	<p>4</p> <p>37935 15 AMP Lt. Blue</p>  <p>5</p>
<p>5</p> <p>37921 30 AMP Green</p>  <p>2</p>	<p>6</p>	<p>7</p> <p>37932 5 AMP Tan</p>  <p>5</p>	<p>8</p> <p>37936 20 AMP Yellow</p>  <p>5</p>
<p>9</p> <p>37922 40 AMP Orange</p>  <p>2</p>	<p>10</p>	<p>11</p> <p>37933 7-1/2 AMP Brown</p>  <p>5</p>	<p>12</p> <p>37937 25 AMP White</p>  <p>5</p>
<p>13</p> <p>37923 50 AMP Red</p>  <p>2</p>	<p>14</p> <p>37955 In Line Small Blade Fuse Holder</p>  <p>2</p>	<p>15</p> <p>37934 10 AMP Red</p>  <p>5</p>	<p>16</p> <p>37938 30 AMP Lt. Green</p>  <p>5</p>

**CHOICE
DISTRIBUTION**

CD-146 Battery Slugs

111 BELL STREET
W. BABYLON, NY 11704
(516) 756-0120

**1 GAUGE SOLDER SLUG
PINK**

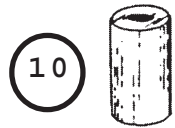

57252

**2/0 GAUGE SOLDER SLUG
ORANGE**

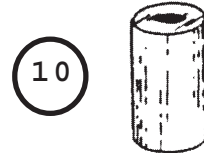

57254

**4/0 GAUGE SOLDER SLUG
YELLOW**

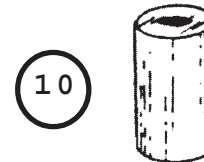

57256

**2 GAUGE SOLDER SLUG
GREEN**

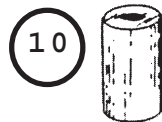

57251

**1/0 GAUGE SOLDER SLUG
BLACK**

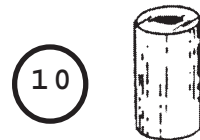

57253

**3/0 GAUGE SOLDER SLUG
PURPLE**

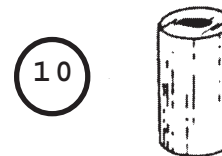

57255

**4 GAUGE SOLDER SLUG
GREY**

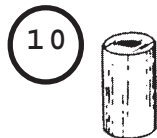

57250

1

FLUX



"NO - CLEAN" FLUX FOR PREPAR-
ING CABLE FOR THE SOLDERING

PROCESS











30419

CD - 147 Moisture Proof Butt Connectors

99903 16 Space Tray

CHOICE DISTRIBUTION		CD147 Moisture Proof Butt Connectors		111 BELL STREET W. BABYLON, NY 11704 (516) 756-0120	
10	12899	10	57220	5	57230
22-24 WIRE SIZE HEAT SHRINK W/MASTIC	22-18 WIRE SIZE FILLED W/ CORROSION PREVENTING COMPOUND	22-18 WIRE SIZE HEAT SHRINK PLUS SOLDER CONNECTION	16-20 TO 12-14 WIRE SIZE STEP DOWN BUTT HEAT SHRINK W/MASTIC		
10	12900	10	57221	5	57231
22-18 WIRE SIZE HEAT SHRINK W/MASTIC	16-14 WIRE SIZE FILLED W/ CORROSION PREVENTING COMPOUND	16-14 WIRE SIZE HEAT SHRINK PLUS SOLDER CONNECTION	14-16 TO 10-12 WIRE SIZE STEP DOWN BUTT HEAT SHRINK W/MASTIC		
10	12901	10	57222	5	57232
16-14 WIRE SIZE HEAT SHRINK W/MASTIC	12-10 WIRE SIZE FILLED W/ CORROSION PREVENTING COMPOUND	12-10 WIRE SIZE HEAT SHRINK PLUS SOLDER CONNECTION	10-12 TO 8 WIRE SIZE STEP DOWN BUTT HEAT SHRINK W/MASTIC		
10	12902	3	13209		
12-10 WIRE SIZE HEAT SHRINK W/MASTIC	SEALANT FILLED MOISTURE PROOF CONNECTOR				

CD - 148 Mini Terminals (26-24)
99903 16 Space Tray

























CHOICE DISTRIBUTION		CD-148 Mini Terminals (26-24)		111 BELL STREET W. BABYLON, NY 11704 (631) 756-0120	
1		2	<p>13041</p> <p>25 </p> <p>RING TONGE 26-24 WIRE SIZE NO. 2 STUD SIZE</p>	3	<p>13042</p> <p>25 </p> <p>RING TONGE 26-24 WIRE SIZE NO. 4 STUD SIZE</p>
				4	<p>13043</p> <p>25 </p> <p>RING TONGE 26-24 WIRE SIZE NO. 6 STUD SIZE</p>
5	<p>13044</p> <p>25 </p> <p>RING TONGE 26-24 WIRE SIZE NO. 8 STUD SIZE</p>	6	<p>13045</p> <p>25 </p> <p>RING TONGE 26-24 WIRE SIZE NO. 10 STUD SIZE</p>	7	<p>13046</p> <p>25 </p> <p>SPADE TONGE 26-24 WIRE SIZE NO. 0 STUD SIZE</p>
				8	<p>13047</p> <p>25 </p> <p>SPADE TONGE 26-24 WIRE SIZE NO. 4 STUD SIZE</p>
9	<p>13048</p> <p>25 </p> <p>SPADE TONGE 26-24 WIRE SIZE NO. 6 STUD SIZE</p>	10	<p>13049</p> <p>25 </p> <p>FEMALE PUSH-ON 26-24 WIRE SIZE .110 TAB SIZE</p>	11	<p>13219</p> <p>25 </p> <p>INSULATED BUTT CONNECTOR 26-24 WIRE SIZE</p>
				12	<p>13218</p> <p>25 </p> <p>NON-INSULATED BUTT CONNECTOR 26-24 WIRE SIZE</p>
13		14		15	
				16	

CD - 149 Heat Shrink Terminals
 99937 20 Space Tray
 99936 Outside Shell

CHOICE
CHOICE
 DISTRIBUTION INC.
www.choice-distribution.com

CHOICE DISTRIBUTION		CD-149 HEAT SHRINK TERMINALS				111 BELL STREET W. BABYLON, NY 11704 (516) 756-0120					
10	12906	1	10	12910	2	10	12907	3	10	12900	4
	RING TONGUE 22-16 Wire 6-8 Stud Size RED			RING TONGUE 16-14 Wire 6-8 Stud Size BLUE			RING TONGUE 22-16 Wire 8-10 Stud Size RED			BUTT SPLICE 22-16 Wire RED	
10	12911	5	10	12916	6	10	12912	7	10	12901	8
	RING TONGUE 16-14 Wire 8-10 Stud Size BLUE			RING TONGUE 12-10 Wire 8-10 Stud Size YELLOW			RING TONGUE 16-14 Wire 12-1/4 Stud Size BLUE			BUTT SPLICE 16-14 Wire BLUE	
10	12917	9	10	12918	10	10	12928	11	10	12902	12
	RING TONGUE 12-10 Wire 12-1/4 Stud Size YELLOW			RING TONGUE 12-10 Wire 5/16 Stud Size YELLOW			SPADE TONGUE 12-10 Wire 8-10 Stud Size YELLOW			BUTT SPLICE 12-10 Wire YELLOW	
10	12923	13	10	12926	14	10	12933	15	10	12935	16
	SPADE TONGUE 22-16 Wire 8-10 Stud Size RED			SPADE TONGUE 16-14 Wire 8-10 Stud Size BLUE			FULLY INSULATED PUSH ON Female 16-14 Wire BLUE			FULLY INSULATED PUSH ON Female 12-10 Wire YELLOW	
10	12930	17	10	12931	18	10	12932	19	10	12934	20
	FULLY INSULATED PUSH ON Male 22-16 Wire RED			FULLY INSULATED PUSH ON Female 22-16 Wire RED			FULLY INSULATED PUSH ON Male 16-14 Wire BLUE			FULLY INSULATED PUSH ON Male 12-10 Wire YELLOW	

CD - 150 Solderless Terminals
99902 24 Space Tray

CHOICE DISTRIBUTION		CD-150 solderless terminals				711 BELL STREET W. BABYLON, NY 11704 (516) 756-0120	
<p>13097 (25)¹</p>  <p>QUICK DISCONNECT FEMALE PUSH ON 16-14 WIRE SIZE .250 TAB SIZE</p>	<p>13098 (25)²</p>  <p>QUICK DISCONNECT MALE PUSH ON 16-14 WIRE SIZE .250 TAB SIZE</p>	<p>13000 (25)³</p>  <p>RING TONGUE 22-16 WIRE SIZE NO. 4-6 STUD SIZE</p>	<p>13003 (25)⁴</p>  <p>RING TONGUE 22-16 WIRE SIZE NO. 8-10 STUD SIZE</p>	<p>13009 (25)⁵</p>  <p>SPADE TONGUE 22-16 WIRE SIZE NO. 8-10 STUD SIZE</p>	<p>(25) 13014 (6)</p>  <p>BUTT CONNECTOR 22-16 WIRE SIZE</p>		
<p>13021 (25)⁷</p>  <p>RING TONGUE 16-14 WIRE SIZE NO. 4-6 STUD SIZE</p>	<p>13023 (25)⁸</p>  <p>RING TONGUE 16-14 WIRE SIZE NO. 8-10 STUD SIZE</p>	<p>13024 (25)⁹</p>  <p>RING TONGUE 16-14 WIRE SIZE 1/4" STUD SIZE</p>	<p>13033 (25)¹⁰</p>  <p>HOOK TONGUE 16-14 WIRE SIZE NO. 8-10 STUD SIZE</p>	<p>13029 (25)¹¹</p>  <p>SPADE TONGUE 16-14 WIRE SIZE NO. 8-10 STUD SIZE</p>	<p>(25) 13035 (12)</p>  <p>BUTT CONNECTOR 16-14 WIRE SIZE</p>		
<p>13061 (25)¹⁸</p>  <p>RING TONGUE 12-10 WIRE SIZE NO. 8-10 STUD SIZE</p>	<p>13062 (25)⁴</p>  <p>RING TONGUE 12-10 WIRE SIZE 1/4" STUD SIZE</p>	<p>13065 (25)¹⁹</p>  <p>RING TONGUE 12-10 WIRE SIZE 5/16"-3/8" STUD SIZE</p>	<p>13067 (25)¹⁶</p>  <p>RING TONGUE 12-10 WIRE SIZE 7/16"-1/2" STUD SIZE</p>	<p>13069 (25)</p>  <p>SPADE TONGUE 12-10 WIRE SIZE NO. 8-10 STUD SIZE</p>	<p>(25) 13075 (18)</p>  <p>BUTT CONNECTOR 12-10 WIRE SIZE</p>		
<p>13086 (25)¹⁹</p>  <p>FULLY INSUL. CONN. 16-14 GA. WIRE</p>	<p>13087 (25)²⁰</p>  <p>FULLY INSUL. CONN. 16-14 GA. WIRE</p>	<p>13204 (25)²¹</p>  <p>CONNECTOR SELF STRIPPING SCOTCHLOK 801 18-14 GA. WIRE BLUE</p>	<p>13213 (25)²²</p>  <p>T-Tap Connector Blue Nylon Insulation 18-14 GA. WIRE</p>	<p>13101 (25)²³</p>  <p>BULLET 16-14 GA. WIRE BLUE .157 SNAP DIA.</p>	<p>(25) 13099 (24)</p>  <p>SNAP PLUG 16-14 WIRE SIZE .157 SNAP DIA.</p>		

CD - 151 Heat Shrink & Solder Terminals
 99937 20 Space Tray
 99936 Outside Shell

CHOICE
CHOICE
 DISTRIBUTION INC.
www.choice-distribution.com

CHOICE DISTRIBUTION		CD-151 Heat Shrink & Solder Terminals				111 BELL STREET W. BABYLON, NY 11704 (516) 756-0120					
10	57906	1	10	57910	2	10	57907	3	10	13230	4
	RING TONGUE 20-18 Wire 6-8 Stud Size RED			RING TONGUE 16-14 Wire 6-8 Stud Size BLUE			RING TONGUE 20-18 Wire 8-10 Stud Size RED			BUTT SPLICE 20-18 Wire RED	
10	57911	5	10	57916	6	10	57912	7	10	13231	8
	RING TONGUE 16-14 Wire 8-10 Stud Size BLUE			RING TONGUE 12-10 Wire 8-10 Stud Size YELLOW			RING TONGUE 16-14 Wire 12-1/4 Stud Size BLUE			BUTT SPLICE 16-14 Wire BLUE	
10	57917	9	10	57918	10	10	57928	11	10	13232	12
	RING TONGUE 12-10 Wire 12-1/4 Stud Size YELLOW			RING TONGUE 12-10 Wire 5/16 Stud Size YELLOW			SPADE TONGUE 12-10 Wire 8-10 Stud Size YELLOW			BUTT SPLICE 12-10 Wire YELLOW	
10	57923	13	10	57926	14	10	57933	15	10	57935	16
	SPADE TONGUE 20-18 Wire 8-10 Stud Size RED			SPADE TONGUE 16-14 Wire 8-10 Stud Size BLUE			FULLY INSULATED PUSH ON Female 16-14 Wire BLUE			FULLY INSULATED PUSH ON Female 12-10 Wire YELLOW	
10	57961	17	10	57931	18	10	57963	19	10	57965	20
	FULLY INSULATED PUSH ON Male 20-18 Wire RED			FULLY INSULATED PUSH ON Female 20-18 Wire RED			FULLY INSULATED PUSH ON Male 16-14 Wire BLUE			FULLY INSULATED PUSH ON Male 12-10 Wire YELLOW	

CD - 152 Connectors & Fully Insulated Quick Disconnects
 (Nylon Insulated)
 99903 16 Space Tray













CHOICE
CHOICE

DISTRIBUTION INC.
www.choice-distribution.com

215K CENTRAL AVENUE
 FARMINGDALE, NY 11735
 (516) 756-0120























CHOICE
DISTRIBUTION

CD-152 connectors & fully insulated
 quick disconnects (NYLON Insulated)

<p>13084 1</p>  <p>25</p> <p>QUICK DISCONNECT FULLY INSU. MALE 22-18 WIRE SIZE</p>	<p>13085 2</p>  <p>25</p> <p>QUICK DISCONNECT FULLY INSU. FEMALE 22-18 WIRE SIZE</p>	<p>13217 3</p>  <p>25</p> <p>QUICK DISCONNECT PIGGY-BACK 22-18 WIRE SIZE .250 TAB SIZE</p>	<p>4</p> 
<p>13086 5</p>  <p>25</p> <p>QUICK DISCONNECT FULLY INSU. MALE 16-14 WIRE SIZE</p>	<p>13087 6</p>  <p>25</p> <p>QUICK DISCONNECT FULLY INSU. FEMALE 16-14 WIRE SIZE</p>	<p>7</p>	<p>13216 8</p>  <p>25</p> <p>QUICK DISCONNECT PIGGY-BACK 16-14 WIRE SIZE .250 TAB SIZE</p>
<p>13087-2 9</p>  <p>25</p> <p>QUICK DISCONNECT FULLY INSU. MALE 12-10 WIRE SIZE</p>	<p>13087-1 10</p>  <p>25</p> <p>QUICK DISCONNECT FULLY INSU. FEMALE 12-10 WIRE SIZE</p>	<p>13099 11</p>  <p>25</p> <p>SNAP PLUG 16-14 WIRE SIZE .157 SNAP DIA. FOR USE W/ No. 13101</p>	<p>13101 12</p>  <p>25</p> <p>SNAP PLUG RECEPTACLE 16-14 WIRE SIZE .157 SNAP DIA. FOR USE W/ No. 13099</p>
<p>13</p>	<p>13213 14</p>  <p>25</p> <p>T-TAP CONNECTOR BLUE NYLON INSULATION 18-14 WIRE SIZE</p>	<p>15</p>	<p>13204 16</p>  <p>10</p> <p>INSTANT CONNECTOR "U" ELEMENT 18-14 WIRE SIZE</p>















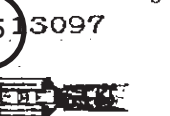
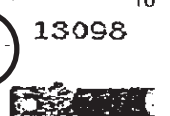
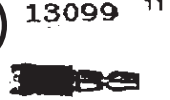
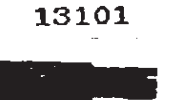

CD - 153 Nylon Insulated Terminals

99902 24 Space Tray



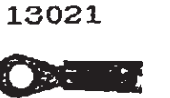



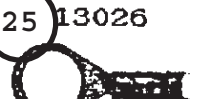
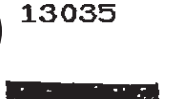







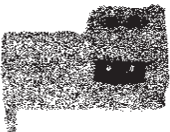

CHOICE DISTRIBUTION		CD-153 Nylon Insulated Terminals (22-16 Wire Ga.)				111 BELL STREET W. BABYLON, NY 11704 (631) 756-0120	
<p>13332¹ 25</p>  <p>End Cap Two No. 18 Wires Thru Two No. 16 Wires</p>	<p>13084² 25</p>  <p>Male Push-On Fully Insulated .250 x .032 Tab 22-18 Wire Size</p>	<p>13085³ 25</p>  <p>Female Push-On Fully Insulated For .250 x .032 Tab 22-18 Wire Size</p>	<p>13217⁴ 25</p>  <p>Quick Disconnect Piggy Back .250 x .032 Tab 22-28 Wire Size</p>	<p>13015⁵ 10</p>  <p>3 Way Connector 22-16 Wire Size</p>	<p>13200⁶ 10</p>  <p>Instant Connector "U" Element Run 18-14 Wire Si Tap 22-14 Wire Size</p>		
<p>13012⁷ 25</p>  <p>Hook Tongue 4-6 Stud Size 22-16 Wire Size</p>	<p>8</p>	<p>13092⁹ 25</p>  <p>QUICK DISCONNECT FEMALE PUSH ON 16-14 Wire Size .250 Tab Size</p>	<p>13081¹⁰ 25</p>  <p>QUICK DISCONNECT MALE PUSH ON 16-14 Wire Size .250 Tab Size</p>	<p>13207¹¹ 25</p>  <p>Bullet Receptacle For .157 Snap Plug 22-18 Wire Size</p>	<p>13195¹² 25</p>  <p>Snap Plug .157 Snap Dia. 22-18 Wire Size</p>		
<p>13007¹³ 25</p>  <p>Spade Tongue 4-6 Stud Size 22-16 Wire Size</p>	<p>13009¹⁴ 25</p>  <p>Spade Tongue 8-10 Stud Size 22-16 Wire Size</p>	<p>10</p> <p>13214¹⁵</p>  <p>Red Tee Tap 18-14 Wire</p>	<p>16</p>	<p>13010¹⁷ 25</p>  <p>Flanged Block Spade 4-6 Stud Size 22-16 Wire Size</p>	<p>13011¹⁸ 25</p>  <p>Flanged Block Spade 8-10 Stud Size 22-16 Wire Size</p>		
<p>13000¹⁹ 25</p>  <p>Ring Tongue 4-6 Stud Size 22-26 Wire Size</p>	<p>13001²⁰ 25</p>  <p>Ring Tongue 4-6 Stud Size 22-16 Wire Size</p>	<p>13002²¹ 25</p>  <p>Ring Tongue 6-8 Stud Size 22-16 Wire Size</p>	<p>13003²² 25</p>  <p>Ring Tongue 8-10 Stud Size 22-16 Wire Size</p>	<p>13004²³ 25</p>  <p>Ring Tongue 1/4" Stud Size 22-16 Wire Size</p>	<p>13014²⁴ 25</p>  <p>Butt Connector 22-16 Wire Size</p>		

CD - 154 Nylon Insulated Terminals 99902 24 Space Tray

**CHOICE
CHOICE**
DISTRIBUTION INC.
www.choice-distribution.com

CHOICE DISTRIBUTION		CD-154 nylon insulated terminals (16-14 wire ga.)				111 BELL STREET W. BABYLON, NY 11704 (516) 756-0120	
<p>25 13333 ¹</p>  <p>END CAP TWO NO. 18 WIRES THRU THREE NO. 14 WIRES</p>	<p>25 13086 ²</p>  <p>MALE PUSH-ON FULLY INSULATED .250 X .032 TAB 16-14 WIRE SIZE</p>	<p>25 13087 ³</p>  <p>FEMALE PUSH-ON FULLY INSULATED FOR .250 X .032 TAB 16-14 WIRE SIZE</p>	<p>25 13216 ⁴</p>  <p>QUICK DISCONNECT PIGGY BACK .250 X .032 TAB 16-14 WIRE SIZE</p>	<p>10 13036 ⁵</p>  <p>3 WAY CONNECTOR 16-14 WIRE SIZE</p>	<p>10 13204 ⁶</p>  <p>INSTANT CONNECTOR "U" ELEMENT 18-14 WIRE SIZE</p>		
<p>25 13032 ⁷</p>  <p>HOOK TONGUE 4-6 STUD SIZE 16-14 WIRE SIZE</p>	<p>25 13033 ⁸</p>  <p>HOOK TONGUE 8-10 STUD SIZE 16-14 WIRE SIZE</p>	<p>25 13097 ⁹</p>  <p>QUICK DISCONNECT FEMALE PUSH ON 16-14 WIRE SIZE .250 TAB SIZE</p>	<p>25 13098 ¹⁰</p>  <p>QUICK DISCONNECT MALE PUSH ON 16-14 WIRE SIZE .250 TAB SIZE</p>	<p>25 13099 ¹¹</p>  <p>SNAP PLUG .157 SNAP DIA. 16-14 WIRE SIZE</p>	<p>25 13101 ¹²</p>  <p>BULLET RECEPTACLE FOR .157 SNAP PLUG 16-14 WIRE SIZE</p>		
<p>25 13027 ¹³</p>  <p>SPADE TONGUE 4-6 STUD SIZE 16-14 WIRE SIZE</p>	<p>25 13029 ¹⁴</p>  <p>SPADE TONGUE 8-10 STUD SIZE 16-14 WIRE SIZE</p>	<p>10 13213 ¹⁵</p>  <p>T-Tap Connector Blue Nylon Insulation 18-14 GA. Wire</p>	<p>16</p>	<p>25 13020 ¹⁷</p>  <p>RING TONGUE 4-6 STUD SIZE 16-14 WIRE SIZE</p>	<p>25 13021 ¹⁸</p>  <p>RING TONGUE 4-6 STUD SIZE 16-14 WIRE SIZE</p>		
<p>25 13022 ¹⁹</p>  <p>RING TONGUE 6-8 STUD SIZE 16-14 WIRE SIZE</p>	<p>25 13023 ²⁰</p>  <p>RING TONGUE 8-10 STUD SIZE 16-14 WIRE SIZE</p>	<p>25 13024 ²¹</p>  <p>RING TONGUE 1/4" STUD SIZE 16-14 WIRE SIZE</p>	<p>25 13025 ²²</p>  <p>RING TONGUE 5/16" STUD SIZE 16-14 WIRE SIZE</p>	<p>25 13026 ²³</p>  <p>RING TONGUE 3/8" STUD SIZE 16-14 WIRE SIZE</p>	<p>25 13035 ²⁴</p>  <p>BUTT CONNECTOR 16-14 WIRE SIZE</p>		

CD - 155 Nylon Insulated Terminals
99902 24 Space Tray

CHOICE DISTRIBUTION		CD-155 NYLON INSULATED TERMINALS (12-10 wire ga.)				111 BELL STREET W. BABYLON, NY 11704 (631) 756-0120	
<p>13333 ¹ 25</p>  <p>END CAP TWO NO. 18 WIRES THRU TWO NO. 10 WIRES</p>	<p>13087-1 ² 25</p>  <p>FEMALE PUSH-ON FULLY INSULATED .250 X .032 TAB 12-10 WIRE SIZE</p>	<p>13087-2 ³ 25</p>  <p>MALE PUSH-ON FULLY INSULATED FOR .250 X .032 TAB 12-10 WIRE SIZE</p>	<p>⁴</p>	<p>13076 ⁵ 10</p>  <p>3 WAY CONNECTOR 12-10 WIRE SIZE</p>	<p>13205-1 ⁶ 10</p>  <p>INSTANT CONNECTOR "U" ELEMENT 12-10 WIRE SIZE</p>		
<p>13073 ⁷ 25</p>  <p>HOOK TONGUE 8-10 STUD SIZE 12-10 WIRE SIZE</p>	<p>13069 ⁸ 25</p>  <p>SPADE TONGUE 8-10 STUD SIZE 12-10 WIRE SIZE</p>	<p>⁹</p>	<p>13071 ¹⁰ 25</p>  <p>FLANGED BLOCK SPADE 8-10 STUD SIZE 12-10 WIRE SIZE</p>	<p>¹¹</p>	<p>13075 ¹² 25</p>  <p>BUTT CONNECTOR 12-10 WIRE SIZE</p>		
<p>¹³</p>	<p>¹⁴</p>	<p>13077-1 ¹⁵ 10</p>  <p>QUICK DISCONNECT MALE PUSH ON 12-10 WIRE SIZE .250 TAB SIZE</p>	<p>13077 ¹⁶ 25</p>  <p>QUICK DISCONNECT FEMALE PUSH ON 12-10 WIRE SIZE .250 TAB SIZE</p>	<p>¹⁷</p>	<p>¹⁸</p>		
<p>13060 ¹⁹ 25</p>  <p>RING TONGUE 6-8 STUD SIZE 12-10 WIRE SIZE</p>	<p>13061 ²⁰ 25</p>  <p>RING TONGUE 8-10 STUD SIZE 12-10 WIRE SIZE</p>	<p>13062 ²¹ 25</p>  <p>RING TONGUE 1/4" STUD SIZE 12-10 WIRE SIZE</p>	<p>13064 ²² 25</p>  <p>RING TONGUE 5/16" STUD SIZE 12-10 WIRE SIZE</p>	<p>13065 ²³ 25</p>  <p>RING TONGUE 3/8" STUD SIZE 12-10 WIRE SIZE</p>	<p>13067 ²⁴ 25</p>  <p>RING TONGUE 1/2" STUD SIZE 12-10 WIRE SIZE</p>		

CD - 156 Wire Connectors
99905 Adjustable Space Tray

**CHOICE
DISTRIBUTION**

CD-156 WIRE CONNECTORS

111 BELL STREET
W. BABYLON, NY 11704
(631) 756-0120

25

13875



Wire Nut
Grey Phenolic
Compound

25

13878



Wire Nut
Yellow Phenolic
Compound

10

13204



Connector
Blue Polypropylene

25

13876



Wire Nut
Blue Phenolic
Compound

25

13879



Wire Nut
Red Phenolic
Compound

10

13200



Connector
Red Polypropylene

10

13205-1

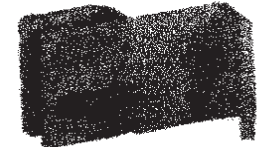

Connector
Yellow Polypropylene

25

13877



Wire Nut
Orange Phenolic
Compound

CHOICE
DISTRIBUTION

CD-157 BATTERY TERMINALS

111 BELL STREET
W. BABYLON, NY 11704
(516) 756-0120

10

57253



1/0

BATTERY SLUGS

10

57254



2/0

BATTERY SLUGS

1

FLUX
30419



"NO - CLEAN" FLUX FOR PREPARING
CABLE FOR THE SOLDERING
PROCESS
2 OZ BOTTLE

26024

3

1/0 Negative
Straight battery
cable connectors
copper with lead
plating.

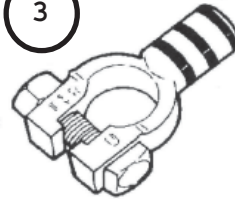

26014

3

1/0 Positive
Straight battery
cable connectors
copper with lead
plating.

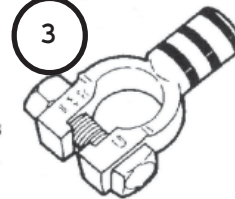

26025

3

2/0 Negative
Straight battery
cable connectors
copper with lead
plating.

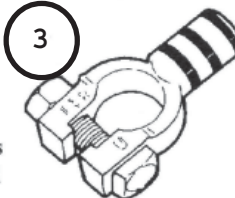

26015

3

2/0 Positive
Straight battery
cable connectors
copper with lead
plating.

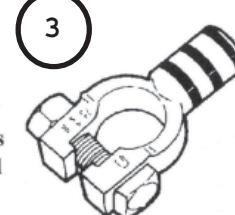

1

27013









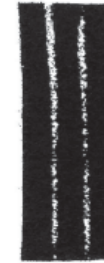

RED
HEAVY WALL HEAT
SHRINK TUBING
With Flexible Mastic Sealant

1

27003



BLACK
HEAVY WALL HEAT
SHRINK TUBING
With Flexible Mastic Sealant

CHOICE DISTRIBUTION	CD-158 TEST CLIPS			111 BELL STREET W. BABYLON, NY 11704 (516) 756-0120
<p data-bbox="210 472 411 532">10 13338</p>  <p data-bbox="226 797 527 873">PROBE BARREL RED</p>	<p data-bbox="632 472 877 532">5 13336</p>  <p data-bbox="669 769 999 889">INSULATED ALLIGATOR CLIP RED</p>	<p data-bbox="1108 472 1293 532">5 13341</p>  <p data-bbox="1136 786 1394 862">10 Amp UTILITY CLIP</p>	<p data-bbox="1549 472 1766 532">5 13342</p>  <p data-bbox="1577 789 1839 865">25 Amp UTILITY CLIP</p>	
<p data-bbox="191 992 411 1052">10 13339</p>  <p data-bbox="235 1300 537 1377">PROBE BARREL BLACK</p>	<p data-bbox="632 976 877 1036">5 13337</p>  <p data-bbox="669 1279 999 1399">INSULATED ALLIGATOR CLIP BLACK</p>	<p data-bbox="1108 976 1293 1036">10 13334</p>  <p data-bbox="1094 1312 1419 1349">ALLIGATOR CLIP</p>	<p data-bbox="1549 976 1755 1036">3 13343</p>  <p data-bbox="1577 1284 1839 1360">50 Amp UTILITY CLIP</p>	

**CHOICE
 DISTRIBUTION**

CD-159 BATTERY TERMINALS

5

23000-C



CAST LEAD
 8-4 GAUGE
 UNIVERSAL

5

23005-C

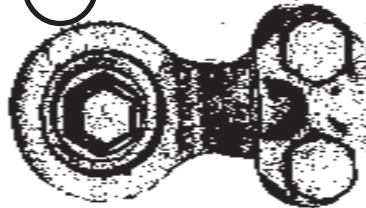

CAST LEAD
 8-10 GAUGE
 UNIVERSAL SIDE TERMINAL

1

23015-N



UNIVERSAL ORDINANCE
 BOLT TYPE TERMINAL
 NEGATIVE

2

23008



UNIVERSAL SIDE TERMINAL
 CONVERSION POST

3

23003-C



CAST LEAD
 2/0-4/0 GAUGE
 UNIVERSAL HD.

2

23004



CLAMP TYPE WING NUT
 MARINE TERMINAL

1

23015-P

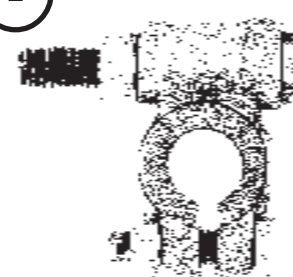

UNIVERSAL ORDINANCE
 BOLT TYPE TERMINAL
 POSITIVE

5

23040



3/8" O.E. REPLACEMENT SIDE
 TERMINAL BOLT

10

23001



BATTERY
 BOLT

5

23041













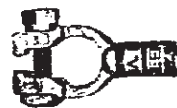

3/8" LONG EXTENDED
 O.E. REPLACEMENT SIDE
 TERMINAL BOLT

CD - 160 T & B Battery Terminals
99903 16 Space Tray



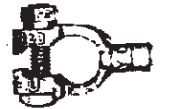











215K CENTRAL AVENUE
FARMINGDALE, NY 11735
(516) 756-0120

CHOICE
DISTRIBUTION

CD-160 T & B Battery Terminals

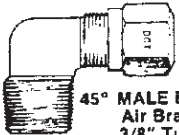
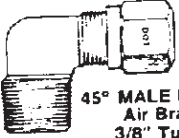
<p>3</p> <p>26003</p>  <p>BATTERY TERMINAL 1 GA. BATTERY CABLE UNIVERSAL</p> <p>1</p>	<p>5</p> <p>26053</p>  <p>BATTERY LUG 1 GA. BATTERY CABLE 3/8" STUD SIZE</p> <p>2</p>	<p>5</p> <p>26063</p>  <p>BATTERY LUG 1 GA. BATTERY CABLE 1/2" STUD SIZE</p> <p>3</p>	<p>5</p> <p>26073</p>  <p>BUTT CONNECTOR 1 GA. BATTERY CABLE</p> <p>4</p>
<p>3</p> <p>26002</p>  <p>BATTERY TERMINAL 2 GA. BATTERY CABLE UNIVERSAL</p> <p>5</p>	<p>5</p> <p>26052</p>  <p>BATTERY LUG 2 GA. BATTERY CABLE 3/8" STUD SIZE</p> <p>6</p>	<p>5</p> <p>26062</p>  <p>BATTERY LUG 2 GA. BATTERY CABLE 1/2" STUD SIZE</p> <p>7</p>	<p>5</p> <p>26072</p>  <p>BUTT CONNECTOR 2 GA. BATTERY CABLE</p> <p>8</p>
<p>3</p> <p>26001</p>  <p>BATTERY TERMINAL 4 GA. BATTERY CABLE UNIVERSAL</p> <p>9</p>	<p>5</p> <p>26050-1</p>  <p>BATTERY LUG 4 GA. BATTERY CABLE 5/16" STUD SIZE</p> <p>10</p>	<p>5</p> <p>26051</p>  <p>BATTERY LUG 4 GA. BATTERY CABLE 3/8" STUD SIZE</p> <p>11</p>	<p>5</p> <p>26071</p>  <p>BUTT CONNECTOR 4 GA. BATTERY CABLE</p> <p>12</p>
<p>13</p>	<p>5</p> <p>26050</p>  <p>BATTERY LUG 4 GA. BATTERY CABLE 1/4" STUD SIZE</p> <p>14</p>	<p>15</p>	<p>16</p>

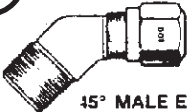
CD - 161 Air Brake Fittings
99903 16 Space Tray

CHOICE DISTRIBUTION		CD-161 Air brake fittings		215K CENTRAL AVENUE FARMINGDALE, NY 11735 (516) 756-0120											
25	90802	1		3	90872	2		3	90871	3		3	90870	4	
COMPRESSION SLEEVE 3/8" TUBE		MALE CONN. AIR BRAKE 3/8" Tube 3/8" Pipe		MALE CONN. AIR BRAKE 3/8" Tube 1/4" PIPE		MALE CONN. AIR BRAKE 3/8" TUBE 1/8" PIPE									
25	90891	5		3	90816	6		3	90815	7		3	90814	8	
INSERTS FOR 3/8" TUBING		FEMALE CONN. Air Brake 3/8" Tube 3/8" Pipe		FEMALE CONN. Air Brake 3/8" Tube 1/4" Pipe		FEMALE CONN. Air Brake 3/8" Tube 1/8" Pipe									
5	90851	9		3	90827	10		3	90826	11		3	90825	12	
NUT 3/8" TUBE		45° MALE ELBOW Air Brake 3/8" Tube 3/8" Pipe		45° MALE ELBOW Air Brake 3/8" Tube 1/4" Pipe		45° MALE ELBOW Air Brake 3/8" Tube 1/8" Pipe									
3	90808	13		3	90843	14		3	90844	15				16	
UNION AIR BRAKE 3/8" TUBE		45° MALE ELBOW Air Brake 3/8" Tube 3/8" Pipe		45° MALE ELBOW Air Brake 3/8" Tube 1/4" Pipe											







CD - 162 Air Brake Fittings
99903 16 Space Tray

CHOICE DISTRIBUTION		CD-162 Air brake fittings		215K CENTRAL AVENUE FARMINGDALE, NY 11735 (516) 756-0120	
5	90803	3	90878	3	90873
COMPRESSION SLEEVE 1/2" TUBE		MALE CONN. AIR BRAKE 1/2" TUBE 1/4" PIPE		MALE CONN. AIR BRAKE 1/2" TUBE 3/8" PIPE	
3	90874				
				MALE CONN. AIR BRAKE 1/2" TUBE 1/2" PIPE	
25	90892				
INSERTS FOR 1/2" TUBING				FEMALE CONN. Air Brake 1/2" Tube 1/2" Pipe	
5	90852	3	90829	3	90830
NUT 1/2" TUBE		AIR BRAKE 1/2" TUBE 1/4" PIPE		MALE ELBOW AIR BRAKE 1/2" TUBE 3/8" PIPE	
3	90831				
				MALE ELBOW AIR BRAKE 1/2" Tube 1/2" Pipe	
3	90809	3	90845		
UNION AIR BRAKE 1/2" TUBE		45° MALE ELBOW Air Brake 1/2" Tube 3/8" Pipe			



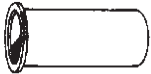

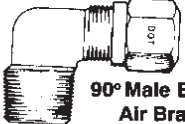
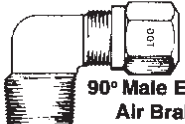









CHOICE
DISTRIBUTION

CD-163 1/4 AIR BRAKE FITTINGS

111 BELL STREET
W. BABYLON, NY 11704
(631) 756-0120





















<p>90801 1</p>  <p>Compression Sleeve 1/4" Tube</p> <p style="text-align: right;">25</p>	<p>90868 2</p>  <p>Male Conn. Air Brake 1/4" Tube 1/8" Pipe</p> <p style="text-align: right;">5</p>	<p>90869 3</p>  <p>Male Conn. Air Brake 1/4" Tube 1/4" Pipe</p> <p style="text-align: right;">5</p>	<p style="text-align: right;">4</p>
<p>90890 5</p>  <p>Inserts for 1/4" Tubing</p> <p style="text-align: right;">25</p>	<p style="text-align: right;">6</p>	<p style="text-align: right;">7</p>	<p style="text-align: right;">8</p>
<p>90850 9</p>  <p>Nut 1/4" Tube</p> <p style="text-align: right;">5</p>	<p>90823 10</p>  <p>90° Male Elbow Air Brake 1/4" Tube 1/8" Pipe</p> <p style="text-align: right;">5</p>	<p>90824 11</p>  <p>90° Male Elbow Air Brake 1/4" Tube 1/4" Pipe</p> <p style="text-align: right;">5</p>	<p style="text-align: right;">12</p>
<p>90807 13</p>  <p>Union Air Brake 1/4" Tube</p> <p style="text-align: right;">5</p>	<p>90840 14</p>  <p>45° Male Elbow Air Brake 1/4" Tube 1/8" Pipe</p> <p style="text-align: right;">5</p>	<p style="text-align: right;">15</p>	<p style="text-align: right;">16</p>

CD - 165 Brass Pipe Fitting
99903 16 Space Tray

CHOICE DISTRIBUTION	CD-165		Brass Pipe Fitting		215K CENTRAL AVENUE FARMINGDALE, NY 11735 (516) 756-0120
<p>4 90241 1</p>  <p>BUSHING 3/8" x 1/8" P.T.</p>	<p>2</p>	<p>4 90220 3</p>  <p>HEX HEAD PLUG 1/8" P.T.</p>	<p>4 90201 4</p>  <p>Cap 1/8" P.T.</p>		
<p>4 90240 5</p>  <p>BUSHING 1/4" x 1/8" P.T.</p>	<p>6</p>	<p>4 90221 7</p>  <p>HEX HEAD PLUG 1/4" P.T.</p>	<p>4 90203 8</p>  <p>Cap 1/4" P.T.</p>		
<p>4 90242 9</p>  <p>BUSHING 3/8" x 1/4" P.T.</p>	<p>4 90243 10</p>  <p>BUSHING 1/2" x 1/8" P.T.</p>	<p>4 90222 11</p>  <p>HEX HEAD PLUG 3/8" P.T.</p>	<p>4 90204 12</p>  <p>Cap 3/8" P.T.</p>		
<p>4 90245 13</p>  <p>BUSHING 1/2" x 3/8" P.T.</p>	<p>4 90244 14</p>  <p>BUSHING 1/2" x 1/4" P.T.</p>	<p>4 90223 15</p>  <p>HEX HEAD PLUG 1/2" P.T.</p>	<p>4 90204-1 16</p>  <p>Cap 1/2" P.T.</p>		

CD - 166 Brass Pipe Fittings
 99937 20 Space Tray
 99936 Outside Shell

CHOICE
CHOICE
 DISTRIBUTION INC.
www.choice-distribution.com

CHOICE DISTRIBUTION		CD-166 BRASS PIPE FITTINGS				111 BELL STREET W. BABYLON, NY 11704 (516) 756-0120					
4	90220	1	4	90221	2	4	90222	3	3	90223	4
											
HEX PIPE PLUG 1/8		HEX PIPE PLUG 1/4		HEX PIPE PLUG 3/8		HEX PIPE PLUG 1/2					
4	90265	5	4	90266	6	4	90268	7	3	90271	8
											
HEX PIPE NIPPLE 1/8		HEX PIPE NIPPLE 1/4		HEX PIPE NIPPLE 3/8		HEX PIPE NIPPLE 1/2					
4	90252	9	4	90253	10	4	90254	11	3	90255	12
											
HEX PIPE COUPLING 1/8		HEX PIPE COUPLING 1/4		HEX PIPE COUPLING 3/8		HEX PIPE COUPLING 1/2					
4	90335	13	4	90336	14	3	90337	15	3	90338	16
											
PIPE STREET ELBOW 1/8		PIPE STREET ELBOW 1/4		PIPE STREET ELBOW 3/8		PIPE STREET ELBOW 1/2					
4	90240	17	4	90241	18	4	90242	19	3	90245	20
											
PIPE BUSHING 1/8 x 1/4		PIPE BUSHING 1/8 x 3/8		PIPE BUSHING 1/4 x 3/8		PIPE BUSHING 3/8 x 1/2					

















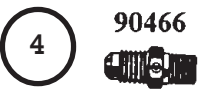

CD - 167 Brass Pipe Fittings
 99937 20 Space Tray
 99936 Outside Shell

CHOICE
CHOICE
 DISTRIBUTION INC.
www.choice-distribution.com

CHOICE DISTRIBUTION		CD-167 BRASS PIPE FITTINGS				111 BELL STREET W. BABYLON, NY 11704 (516) 756-0120					
3	90365 PIPE TEE 1/8	1	3	90366 PIPE TEE 1/4	2	3	90367 PIPE TEE 3/8	3	2	90368 PIPE TEE 1/2	4
2	90290 HEX PIPE LONG NIPPLE 1/8 x 1 1/2	5	2	90296 HEX PIPE LONG NIPPLE 1/4 x 2	6	2	90297 HEX PIPE LONG NIPPLE 3/8 x 2	7	2	90298 HEX PIPE LONG NIPPLE 1/2 x 2	8
4	90345 PIPE 90° ELBOW 1/8	9	4	90346 PIPE 90° ELBOW 1/4	10	3	90347 PIPE 90° ELBOW 3/8	11	3	90348 PIPE 90° ELBOW 1/2	12
3	90325 PIPE 45° STREET ELBOW 1/8	13	3	90326 PIPE 45° STREET ELBOW 1/4	14	3	90327 PIPE 45° STREET ELBOW 3/8	15	3	90328 PIPE 45° STREET ELBOW 1/2	16
3	90257 REDUCING COUPLING 1/8 x 1/4	17	3	90260 REDUCING COUPLING 1/8 x 3/8	18	3	90258 REDUCING COUPLING 1/4 x 3/8	19	3	90259 REDUCING COUPLING 3/8 x 1/2	20

CD - 168 Brass SAE Fittings
 99937 20 Space Tray
 99936 Outside Shell

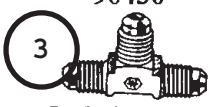















CHOICE
CHOICE
 DISTRIBUTION INC.
www.choice-distribution.com

CHOICE DISTRIBUTION		CD-168 BRASS SAE FITTINGS				111 BELL STREET W. BABYLON, NY 11704 (516) 756-0120	
1	 <p>90408 SAE NUT 3/16</p>	2	 <p>90409 SAE NUT 1/4</p>	3	 <p>90410 SAE NUT 5/16</p>	4	 <p>90422 SAE UNION 3/16</p>
5	 <p>90423 SAE UNION 1/4</p>	6	 <p>90424 SAE UNION 5/16</p>	7	 <p>90466 SAE MALE 3/16 tube - 1/8 pipe</p>	8	 <p>90467 SAE MALE 1/4 tube - 1/8 pipe</p>
9	 <p>90469 SAE MALE 5/16 tube - 1/8 pipe</p>	10	 <p>90470 SAE MALE 5/16 tube - 1/4 pipe</p>	11	 <p>90468 SAE MALE 1/4 tube - 1/4 pipe</p>	12	 <p>90486 SAE 90° ELBOW 3/16 tube - 1/8 pipe</p>
13	 <p>90487 SAE 90° ELBOW 1/4 tube - 1/8 pipe</p>	14	 <p>90490 SAE 90° ELBOW 5/16 tube - 1/8 pipe</p>	15	 <p>90491 SAE 90° SAE ELBOW 5/16 tube - 1/4 pipe</p>	16	 <p>90488 SAE 90° SAE ELBOW 1/4 tube - 1/4 pipe</p>
17	 <p>90430 SAE UNION TEE 3/16</p>	18	 <p>90431 SAE UNION TEE 1/4</p>	19	 <p>90432 SAE UNION TEE 5/16</p>	20	











CHOICE
DISTRIBUTION

CD-169 SAE BRASS FITTINGS

111 BELL STREET
W. BABYLON, NY 11704
(516) 756-0120





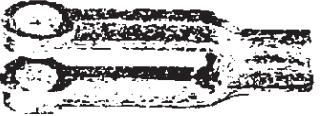

















<p>1</p> <p>4</p> <p>90412</p>  <p>SAE NUT 3/8</p>	<p>2</p> <p>4</p> <p>90414</p>  <p>SAE NUT 1/2</p>	<p>3</p> <p>4</p> <p>90425</p>  <p>SAE UNION 3/8</p>	<p>4</p> <p>4</p> <p>90426</p>  <p>SAE UNION 1/2</p>
<p>5</p> <p>3</p> <p>90472</p>  <p>SAE MALE 3/8 tube - 1/8 pipe</p>	<p>6</p> <p>3</p> <p>90471</p>  <p>SAE MALE 3/8 tube - 1/4 pipe</p>	<p>7</p> <p>3</p> <p>90473</p>  <p>SAE MALE 3/8 tube - 3/8 pipe</p>	<p>8</p> <p>3</p> <p>90477</p>  <p>SAE MALE 1/2 tube - 1/4 pipe</p>
<p>9</p> <p>3</p> <p>90476</p>  <p>SAE MALE 1/2 tube - 3/8 pipe</p>	<p>10</p> <p>3</p> <p>90493</p>  <p>SAE 90° ELBOW 3/8 tube - 1/8 pipe</p>	<p>11</p> <p>3</p> <p>90492</p>  <p>SAE 90° ELBOW 3/8 tube - 1/4 pipe</p>	<p>12</p> <p>3</p> <p>90494</p>  <p>SAE 90° ELBOW 3/8 tube - 3/8 pipe</p>
<p>13</p> <p>3</p> <p>90498</p>  <p>SAE 90° ELBOW 1/2 tube - 1/4 pipe</p>	<p>14</p> <p>3</p> <p>90497</p>  <p>SAE 90° ELBOW 1/2 tube - 3/8 pipe</p>	<p>15</p> <p>2</p> <p>90433</p>  <p>SAE UNION TEE 3/8</p>	<p>16</p> <p>2</p> <p>90434</p>  <p>SAE UNION TEE 1/2</p>

CD - 170 Clevis & Pins
99905 Adjustable Space Tray







CHOICE DISTRIBUTION	CD-170 clevis & pin *Illustration Not Actual Size		111 BELL STREET W. BABYLON, NY 11704 (516) 756-0120
<p>10 2300-1/4</p>  <p>Universal Clevis Pin 1/4 x 2"</p>	<p>5 2300-7/16 *</p>  <p>Universal Clevis Pin 7/16 x 2-1/2"</p>	<p>10 2120</p>  <p>Clevis Pin 1/4" x 3/4"</p>	<p>3 2132</p>  <p>Clevis For 1/4" Rod</p>
<p>10 2300-5/16</p>  <p>Universal Clevis Pin 3/16 x 2"</p>		<p>10 2121</p>  <p>Clevis Pin 5/16" x 7/8"</p>	<p>3</p>
<p>10 2300-3/8</p>  <p>Universal Clevis Pin 3/8 x 2"</p>	<p>10 2124</p>  <p>Clevis Pin 1/2 x 1-3/8"</p> <p>List</p>	<p>10 2122</p>  <p>Clevis Pin 3/8" x 1-1/8"</p>	<p>3 2133</p>  <p>Clevis For 5/16" Rod</p>
		<p>10 2123</p>  <p>Clevis Pin 7/16" x 1-1/4"</p>	<p>3 2134</p>  <p>Clevis For 3/8" Rod</p>

CHOICE DISTRIBUTION		CD-172 SLOTTED PINS				111 BELL STREET W. BABYLON, NY 11704 (516) 756-0120	
<p>44969 ¹</p> <p>25</p> <p>1/16" x 1/4"</p> <p>List</p>	<p>2</p>	<p>44982 ³</p> <p>25</p> <p>5/32" x 3/4"</p>	<p>44983 ⁴</p> <p>5</p> <p>5/32" x 1-1/4"</p>	<p>44987 ⁵</p> <p>5</p> <p>7/32" x 1-3/8"</p>	<p>44988 ⁶</p> <p>5</p> <p>7/32" x 1-3/4"</p>		
<p>44973 ⁷</p> <p>25</p> <p>5/64" x 9/16"</p>	<p>44974 ⁸</p> <p>25</p> <p>5/64" x 1-1/2"</p>	<p>44984-4 ⁹</p> <p>25</p> <p>3/16" x 3/4"</p>	<p>44990 ¹⁰</p> <p>5</p> <p>1/4" x 1-1/4"</p>	<p>44990-1 ¹¹</p> <p>5</p> <p>1/4" x 1-1/2"</p>	<p>44991 ¹²</p> <p>5</p> <p>1/4" x 2"</p>		
<p>44976 ¹³</p> <p>25</p> <p>3/32" x 5/8"</p>	<p>44977 ¹⁴</p> <p>25</p> <p>3/32" x 1-1/8"</p>	<p>44985 ¹⁵</p> <p>25</p> <p>3/16" x 1"</p>	<p>44985-2 ¹⁶</p> <p>5</p> <p>3/16" x 1-1/4"</p>	<p>44992-6 ¹⁷</p> <p>5</p> <p>5/16" x 1-1/4"</p>	<p>44993-2 ¹⁸</p> <p>5</p> <p>5/16" x 1-3/4"</p>		
<p>44979 ¹⁹</p> <p>25</p> <p>1/8" x 3/4"</p>	<p>44980 ²⁰</p> <p>25</p> <p>1/8" x 1-1/4"</p>	<p>44985-4 ²¹</p> <p>5</p> <p>3/16" x 1-1/2"</p>	<p>44992 ²²</p> <p>5</p> <p>5/16" x 3/4"</p>	<p>44993 ²³</p> <p>5</p> <p>5/16" x 1-1/2"</p>	<p>44993-4 ²⁴</p> <p>5</p> <p>5/16" x 2"</p>		

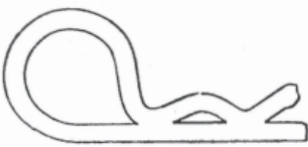



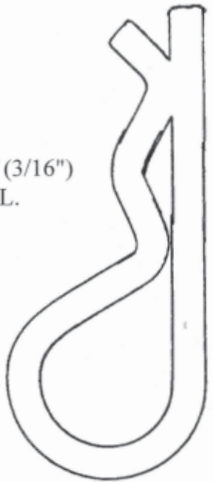
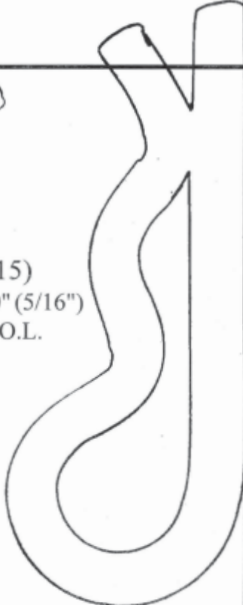



















CD - 174 Hairpin & e rings
99902 24 Space Tray

CHOICE DISTRIBUTION		CD-174 hairpin & "e" ring assortment				111 BELL STREET W. BABYLON, NY 11704 (516) 756-0120	
<p>45200 1</p>  <p>50 Groove Dia. 1/16 Length 23/64 Wire Ga. .026</p>	<p>45201 2</p>  <p>50 Groove Dia. 1/16 Length 7/16 Wire Ga. .035</p>	<p>45202 3</p>  <p>50 Groove Dia 1/16 Length 9/32 Wire Ga. .026</p>	<p>45205 4</p>  <p>50 Groove Dia. 3/32 Length 11/32 Wire Ga. .026</p>	<p>45207 5</p>  <p>50 Groove Dia. 9/64 Length 15/32 Wire Ga. .032</p>	<p>45204 6</p>  <p>50 Groove Dia. 7/64 Length 1 1/8 Wire Ga. .072</p>		
<p>45208 7</p>  <p>25 Groove Dia. 3/16 Length 5/8 Wire Ga. .047</p>	<p>45209 8</p>  <p>25 Groove Dia. 7/64 Length 3/4 Wire Ga. .051</p>	<p>45210 9</p>  <p>25 Groove Dia. 7/32 Length 11/16 Wire Ga. .062</p>	<p>45213 10</p>  <p>25 Groove Dia. 9/32 Length 53/64 Wire Ga. .062</p>	<p>45214 11</p>  <p>25 Groove Dia. 11/32 Length 1 Wire Ga. .062</p>			12
<p>45226 13</p>  <p>25 Shaft Dia. 3/32 Groove Dia. .074 Thickness .015</p>	<p>45228 14</p>  <p>25 Shaft Dia. 1/8 Groove Dia. .095 Thickness .015</p>	<p>45229 15</p>  <p>25 Shaft Dia. 9/64 Groove Dia. .105 Thickness .025</p>	<p>45230 16</p>  <p>25 Shaft Dia. 5/32 Groove Dia. .116 Thickness .025</p>	<p>45232 17</p>  <p>25 Shaft Dia. 3/16 Groove Dia. .147 Thickness .025</p>			18
<p>45233 19</p>  <p>25 Shaft Dia. 7/32 Groove Dia. .186 Thickness .025</p>	<p>45234 20</p>  <p>25 Shaft Dia. 1/4 Groove Dia. .210 Thickness .025</p>	<p>45236 21</p>  <p>25 Shaft Dia. 5/16 Groove Dia. .250 Thickness .025</p>	<p>45238 22</p>  <p>25 Shaft Dia. 3/8 Groove Dia. .303 Thickness .035</p>	<p>45239 23</p>  <p>25 Shaft Dia. 7/16 Groove Dia. .343 Thickness .035</p>	<p>45241 24</p>  <p>25 Shaft Dia. 1/2 Groove Dia. .396 Thickness .042</p>		

CD - 175 Hair Pin Cotters
99905 Adjustable Space Tray

CHOICE DISTRIBUTION	CD-175 Hair pin Cotters			111 BELL STREET W. BABYLON, NY 11704 (516) 756-0120
<p>20 45093 Wire Dia. - .105" Hole Size 1/8" 1-1/4 in. O.L.</p> 	<p>10 45104 Wire Dia. - .120" (1/8") 2 3/8 in. O.L.</p> 	<p>10 45112 Wire Dia. - .148" (5/32") 3 5/16 in. O.L.</p> 	<p>5 45117 (15) Wire Dia. - .250" (1/4") 4 in. O.L.</p> 	
<p>20 45092 Wire Dia. - .093" Hole Size 7/64" 1-1/8 in. O.L.</p> 	<p>10 45101 (25) Wire Dia. - .091" (3/32") 2 in. O.L.</p> 	<p>10 45115 Wire Dia. - .177" (3/16") 3 1/4 in. O.L.</p> 	<p>5 45120 (15) Wire Dia. - .310" (5/16") 3 15/16 in. O.L.</p> 	
<p>20 45090 Wire Dia. - .080" Hole Size 3/32" 1-9/16 in. O.L.</p> 	<p>10 45091 Wire Dia. - .093" Hole Size 7/64" 1-5/8 in. O.L.</p> 			

CD - 176 Woodruff Keys
99902 24 Space Tray





















CHOICE DISTRIBUTION		CD-176 Woodruff keys				215K CENTRAL AVENUE FARMINGDALE, NY 11735 (516) 756-0120	
<p>51003 1</p>  <p>1/8" x 1/2" (No. 3)</p>	<p>51006 2</p>  <p>5/32" x 5/8" (No. 6)</p>	<p>51010 3</p>  <p>3/16" x 3/4" (No. 9)</p>	<p>51015 4</p>  <p>3/16" x 2 1/8" RADIUS LENGTH (No. 126)</p>	<p>51021 5</p>  <p>1/4" x 1" (No. 15)</p>	<p>51026 6</p>  <p>5/16" x 1" (No. B)</p>		
<p>51000 7</p>  <p>1/8" x 3/8" (No. 213)</p>	<p>51005 8</p>  <p>1/8" x 3/4" (No. 7)</p>	<p>51011 9</p>  <p>3/16" x 7/8" (No. 11)</p>	<p>51019 10</p>  <p>1/4" x 3/4" (No. 91)</p>	<p>51020 11</p>  <p>1/4" x 1 1/8" (No. 18)</p>	<p>51028 12</p>  <p>5/16" x 1 1/4" (No. D)</p>		
<p>51004 13</p>  <p>1/8" x 5/8" (No. 5)</p>	<p>51007 14</p>  <p>5/32" x 3/4" (No. 8)</p>	<p>51012 15</p>  <p>3/16" x 1" (No. 13)</p>	<p>51016 16</p>  <p>7/32" x 7/8" (No. 12)</p>	<p>51023 17</p>  <p>1/4" x 1 1/4" (No. 21)</p>	<p>51030 18</p>  <p>3/8" x 1 1/4" (No. E)</p>		
<p>51001 19</p>  <p>3/32" x 5/8" (No. 4)</p>	<p>51009 20</p>  <p>3/16" x 5/8" (No. 61)</p>	<p>51014 21</p>  <p>3/16" x 1 1/4" (No. 19)</p>	<p>51029 22</p>  <p>1/4" x 7/8" (No. A)</p>	<p>51025 23</p>  <p>1/4" x 1 1/2" (No. 24)</p>	<p>51031 24</p>  <p>3/8" x 1 3/8" (No. F)</p>		

CD - 177 Internal Retaining Rings
99902 24 Space Tray

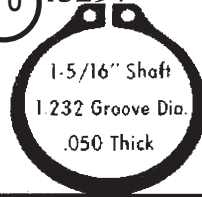
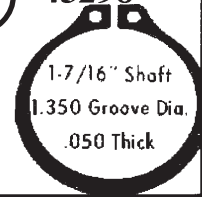
CHOICE
DISTRIBUTION

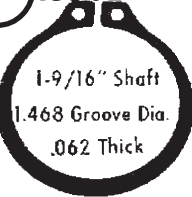
CD-177 Internal Retaining Rings

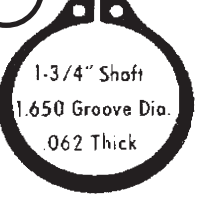
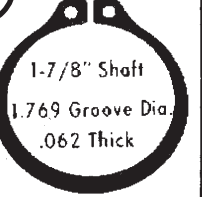

















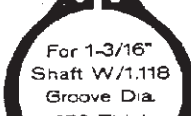
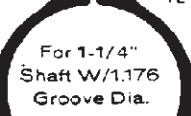

111 BELL STREET
W. BABYLON, NY 11704
(516) 756-0120

<p>25 45275¹</p>  <p>1/8" Shaft .117 Groove Dia. .010 Thick</p>	<p>25 45277²</p>  <p>3/16" Shaft .175 Groove Dia. .015 Thick</p>	<p>25 45278³</p>  <p>1/4" Shaft .230 Groove Dia. .025 Thick</p>	<p>25 45280⁴</p>  <p>5/16" Shaft .290 Groove Dia. .025 Thick</p>	<p>25 45282⁵</p>  <p>3/8" Shaft .352 Groove Dia. .025 Thick</p>	<p>45283 25⁶</p>  <p>7/16" Shaft .412 Groove Dia. .025 Thick</p>
<p>25 45285⁷</p>  <p>1/2" Shaft .468 Groove Dia. .035 Thick</p>	<p>25 45286⁸</p>  <p>9/16" Shaft .530 Groove Dia. .035 Thick</p>	<p>25 45288⁹</p>  <p>5/8" Shaft .588 Groove Dia. .035 Thick</p>	<p>25 45289¹⁰</p>  <p>11/16" Shaft .646 Groove Dia. .042 Thick</p>	<p>10 45290¹¹</p>  <p>3/4" Shaft .704 Groove Dia. .042 Thick</p>	<p>45291 10¹²</p>  <p>7/8" Shaft .821 Groove Dia. .042 Thick</p>
<p>10 45293¹³</p>  <p>1" Shaft .940 Groove Dia. .042 Thick</p>	<p>10 45295¹⁴</p>  <p>1-3/16" Shaft 1.118 Groove Dia. .050 Thick</p>	<p>10 45296¹⁵</p>  <p>1-1/4" Shaft 1.176 Groove Dia. .050 Thick</p>	<p>10 45297¹⁶</p>  <p>1-5/16" Shaft 1.232 Groove Dia. .050 Thick</p>	<p>10 45298¹⁷</p>  <p>1-7/16" Shaft 1.350 Groove Dia. .050 Thick</p>	<p>45299 10¹⁸</p>  <p>1-3/8" Shaft 1.291 Groove Dia. .050 Thick</p>
<p>10 45300¹⁹</p>  <p>1-1/2" Shaft 1.406 Groove Dia. .050 Thick</p>	<p>10 45301²⁰</p>  <p>1-9/16" Shaft 1.468 Groove Dia. .062 Thick</p>	<p>10 45302²¹</p>  <p>1-5/8" Shaft 1.529 Groove Dia. .062 Thick</p>	<p>10 45303²²</p>  <p>1-3/4" Shaft 1.650 Groove Dia. .062 Thick</p>	<p>10 45304²³</p>  <p>1-7/8" Shaft 1.769 Groove Dia. .062 Thick</p>	<p>45305 10²⁴</p>  <p>2" Shaft 1.886 Groove Dia. .062 Thick</p>

CD - 178 Internal & External Retaining Rings

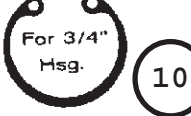
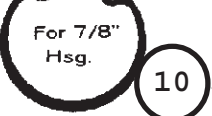
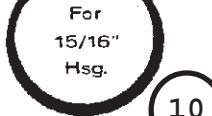

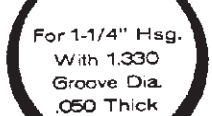



















99902 24 Space Tray

CHOICE
CHOICE
DISTRIBUTION INC.
www.choice-distribution.com



















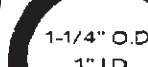

CHOICE DISTRIBUTION		CD-178 internal & external retaining rings				111 BELL STREET W. BABYLON, NY 11704 (516) 756-0120	
<p>45278 1</p>  <p>For 1/4" Shaft With .230 Groove Dia. .025 Thick</p>	<p>45280 2</p>  <p>For 5/16" Shaft With .290 Groove Dia. .025 Thick</p>	<p>45282 3</p>  <p>For 3/8" Shaft With .352 Groove Dia. .025 Thick</p>	<p>45283 4</p>  <p>For 7/16" Shaft With .412 Groove Dia. .025 Thick</p>	<p>45285 5</p>  <p>For 1/2" Shaft With .468 Groove Dia. .035 Thick</p>	<p>45286 6</p>  <p>For 9/16" Shaft With .530 Groove Dia. .035 Thick</p>		
<p>45288 7</p>  <p>For 5/8" Shaft With .588 Groove Dia. .035 Thick</p>	<p>45289 8</p>  <p>For 11/16" Shaft With .646 Groove Dia. .042 Thick</p>	<p>45290 9</p>  <p>For 3/4" Shaft With .704 Groove Dia. .042 Thick</p>	<p>45293 10</p>  <p>For 1" Shaft With .940 Groove Dia. .042 Thick</p>	<p>45295 11</p>  <p>For 1-3/16" Shaft W/1.118 Groove Dia. .050 Thick</p>	<p>45296 12</p>  <p>For 1-1/4" Shaft W/1.176 Groove Dia. .050 Thick</p>		
<p>45252 13</p>  <p>For 7/16" Hsg. With .461 Groove Dia. .025 Thick</p>	<p>45254 14</p>  <p>For 1/2" Hsg. With .530 Groove Dia. .035 Thick</p>	<p>45255 15</p>  <p>For 9/16" Hsg. With .596 Groove Dia. .035 Thick</p>	<p>45256 16</p>  <p>For 5/8" Hsg. With .665 Groove Dia. .035 Thick</p>	<p>45257 17</p>  <p>For 11/16" Hsg. With .732 Groove Dia. .035 Thick</p>	<p>45298 18</p>  <p>For 1-7/16" Shaft W/1.350 Groove Dia. .060 Thick</p>		
<p>45258 19</p>  <p>For 3/4" Hsg. W/.796 Groove Dia. .035 Thick</p>	<p>45260* 20</p>  <p>For 7/8" Hsg. W/.931 Groove Dia. .042 Thick</p>	<p>45261 21</p>  <p>For 15/16" Hsg. W/1.000 Groove Dia. .042 Thick</p>	<p>45262 22</p>  <p>For 1" Hsg. W/1.066 Groove Dia. .042 Thick</p>	<p>45265 23</p>  <p>For 1-1/4" Hsg. With 1.330 Groove Dia. .050 Thick</p>	<p>45300 24</p>  <p>For 1-1/2" Shaft W/1.406 Groove Dia. .050 Thick</p>		

CD - 179 Internal Retaining Rings

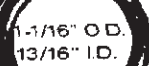
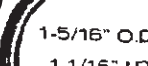





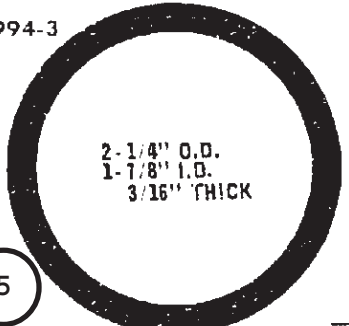
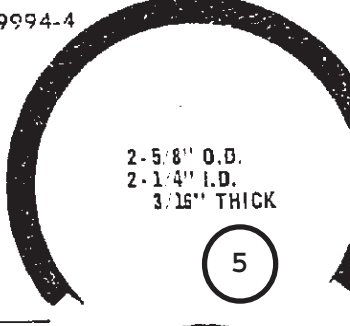
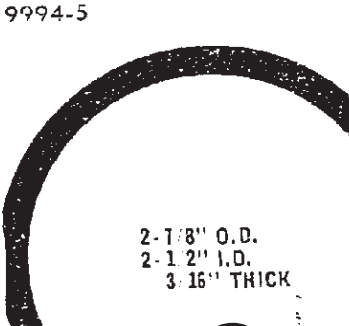

99902 24 Space Tray

CHOICE DISTRIBUTION		CD-179 Internal Retaining Rings				111 BELL STREET W. BABYLON, NY 11704 (631) 756-0120	
		*(Illustration Not Actual Size)					
<p>25 45252¹</p>  <p>For 7/16" Hsg. With .461 Groove Dia. .025 Thick</p>	<p>25 45254²</p>  <p>For 1/2" Hsg. With .530 Groove Dia. .035 Thick</p>	<p>25 45255³</p>  <p>For 9/16" Hsg. With .596 Groove Dia. .035 Thick</p>	<p>25 45256⁴</p>  <p>For 5/8" Hsg. With .665 Groove Dia. .035 Thick</p>	<p>25 45257⁵</p>  <p>For 11/16" Hsg. With .732 Groove Dia. .035 Thick</p>	<p>45258⁶</p>  <p>10 For 3/4" Hsg. With .796 Groove Dia. .035 Thick</p>		
<p>25 45258-1⁷</p>  <p>For 13/16" Hsg. W/.862 Groove Dia. .042 Thick</p>	<p>10 45260⁸</p>  <p>For 7/8" Hsg. W/.931 Groove Dia. .042 Thick</p>	<p>10 45261⁹</p>  <p>For 15/16" Hsg. W/1.000 Groove Dia. .042 Thick</p>	<p>10 45262¹⁰</p>  <p>For 1" Hsg. W/1.066 Groove Dia. .042 Thick</p>	<p>10 45262-1¹¹</p>  <p>For 1-1/16" Hsg. W/1.130 Groove Dia. .050 Thick</p>	<p>45262-2¹²</p>  <p>10 For 1-1/8" Hsg. W/1.197 Groove Dia. .050 Thick</p>		
<p>10 45265¹³</p>  <p>For 1-1/4" Hsg. W/1.330 Groove Dia. .050 Thick</p>	<p>10 45266¹⁴</p>  <p>For 1-5/16" Hsg. W/1.396 Groove Dia. .050 Thick</p>	<p>10 45267¹⁵</p>  <p>For 1-3/8" Hsg. W/1.461 Groove Dia. .050 Thick</p>	<p>10 45268*¹⁶</p>  <p>For 1-7/16" Hsg. W/1.528 Groove Dia. .050 Thick</p>	<p>10 45269*¹⁷</p>  <p>For 1-1/2" Hsg. W/1.594 Groove Dia. .050 Thick</p>	<p>45270*¹⁸</p>  <p>10 For 1-9/16" Hsg. W/1.658 Groove Dia. .062 Thick</p>		
<p>10 45271*¹⁹</p>  <p>For 1-5/8" Hsg. W/1.725 Groove Dia. .062 Thick</p>	<p>20²⁰</p>	<p>10 45272*²¹</p>  <p>For 1-3/4" Hsg. W/1.858 Groove Dia. .062 Thick</p>	<p>22²²</p>	<p>10 45273*²³</p>  <p>For 1-7/8" Hsg. W/1.989 Groove Dia. .062 Thick</p>	<p>10 45274*²⁴</p>  <p>For 2" Hsg. W/2.122 Groove Dia. .062 Thick</p>		

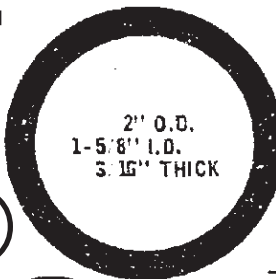
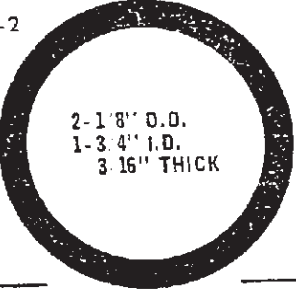
CD - 180 O Rings
99902 24 Space Tray

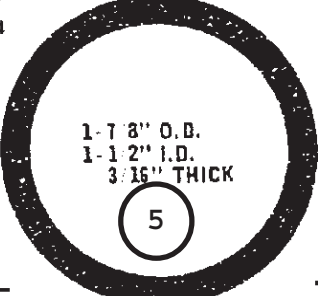
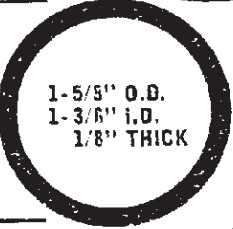
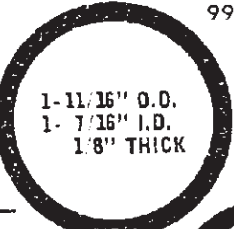











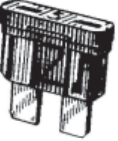

CHOICE DISTRIBUTION		CD-180 "O" RINGS				111 BELL STREET W. BABYLON, NY 11704 (516) 756-0120	
<p>9971 ¹</p>  <p>25</p> <p>1/4" O.D. 1/8" I.D. 1/16" Thick</p>	<p>9975 ²</p>  <p>25</p> <p>3/8" O.D. 1/4" I.D. 1/16" Thick</p>	<p>9977-1 ³</p>  <p>25</p> <p>11/16" O.D. 9/16" I.D. 1/16" Thick</p>	<p>9980 ⁴</p>  <p>25</p> <p>11/16" O.D. 1/2" I.D. 3/32" Thick</p>	<p>5</p> <p>9984 ⁵</p>  <p>15/16" O.D. 3/4" I.D. 3/32" Thick</p>	<p>5</p> <p>9988 ⁶</p>  <p>1-3/16" O.D. 15/16" I.D. 1/8" Thick</p>		
<p>9972 ⁷</p>  <p>25</p> <p>9/32" O.D. 5/32" I.D. 1/16" Thick</p>	<p>9976 ⁸</p>  <p>25</p> <p>7/16" O.D. 5/16" I.D. 1/16" Thick</p>	<p>9977-2 ⁹</p>  <p>25</p> <p>13/16" O.D. 11/16" I.D. 1/16" Thick</p>	<p>5</p> <p>9981 ¹⁰</p>  <p>3/4" O.D. 9/16" I.D. 3/32" Thick</p>	<p>5</p> <p>9985 ¹¹</p>  <p>1" O.D. 3/4" I.D. 1/8" Thick</p>	<p>5</p> <p>9989 ¹²</p>  <p>1-1/4" O.D. 1" I.D. 1/8" Thick</p>		
<p>9973 ¹³</p>  <p>25</p> <p>5/16" O.D. 3/16" I.D. 1/16" Thick</p>	<p>9977 ¹⁴</p>  <p>25</p> <p>1/2" O.D. 3/8" I.D. 1/16" Thick</p>	<p>9978 ¹⁵</p>  <p>25</p> <p>9/16" O.D. 3/8" I.D. 3/32" Thick</p>	<p>5</p> <p>9983 ¹⁶</p>  <p>7/8" O.D. 11/16" I.D. 3/32" Thick</p>	<p>5</p> <p>9986 ¹⁷</p>  <p>1-1/16" O.D. 13/16" I.D. 1/8" Thick</p>	<p>5</p> <p>9990 ¹⁸</p>  <p>1-5/16" O.D. 1-1/16" I.D. 1/8" Thick</p>		
<p>9974 ¹⁹</p>  <p>25</p> <p>11/32" O.D. 7/32" I.D. 1/16" Thick</p>	<p>9977-X ²⁰</p>  <p>25</p> <p>9/16" O.D. 7/16" I.D. 1/16" Thick</p>	<p>9979 ²¹</p>  <p>25</p> <p>5/8" O.D. 7/16" I.D. 3/32" Thick</p>	<p>5</p> <p>9982 ²²</p>  <p>13/16" O.D. 5/8" I.D. 3/32" Thick</p>	<p>5</p> <p>9987 ²³</p>  <p>1-1/8" O.D. 7/8" I.D. 1/8" Thick</p>	<p>24</p>		

CD - 182 Rubber O Rings
 99905 Adjustable Space Tray

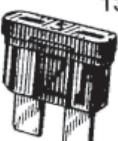
CHOICE DISTRIBUTION		CD - 182 rubber "o" rings		111 BELL STREET W. BABYLON, NY 11704 (516) 756-0120	
<p>9994-3</p>  <p>2-1/4" O.D. 1-7/8" I.D. 3/16" THICK</p> <p>5</p>	<p>9994-4</p>  <p>2-5/8" O.D. 2-1/4" I.D. 3/16" THICK</p> <p>5</p>	<p>9994-5</p>  <p>2-7/8" O.D. 2-1/2" I.D. 3/16" THICK</p> <p>5</p>	<p>9994-6</p>  <p>3-1/2" O.D. 3-1/8" I.D. 3/16" THICK</p> <p>5</p>		
<p>9994-1</p>  <p>2" O.D. 1-5/8" I.D. 3/16" THICK</p> <p>5</p>	<p>9994-2</p>  <p>2-1/8" O.D. 1-3/4" I.D. 3/16" THICK</p> <p>5</p>	<p>9991-6</p>  <p>1-3/4" O.D. 1-1/2" I.D. 1/8" THICK</p> <p>5</p>	<p>9994</p>  <p>1-7/8" O.D. 1-1/2" I.D. 3/16" THICK</p> <p>5</p>		
<p>9991-4</p>  <p>1-5/8" O.D. 1-3/8" I.D. 1/8" THICK</p> <p>5</p>	<p>9991-5</p>  <p>1-11/16" O.D. 1-7/16" I.D. 1/8" THICK</p> <p>5</p>	<p>9991-1</p>  <p>1-7/16" O.D. 1-3/16" I.D. 1/8" THICK</p> <p>5</p>	<p>9991</p>  <p>1-3/8" O.D. 1-1/8" I.D. 1/8" THICK</p> <p>5</p>		
<p>9991-3</p>  <p>1-9/16" O.D. 1-5/16" I.D. 1/8" THICK</p> <p>5</p>	<p>9991-2</p>  <p>1-1/2" O.D. 1-1/4" I.D. 1/8" THICK</p> <p>5</p>				



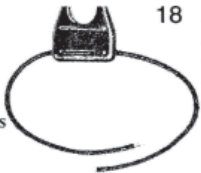









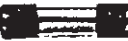





CD - 183 MAX & ATM Type Fuses
 99937 20 Space Tray
 99936 Outside Shell

CHOICE
CHOICE
 DISTRIBUTION INC.
www.choice-distribution.com

CHOICE DISTRIBUTION		CD-183 MAX & ATM TYPE FUSES		111 BELL STREET W. BABYLON, NY 11704 (516) 756-0120	
2	7533 MAX-20 20 AMP Yellow	1		2	
5	7539-3 ATM-3 3 AMP Violet	3		4	5 7539-15 ATM-15 15 AMP Lt. Blue 
2	7534 MAX-30 30 AMP Green	5		6	
5	7539-4 ATM-4 4 AMP Pink	7		8	5 7539-20 ATM-20 20 AMP Yellow 
2	7535 MAX-40 40 AMP Orange	9		10	
5	7539-5 ATM-5 5 AMP Tan	11		12	5 7539-25 ATM-25 25 AMP White 
2	7536 MAX-50 50 AMP Red	13		14	
5	7539-7 ATM-7-1/2 7-1/2 AMP Brown	15		16	5 7539-30 ATM-30 30 AMP Lt. Green 
2	7537 MAX-60 60 AMP Blue	17		18	2 7540 In Line Fuse Holder For ATO & ATC Fuses 12 Gauge Wires 
5	7539-10 ATM-10 10 AMP Red	19		20	

CD - 184 Automotive Fuses
 99937 20 Space Tray
 99936 Outside Shell













CHOICE
CHOICE
 DISTRIBUTION INC.
www.choice-distribution.com









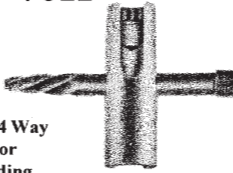











CHOICE DISTRIBUTION		CD-184 AUTOMOTIVE FUSES		111 BELL STREET W. BABYLON, NY 11704 (516) 756-0120			
7569-A  5 ATO-3 3 AMP	1	7559-A  5 ATO-15 15 AMP	2	7552  10 SFE-9 9 AMP (7/8" LENGTH)	3	7559  10 AGC-15 15 AMP (1 1/4" LENGTH)	4
7573-A  5 ATO-4 4 AMP	5	7554-A  5 ATO-20 20 AMP	6	7553  10 SFE-14 14 AMP (1 1/16" LENGTH)	7	7567  10 AGC-25 25 AMP (1 1/4" LENGTH)	8
7574-A  5 ATO-5 5 AMP	9	7567-A  5 ATO-25 25 AMP	10	7554  10 SFE-20 20 AMP (1 1/4" LENGTH)	11	7560  10 AGC-30 30 AMP (1 1/4" LENGTH)	12
7561-A  5 ATO-7 1/2 7 1/2 AMP	13	7560-A  5 ATO-30 30 AMP	14	7555  10 SFE-30 30 AMP (1 7/16" LENGTH)	15	7562  10 AGA-30 30 AMP (5/8" LENGTH)	16
7558-A  5 ATO-10 10 AMP	17		18	7558  10 AGC-10 10 AMP (1 1/4" LENGTH)	19	7563  10 AGW-15 15 AMP (7/8" LENGTH)	20



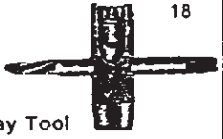







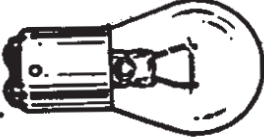

CD - 185 ATC & ATM Type Fuses
 99937 20 Space Tray
 99936 Outside Shell

CHOICE
CHOICE
 DISTRIBUTION INC.
www.choice-distribution.com

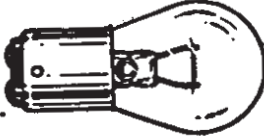
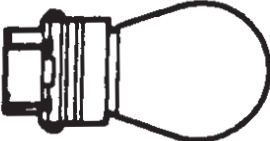

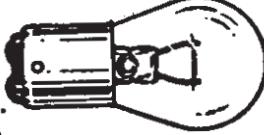
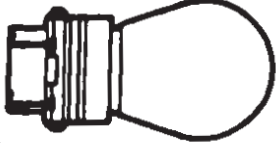















CHOICE DISTRIBUTION		CD-185 ATC & ATM TYPE FUSES		111 BELL STREET W. BABYLON, NY 11704 (516) 756-0120	
5	7569-A ATC-3 3 AMP Violet	1	5	7559-A ATC-15 15 AMP Lt. Blue	2
3	7539-3 ATM-3 3 AMP Violet	3	3	7539-15 ATM-15 15 AMP Lt. Blue	4
5	7573-A ATC-4 4 AMP Pink	5	5	7554-A ATC-20 20 AMP Yellow	6
3	7539-4 ATM-4 4 AMP Pink	7	3	7539-20 ATM-20 20 AMP Yellow	8
5	7574-A ATC-5 5 AMP Tan	9	5	7567-A ATC-25 25 AMP White	10
3	7539-5 ATM-5 5 AMP Tan	11	3	7539-25 ATM-25 25 AMP White	12
5	7561-A ATC-7-1/2 7-1/2 AMP Brown	13	5	7560-A ATC-30 30 AMP Lt. Green	14
3	7539-7 ATM-7-1/2 7-1/2 AMP Brown	15	3	7539-30 ATM-30 30 AMP Lt. Green	16
5	7558-A ATC-10 10 AMP Red	17	2	7540 In Line Fuse Holder For ATO & ATC Fuse 16 Gauge Wires	18
3	7539-10 ATM-10 10 AMP Red	19			20

CHOICE DISTRIBUTION		CD-186 Grease Fittings				111 BELL STREET W. BABYLON, NY 11704 (631) 756-0120	
<p>7596 ¹</p> <p>25 </p> <p>3/16" Drive Base Straight</p>	<p>2</p>	<p>7589 ³</p> <p>25 </p> <p>1/4" Drive Base Straight</p>	<p>4</p>	<p>7579-1 ⁵</p> <p>10 </p> <p>5/16" Drive Type Straight</p>	<p>7581 ⁶</p> <p>10 </p> <p>1/4" - 28 - Straight</p>		
<p>7</p>	<p>7597 ⁸</p> <p>25 </p> <p>Self Threading 1/4" - 28 - Straight</p>	<p>9</p>	<p>7578 ¹⁰</p> <p>25 </p> <p>1/4" - 28 - Straight</p>	<p>11</p>	<p>7610 ¹²</p> <p>1 </p> <p>Small 4 Way Tool For Threading Inserting & extracting Fittings</p>		
<p>7600 ¹³</p> <p>25 </p> <p>1/4" - 28 - Straight</p>	<p>14</p>	<p>7599 ¹⁵</p> <p>10 </p> <p>Self Threading 1/4" - 28 - 90° Elbow</p>	<p>16</p>	<p>7582 ¹⁷</p> <p>10 </p> <p>1/4" - 28 - 90° Elbow</p>	<p>18</p>		
<p>19</p>	<p>7580 ²⁰</p> <p>10 </p> <p>1/4" - 28 - 45° Elbow</p>	<p>21</p>	<p>7577 ²²</p> <p>25 </p> <p>1/8"P.T. Straight</p>	<p>23</p>	<p>7611 ²⁴</p> <p>1 </p> <p>Large 4 Way Tool For Threading Inserting & extracting Fittings</p>		

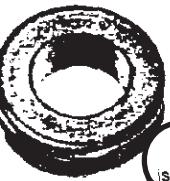







CHOICE DISTRIBUTION		CD-188 Grease Fittings				111 BELL STREET W. BABYLON, NY 11704 (516) 756-0120	
7575-1 1  5 1/8" P.T. — 45° Elbow	7576 2  5 1/8" P.T. — 65° Elbow	7585 3  5 Self Threading 65° Elbow (To Replace 1/8" P.T.)	7588 4  5 1/8" P.T. — 90° Elbow	5	7611 6  1 Large 4 Way Tool For Threading Inserting & Extracting Fittings		
7579-1 7  10 5/16" Drive Type Straight	7603 8  10 5/16"-24 — Straight	7577 9  5 1/8" P.T. — Straight	7583 10  5 Self Threading — Straight (To Replace 1/8" P.T.)	11	7595 12  5 1/8" P.T. — 1 3/4" Long Straight		
7582 13  10 1/4"-28 — 90° Elbow	7599 14  10 Self Threading 1/4"-28 — 90° Elbow	7580 15  10 1/4"-28 — 45° Elbow	7586 16  10 1/4" P.T. — Straight	7587 17  5 1/4" P.T. — 67 1/2° Elbow	7610 18  1 Small 4 Way Tool For Threading, Inserting & Extracting Fittings		
7596 19  10 3/16" Drive Base Straight	7589 20  10 1/4" Drive Base Straight	7578 21  10 1/4"-28 — Straight	7597 22  10 Self Threading 1/4"-28 — Straight	7600 23  10 1/4"-28 — Straight	7581 24  10 1/4"-28 — Straight		

CHOICE DISTRIBUTION	CD-189 MINIATURE LAMPS			111 BELL STREET W. BABYLON, NY 11704 (516) 756-0120
 5 7438 GE #1891	 5 7488 GE #194	 5 7469-H GE #1157	 5 7464 GE #89	
 5 7486 GE #1816	 5 7488-A GE #194-A	 5 7439 GE #2057	 5 7446 GE #3157	
 5 7461 GE #57	 5 7462 GE #67	 5 7440 GE #2057NA	 5 7447 GE #3157NA	
 5 7461-H GE #1895	 5 7470-H GE #1156			
 5 7489 GE #1893				

CD - 190 Rubber Grommets
99902 24 Space Tray

CHOICE DISTRIBUTION		CD-190 Rubber grommets				215K CENTRAL AVENUE FARMINGDALE, NY 11735 (516) 756-0120	
1	2	<p>9684 3</p>  <p>5/8" O.D. x 5/16" I.D. 1/4" Thick Groove 13/32" Dia. 1/16" Width List</p>	<p>9684 4</p>  <p>5/8" O.D. x 5/16" I.D. 1/4" Thick Groove 13/32" Dia. 1/16" Width List</p>	<p>9688 5</p>  <p>7/8" O.D. x 1/2" I.D. 1/4" Thick Groove 21/32" Dia. 1/16" Width List</p>	<p>9689 6</p>  <p>1-3/32" O.D. 5/8" I.D. 5/16" Thick Groove 27/32" Dia. 1/16" Width List</p>		
<p>9681 7</p>  <p>5/16" O.D. x 1/8" I.D. 3/16" Thick Groove 7/32" Dia. 1/16" Width List</p>	<p>9681 8</p>  <p>5/16" O.D. x 1/8" I.D. 3/16" Thick Groove 7/32" Dia. 1/16" Width List</p>	9	10	<p>9688 11</p>  <p>7/8" O.D. x 1/2" I.D. 1/4" Thick Groove 21/32" Dia. 1/16" Width List</p>	<p>9689 12</p>  <p>1-3/32" O.D. 5/8" I.D. 5/16" Thick Groove 27/32" Dia. 1/16" Width List</p>		
<p>9682 13</p>  <p>7/16" O.D. x 3/16" I.D. 1/4" Thick Groove 9/32" Dia. 1/16" Width List</p>	<p>9682 14</p>  <p>7/16" O.D. x 3/16" I.D. 1/4" Thick Groove 9/32" Dia. 1/16" Width List</p>	<p>9686 15</p>  <p>5/8" O.D. x 3/8" I.D. 1/4" Thick Groove 15/32" Dia. 1/16" Width List</p>	<p>9686 16</p>  <p>5/8" O.D. x 3/8" I.D. 1/4" Thick Groove 15/32" Dia. 1/16" Width List</p>	<p>9691* 17</p>  <p>1-3/16" O.D. x 3/4" I.D. 3/8" Thick Groove 1" Dia. 1/8" Width List</p>	<p>9690 18</p>  <p>1-1/8" O.D. 5/8" I.D. 5/8" Thick Groove 29/32" Dia. 5/16" Width List</p>		
<p>9683 19</p>  <p>9/16" O.D. x 1/4" I.D. 1/4" Thick Groove 11/32" Dia. 1/16" Width List</p>	<p>9683 20</p>  <p>9/16" O.D. x 1/4" I.D. 1/4" Thick Groove 11/32" Dia. 1/16" Width List</p>	<p>9687 21</p>  <p>11/16" O.D. x 7/16" I.D. 3/16" Thick Groove 17/32" Dia. 1/32" Width List</p>	<p>9687 22</p>  <p>11/16" O.D. x 7/16" I.D. 3/16" Thick Groove 17/32" Dia. 1/32" Width List</p>	<p>9691* 23</p>  <p>1-3/16" O.D. x 3/4" I.D. 3/8" Thick Groove 1" Dia. 1/8" Width List</p>	<p>9690 24</p>  <p>1-1/8" O.D. 5/8" I.D. 5/8" Thick Groove 29/32" Dia. 5/16" Width List</p>		

CD - 191 Monobolts & Rivets
99905 Adjustable Space Tray
50 Pieces Each

CHOICE DISTRIBUTION	CD-191 Monobolts & Rivets			111 BELL STREET W. BABYLON, NY 11704 (631) 756-0120
<p data-bbox="283 544 451 609">Steel Monobolt 3/16 Short</p>  <p data-bbox="304 779 409 820">36105</p>	<p data-bbox="724 544 892 609">Steel Monobolt 1/4 Short</p>  <p data-bbox="756 779 861 820">36107</p>	<p data-bbox="1186 544 1396 609">Aluminum Monobolt 1/4 Short</p>  <p data-bbox="1239 779 1344 820">36109</p>	<p data-bbox="1533 519 1911 641">Aluminum & Steel Automotive Window & Door Rivets .250 Diameter .032-.140 Grip Range</p>  <p data-bbox="1669 779 1774 820">36195</p>	
<p data-bbox="283 1023 451 1079">Steel Monobolt 3/16 Long</p>  <p data-bbox="304 1242 409 1282">36106</p>	<p data-bbox="724 1023 892 1079">Steel Monobolt 1/4 Long</p>  <p data-bbox="756 1242 861 1282">36108</p>	<p data-bbox="1186 1023 1396 1079">Aluminum Monobolt 1/4 Long</p>  <p data-bbox="1239 1242 1344 1282">36110</p>	<p data-bbox="1533 998 1911 1112">Aluminum & Steel Automotive Window & Door Rivets .250 Diameter .520-.620 Grip Range</p>  <p data-bbox="1669 1242 1774 1282">36196</p>	





CD - 192 Blind Rivets
 99937 20 Space Tray
 99936 Outside Shell

CHOICE
CHOICE
 DISTRIBUTION INC.
www.choice-distribution.com



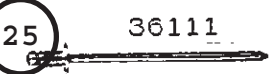
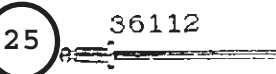
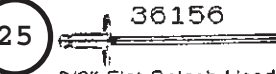
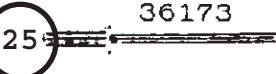
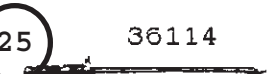
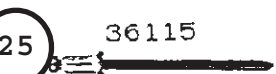
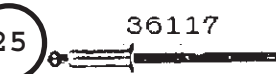
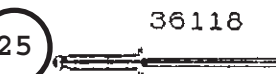
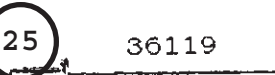
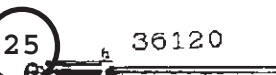
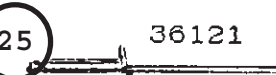
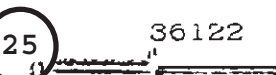
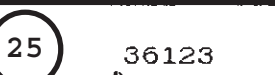

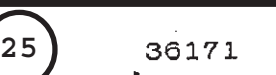

CHOICE
DISTRIBUTION















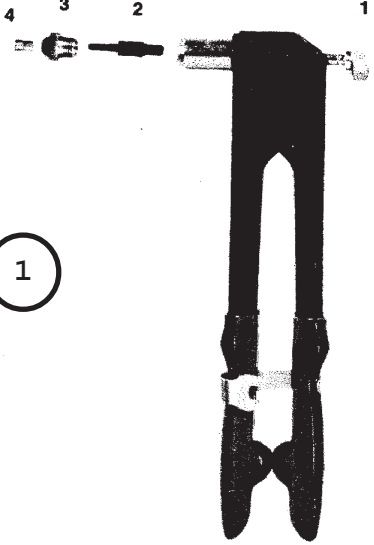





CD - 192 BLIND RIVETS

111 BELL STREET
 W. BABYLON, NY 11704
 (516) 756-0120

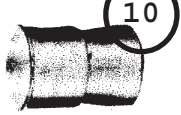
<p>25 36111 ¹</p>  <p>Button Head - 1/8" Dia. Steel Rivet & Mandrel Grip Range, .020 - .062</p>	<p>25 36112 ²</p>  <p>Button Head - 1/8" Dia. Steel Rivet & Mandrel Grip Range, .063 - .125</p>	<p>25 36156 ³</p>  <p>3/8" Flat Splash Head 1/8" Dia. Steel Rivet & Mandrel Grip Range, .063 - .125</p>	<p>25 36173 ⁴</p>  <p>Button Head - 1/8" Dia. Aluminum Rivet & Mandrel Grip Range, .188 - .250</p>
<p>25 36114 ⁵</p>  <p>Button Head - 1/8" Dia. Steel Rivet & Mandrel Grip Range, .188 - .250</p>	<p>25 36115 ⁶</p>  <p>Countersunk Head - 1/8" Dia. Steel Rivet & Mandrel Grip Range, .063 - .125</p>	<p>25 36117 ⁷</p>  <p>Countersunk Head - 1/8" Dia. Steel Rivet & Mandrel Grip Range, .126 - .250</p>	<p>25 36118 ⁸</p>  <p>Button Head - 1/8" Dia. Steel Rivet & Mandrel Grip Range, .313 - .375</p>
<p>25 36119 ⁹</p>  <p>Button Head - 3/16" Dia. Aluminum Rivet & Mandrel Grip Range, .025 - .125</p>	<p>25 36120 ¹⁰</p>  <p>Button Head - 3/16" Dia. Aluminum Rivet & Mandrel Grip Range, .126 - .250</p>	<p>25 36121 ¹¹</p>  <p>Button Head - 3/16" Dia. Aluminum Rivet & Mandrel Grip Range, .251 - .375</p>	<p>25 36122 ¹²</p>  <p>Button Head - 3/16" Dia. Aluminum Rivet & Mandrel Grip Range, .376 - .500</p>
<p>25 36123 ¹³</p>  <p>Button Head - 3/16" Dia. Aluminum Rivet & Mandrel Grip Range, .501 - .625</p>	<p>25 36142 ¹⁴</p>  <p>5/8" Flat Splash Head 3/16" Dia. Aluminum Rivet & Steel Mandrel Grip Range, .251 - .375</p>	<p>25 36171 ¹⁵</p>  <p>Button Head - 1/8" Dia. Aluminum Rivet & Mandrel Grip Range, .063 - .125</p>	<p>25 36113 ¹⁶</p>  <p>Button Head - 1/8" Dia. Steel Rivet & Mandrel Grip Range, .126 - .187</p>
<p>¹⁷</p>	<p>¹⁸</p>	<p>¹⁹</p>	<p>²⁰</p>

CD - 193 Zinc Nail-In Anchors
99905 Adjustable Space Tray

CHOICE DISTRIBUTION		CD-193 Zinc Nail-in Anchors		111 BELL STREET W. BABYLON, NY 11704 (516) 756-0120	
<p>(25) 36000</p>  <p>3-16" x 7/8"</p>	<p>(25) 36003</p>  <p>1/4" x 1"</p>	<p>(25) 36005</p>  <p>1/4" x 1-1/2"</p>	<p>(25) 36007</p>  <p>1/4" x 2"</p>		
<p>(25) 36002</p>  <p>1/4" x 3/4"</p>	<p>(25) 36004</p>  <p>1/4" x 1- 1/4"</p>				

CHOICE DISTRIBUTION		CD-194 NUTSERTS USS & SAE				111 BELL STREET W. BABYLON, NY 11704 (631) 756-0120	
1	15101 ²  No. 6-32 Thd. Use Drill Size 7/32"	15102 ³  No. 8-32 Thd. Use Drill Size 1/4"	15103 ⁴  No. 10-24 Thd. Use Drill Size 9/32"	15104 ⁵  No. 10-32 Thd. Use Drill Size 9/32"	15130 ⁶ 		
7	15121 ⁸  Conversion Kit For No. 6-32	15122 ⁹  Conversion Kit For No. 8-32	15123 ¹⁰  Conversion Kit For No. 10-24	15124 ¹¹  Conversion Kit For No. 10-32	1 		
15105 ¹²  1/4"-20 Thd. Use Drill Size 3/8"	15106 ¹³  1/4"-28 Thd. Use Drill Size 3/8"	15107 ¹⁴  5/16"-18 Thd. Use Drill Size 1/2"	15108 ¹⁵  5/16"-24 Thd. Use Drill Size 1/2"	15109 ¹⁶  3/8"-16 Thd. Use Drill Size 9/16"	ASSEMBLY INSTRUCTIONS 1. Select the correct nose bushing (3) and mandrel (2) for the nutsert you want to place. 2. With tool in the full open position screw in the mandrel (Note: Left Hand Thread). 3. By hand, screw the bushing into the tool nose (Note: Also Left Hand Thread). 4. Screw the nutsert (4) onto the protruding mandrel until it is flush against the nose bushing. 5. Place nutsert into a prepared hole and squeeze the handles. 6. A nutsert is fully placed when the tool handles can no longer be depressed under normal hand pressure. At this point, Release the Handles Immediately. Do Not Force the Tool Handles into a Fully Closed Position. 7. Disengage the mandrel by rotating the mandrel puller knob (1) in a counter-clockwise direction.		
15125 ¹⁷  Conversion Kit For 1/4"-20	15126 ¹⁸  Conversion Kit For 1/4"-28	15127 ¹⁹  Conversion Kit For 5/16"-18	15128 ²⁰  Conversion Kit For 5/16"-24	15129 ²¹  Conversion Kit For 3/8"-16			

CD - 195 Color Cable Ties
 99938 Adjustable Horizontal Tray
 50 Pieces Each

**CHOICE
 DISTRIBUTION**

CD-195 COLOR CABLE TIES

111 BELL STREET
 W. BABYLON, NY 11704
 (631) 756-0120



6930 BROWN

Length 7.5" Width - .178 Min. Tensile Strength 50 LBS. Wirebundle Range 1/16" TO 1 7/8"



6934 GREEN

Length 7.5" Width - .178 Min. Tensile Strength 50 LBS. Wirebundle Range 1/16" TO 1 7/8"



6931 RED

Length 7.5" Width - .178 Min. Tensile Strength 50 LBS. Wirebundle Range 1/16" TO 1 7/8"



6935 BLUE

Length 7.5" Width - .178 Min. Tensile Strength 50 LBS. Wirebundle Range 1/16" TO 1 7/8"



6932 ORANGE

Length 7.5" Width - .178 Min. Tensile Strength 50 LBS. Wirebundle Range 1/16" TO 1 7/8"



6936 PURPLE

Length 7.5" Width - .178 Min. Tensile Strength 50 LBS. Wirebundle Range 1/16" TO 1 7/8"



6933 YELLOW

Length 7.5" Width - .178 Min. Tensile Strength 50 LBS. Wirebundle Range 1/16" TO 1 7/8"



6937 GRAY

Length 7.5" Width - .178 Min. Tensile Strength 50 LBS. Wirebundle Range 1/16" TO 1 7/8"



6904 WHITE

Length 7.5" Width - .178 Min. Tensile Strength 50 LBS. Wirebundle Range 1/16" TO 1 7/8"





6924 BLACK

Length 7.5" Width - .178 Min. Tensile Strength 50 LBS. Wirebundle Range 1/16" TO 1 7/8"



6899 CABLE TIE MOUNTS

CD - 196 Ty-Rap
 99905 Adjustable Space Tray

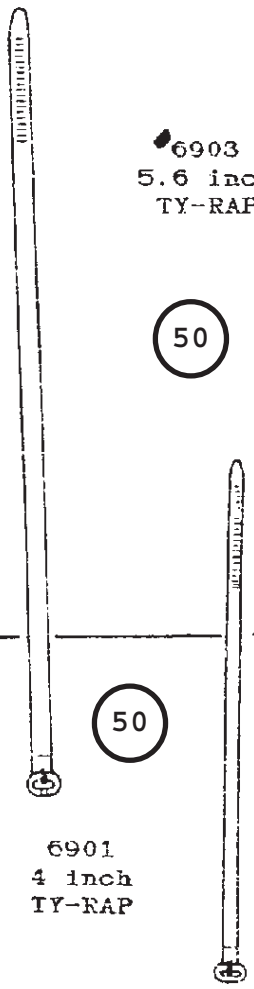
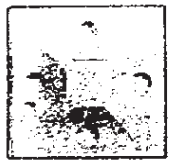
CHOICE DISTRIBUTION	CD-196 Ty-Rap		111 BELL STREET W. BABYLON, NY 11704 (516) 756-0120	
 <p data-bbox="325 787 588 893">6914 7.5 inch TY-RAP with mounting hole</p> <p data-bbox="441 1153 525 1226">25</p>	 <p data-bbox="819 787 945 893">6924 7 inch TY-RAP BLACK</p> <p data-bbox="829 998 913 1071">25</p>	 <p data-bbox="1281 779 1407 868">6904 7 inch TY-RAP</p> <p data-bbox="1270 1039 1354 1112">50</p>	 <p data-bbox="1690 568 1848 665">6903 5.6 inch TY-RAP</p> <p data-bbox="1711 738 1795 812">50</p> <p data-bbox="1585 1274 1711 1364">6901 4 inch TY-RAP</p> <p data-bbox="1648 1120 1732 1193">50</p>	
	 <p data-bbox="903 1258 997 1291">6900</p> <p data-bbox="682 1388 871 1429">TWO-WAY ADHESIVE MOUNTING BASE</p> <p data-bbox="934 1339 1018 1412">10</p>			

CD - 197 Ty-Rap
99906 Long Space Tray

CHOICE
DISTRIBUTION

CD-197

Ty-Rap

215K CENTRAL AVENUE
FARMINGDALE, NY 11735
(516) 756-0120

25

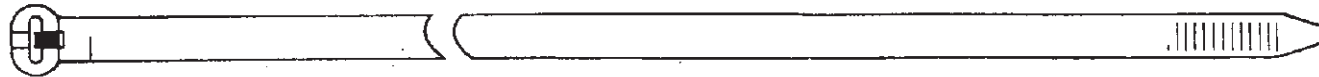

6907 14,25 inch TY-RAP

25

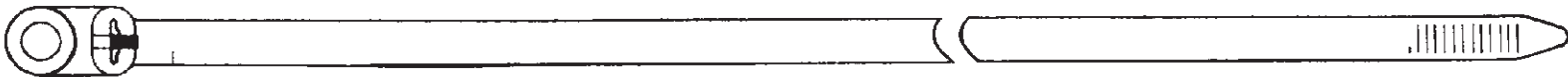

6916 14.85 inch TY-RAP with mounting hole

25



6906 14.1 inch TY-RAP

25

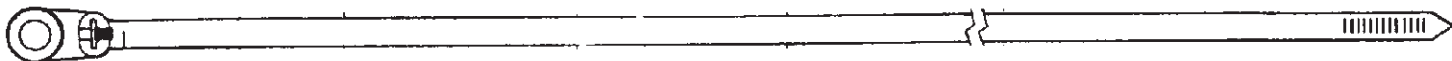

6915 14.5 inch TY-RAP with mounting hole

25

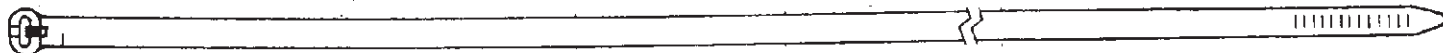

6905 11.1 inch TY-RAP

CD - 198 Universal Wire & Cable Clamps
99905 Adjustable Space Tray

CHOICE
DISTRIBUTION

CD-198 Universal wire & cable clamps

111 BELL STREET
W. BABYLON, NY 11704
(516) 754-0120

10 1004



Clip, Wire Loom
For 1/2" Dia. Wire
List

10 1005



Clip, Wire Loom
For 5/8" Dia. Wire
List

10 1006



Clip, Wire Loom
For 3/4" Dia. Wire

10 1007



Clip, Wire Loom
For 1" Dia. Wire

10 1001



Clip, Wire Loom
For 1/4" Dia. Wire

10 1003



Clip, Wire Loom
For 3/8" Dia. Wire

25 1030



Clip, Wire Loom
For 3/16" Dia. Wire

25 1031



Clip, Wire Loom
For 1/4" Dia. Wire

25 1032



Clip, Wire Loom
For 5/16" Dia. Wire

25 1033















Clip, Wire Loom
For 3/8" Dia. Wire

CD - 199 Stainless Steel Rivets
 99937 20 Space Tray
 99936 Outside Shell

CHOICE
DISTRIBUTION

CD-199 Stainless Steel Rivets

111 BELL STREET
 W. BABYLON, NY 11704
 (631) 756-0120

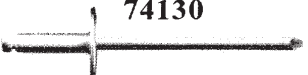
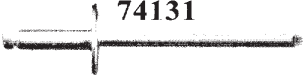
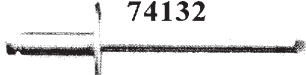
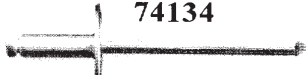
<p>74101 1</p>  <p>25 Buttonhead - 1/8" Dia. Stainless Steel Rivet & Mandrel Grip Range: .126-.250</p>	<p>74102 2</p>  <p>25 Buttonhead - 1/8" Dia. Stainless Steel Rivet & Mandrel Grip Range: .126-.187</p>	<p>74103 3</p>  <p>25 Buttonhead - 1/8" Dia. Stainless Steel Rivet & Mandrel Grip Range: .188-.250</p>	<p>74105 4</p>  <p>25 Buttonhead - 1/8" Dia. Stainless Steel Rivet & Mandrel Grip Range: .313-.375</p>
<p>74107 5</p>  <p>25 Buttonhead - 5/32" Dia. Stainless Steel Rivet & Mandrel Grip Range: .020-.125</p>	<p>74109 6</p>  <p>25 Buttonhead - 5/32" Dia. Stainless Steel Rivet & Mandrel Grip Range: .126-.250</p>	<p>74110 7</p>  <p>25 Buttonhead - 5/32" Dia. Stainless Steel Rivet & Mandrel Grip Range: .251-.375</p>	<p>74112 8</p>  <p>25 Buttonhead - 3/16" Dia. Stainless Steel Rivet & Mandrel Grip Range: .020-.125</p>
<p>74113 9</p>  <p>25 Buttonhead - 3/16" Dia. Stainless Steel Rivet & Mandrel Grip Range: .126-.250</p>	<p>74114 10</p>  <p>25 Buttonhead - 3/16" Dia. Stainless Steel Rivet & Mandrel Grip Range: .251-.375</p>	<p>74115 11</p>  <p>25 Buttonhead - 3/16" Dia. Stainless Steel Rivet & Mandrel Grip Range: .376-.500</p>	<p>74119 12</p>  <p>25 Buttonhead - 1/4" Dia. Stainless Steel Rivet & Mandrel Grip Range: .062-.250</p>
<p>74130 13</p>  <p>25 Large Flange Head - 1/8" Dia. Stainless Steel Rivet Coated Steel Mandrel Grip Range: .032-.125</p>	<p>74131 14</p>  <p>25 Large Flange Head - 1/8" Dia. Stainless Steel Rivet Coated Steel Mandrel Grip Range: .126-.187</p>	<p>74132 15</p>  <p>25 Large Flange Head - 3/16" Dia. Stainless Steel Rivet Coated Steel Mandrel Grip Range: .062-.250</p>	<p>74134 16</p>  <p>25 Large Flange Head - 3/16" Dia. Stainless Steel Rivet Coated Steel Mandrel Grip Range: .251-.375</p>
17	18	19	20

CD - 200 Permabond 99905 Adjustable Space Tray

**CHOICE
CHOICE**
DISTRIBUTION INC.
www.choice-distribution.com

**CHOICE
DISTRIBUTION**

CD-200

Permabond

111 BELL STREET
W. BABYLON, NY 11704
(516) 756-0120

77918

1

**ANTI-
SIEZE**



Permabond Anti-Sieze lubricating compound is designed to prevent corrosion, seizure and galling of metal parts under the most extreme conditions of heat, pressure and contamination. Permabond Anti-Sieze forms a fine, protective film that can not be burned off or completely removed by abrasion. This protective coating is resistant to fresh or salt water, even after extended exposure to the elements.

77915

1

**PIPE
SEALANT
WITH TEFLON**



Permabond Pipe Sealant LH050 seals pipe joints instantly and when cured exceeds the burst rating of the pipe. LH050 permits dis-assembly with normal tools for scheduled maintenance. It works on most metals, withstands temperatures up to 400° F and is recommended on pipe diameters up to 2".

77931

1

**BOLT and
STUDLOCKING
ADHESIVE**



Permabond Bolt and Studlocking Adhesive is a high strength adhesive for permanent assembly. It makes a lower cost Class 2 stud assembly stronger than a Class 5 stud, and it eliminates the need for doublelocking or welding. The HM12B also seals studs against corrosion and leakage.

77910

1

**910°
ADHESIVE**



Permabond 910 bonds metals, plastics and rubber. It is especially well suited for metal bonding, providing superior strength. Permabond 910 resists long term exposure to temperatures up to 190° F and short term peaks of up to 300° F. Handling strength is reached as quickly as 10-30 seconds.

1

77922

**NUTLOCKING
ADHESIVE**

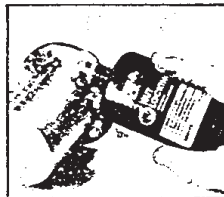

Permabond Nutlocking Adhesive is the general purpose Threadlocker and meets 80% of all nut and bolt applications. Nutlocking Adhesive is recommended for locking nuts and bolts that require dis-assembly for service or repair. The thixotropic viscosity keeps the adhesive in the threads during assembly for optimum performance. Parts may be dis-assembled with normal tools.

1

77926

**WICKING
ADHESIVE
SEALANT**



Permabond Wicking Adhesive is a low viscosity penetrating product formulated for post assembly. Parts may be adjusted or aligned after the adhesive is applied. As a preventive maintenance tool, it can lock and seal fasteners without dis-assembly. HL126 is also used to seal weld porosities.

1

77934

**HYDRAULIC
SEALANT**

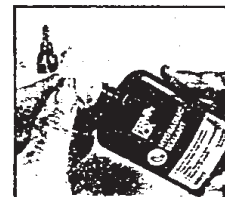

Permabond LM012 Hydraulic Sealant contains no fillers or particles to contaminate systems. LM012 seals hydraulic fluid lines against leakage from shock, vibration and pulses. Hydraulic Sealant is a liquid which cures to a solid seal, as strong as the working pressure of the line. It allows adjustment and alignment of the fittings after application.

1

30600







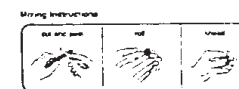









**Magic
Metal™**

A tough wear resistant bronze two part resin that cures and applies with the ease and simplicity of a one part resin. Magic Metal™ completely eliminates the fears that some users occasionally have about proper mixing with two part resins.

- will not rust
- non magnetic
- adheres to many surfaces and cures underwater
- fast - workable for 5 minutes, sets in 15 minutes
- use as both an adhesive
- no measuring or mess - out of what you need
- chemical and abrasion resistant



CD - 201 SS Security Screws
99907 21 Space Tray





CHOICE DISTRIBUTION		CD-201  STAINLESS STEEL SECURITY SCREWS				111 BELL STREET W. BABYLON, NY 11704 (631) 756-0120
<p> Button Head¹ 6-32 x 3/4 68010 T-10 Driver</p> <p>(25)</p>	<p> Button Head² 8-32 x 3/8 68020 T-15 Driver</p> <p>(25)</p>	<p> Button Head³ 8-32 x 1/2 68021 T-15 Driver</p> <p>(25)</p>	<p> Button Head⁴ 8-32 x 3/4 68023 T-15 Driver</p> <p>(25)</p>	5		
<p> Button Head⁷ 10-24 x 3/4 68033 T-25 Driver</p> <p>(25)</p>	<p> Button Head⁸ 10-24 x 1 68034 T-25 Driver</p> <p>(25)</p>	9		10	11	
<p>10 PC. Driver Kit 68091</p> <p>(1)</p>						
<p> Flat Head¹² 6-32 x 1/2 68054 T-10 Driver</p> <p>(25)</p>	<p> Flat Head¹³ 8-32 x 3/8 68060 T-15 Driver</p> <p>(25)</p>	<p> Flat Head¹⁴ 8-32 x 1/2 68061 T-15 Driver</p> <p>(25)</p>	<p> Flat Head¹⁵ 8-32 x 3/4 68062 T-15 Driver</p> <p>(25)</p>	<p> Flat Head¹⁶ 8-32 x 1 68063 T-15 Driver</p> <p>(25)</p>		
<p> Flat Head¹⁷ 10-24 x 1/2 68068 T-20 Driver</p> <p>(25)</p>	<p> Flat Head¹⁸ 10-24 x 3/4 68069 T-20 Driver</p> <p>(25)</p>	<p> Flat Head¹⁹ 1/4 x 3/4 68081 T-27 Driver</p> <p>(25)</p>	<p> Flat Head²⁰ 1/4 x 1 68082 T-27 Driver</p> <p>(25)</p>	21		

CD - 202 Square Keystock
99906 Long Space Tray

CHOICE
DISTRIBUTION

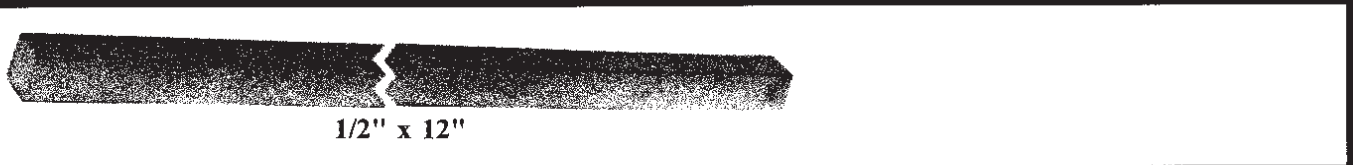
CD-202 Square Keystock

111 BELL STREET
W. BABYLON, NY 11704
(631) 756-0120

<p>33982</p> <p>5/8" x 12"</p>	<p>1</p> 	<p>1</p> <p>33983</p> <p>3/4" x 12"</p>
<p>2</p> <p>33980</p>	 <p>1/2" x 12"</p>	
<p>5</p> <p>33978</p>	 <p>3/8" x 12"</p>	
<p>5</p> <p>33977</p>	 <p>5/16" x 12"</p>	
<p>5</p> <p>33976</p>	 <p>1/4" x 12"</p>	
<p>5</p> <p>33975</p>	 <p>3/16" x 12"</p>	

CD - 203 Stainless Steel Hose Clamps 99926 10 Loop Hose Rack

ALL STAINLESS STEEL HOSE CLAMPS

Offers maximum protection against corrosion
Excellent for use in:

- Marine
- Automotive
- Chemical
- Dairy
- Food Processing

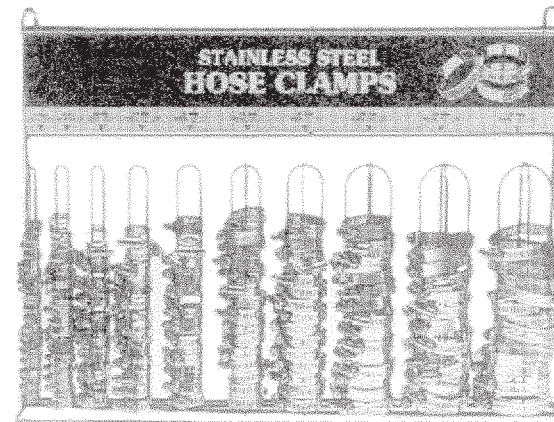

CHOICE #	Mfgr. #	Clamp Diameter		Qty.
		Min.	Max.	
22004	4	7/32"	5/8"	10
22006	6	7/16"	25/32"	10
22010	10	7/32"	1"	10
22012	12	11/16"	1-1/4"	10
22016	16	13/16"	1-1/2"	10
22020	20	13/16"	1-3/4"	10
22028	28	1-5/16"	2-1/4"	10
22032	32	1-9/16"	2-1/2"	10
22036	36	1-13/16"	2-3/4"	10
99926	*	*	*	1
Label Range	*	*	*	1

CD - 204 Hose Clamps 99926 10 Loop Hose Rack

Hose Clamp Assortment

- **Slotted**, hex, steel, screw head.
- **Housing** and band are stainless steel.

CHOICE #	Mfgr. #	Clamp Diameter		Qty.
		Min.	Max.	
2004	4	7/32"	5/8"	10
2006	6	7/16"	25/32"	10
2010	10	7/32"	1"	10
2012	12	11/16"	1-1/4"	10
2016	16	13/16"	1-1/2"	10
2020	20	13/16"	1-3/4"	10
2028	28	1-5/16"	2-1/4"	10
2032	32	1-9/16"	2-1/2"	10
2036	36	1-13/16"	2-3/4"	10
99926	*	*	*	1
Label Range	*	*	*	1

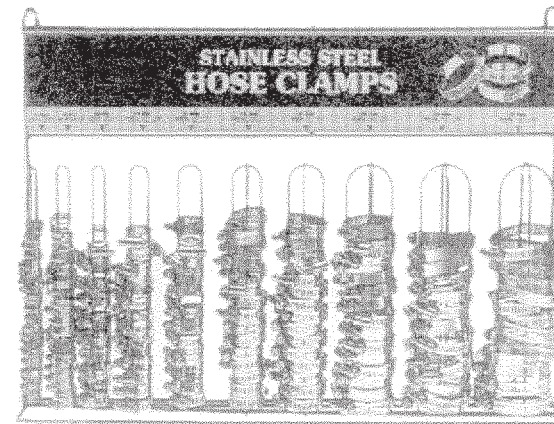

CHOICE
DISTRIBUTION

CD-205 T & B TY-RAPS

111 BELL STREET
 W. BABYLON, NY 11704
 (516) 756-0120

50



26308
 7.81" TY-RAP
 WIDTH - .184
 MIN. TENSILE STRENGTH 50 LBS.
 WIRE BUNDLE RANGE 1/16" - 1 3/4"

50



26303
BLACK
 7.31" TY-RAP
 WIDTH - .184
 MIN. TENSILE STRENGTH 50 LBS.
 WIRE BUNDLE RANGE 1/16" - 1 3/4"

10



6899
 TWO-WAY ADHESIVE
 MOUNTING BASE

50



26302
 7.31" TY-RAP
 WIDTH - .184
 MIN. TENSILE STRENGTH 50 LBS.
 WIRE BUNDLE RANGE 1/16" - 1 3/4"

10



6900
 SMALL
 TWO-WAY ADHESIVE
 MOUNTING BASE

50



26301
 5.50" TY-RAP
 WIDTH - .140
 MIN. TENSILE STRENGTH 30 LBS.
 WIRE BUNDLE RANGE 1/16" - 1-1/4"

50

26300
 3.62" TY-RAP
 WIDTH - .094
 MIN. TENSILE STRENGTH 18 LBS.
 WIRE BUNDLE RANGE 1/16" - 5/8"



CHOICE
DISTRIBUTION

CD-206 T & B TY-RAPS

111 BELL STREET
W. BABYLON, NY 11704
(516) 756-0120

10



26306

13.38" TY-RAP

WIDTH - .301

MIN. TENSILE STRENGTH 120 LBS.

WIRE BUNDLE RANGE 3/16" - 3 1/2"

10



26310

13.93" TY-RAP

WIDTH - .301

MIN. TENSILE STRENGTH 120 LBS.

WIRE BUNDLE RANGE 3/16" - 3 1/2"

25



26304

14.19" TY-RAP

WIDTH - .184

MIN. TENSILE STRENGTH 50 LBS.

WIRE BUNDLE RANGE 1/16" - 4"

25



26309

14.60" TY-RAP

WIDTH - .184

MIN. TENSILE STRENGTH 50 LBS.

WIRE BUNDLE RANGE 1/16" - 4"

10



26307

13.38" TY-RAP

WIDTH - .301

MIN. TENSILE STRENGTH 120 LBS.

WIRE BUNDLE RANGE 1/16" - 3 1/2"

25



26315

11.41" TY-RAP





















WIDTH - .184

MIN. TENSILE STRENGTH 50 LBS.

WIRE BUNDLE RANGE 1/16" - 3"

CD - 207 Crimp, Solder, & Seal
 99937 20 Space Tray
 99936 Outside Shell

CHOICE
CHOICE
 DISTRIBUTION INC.
www.choice-distribution.com

CHOICE DISTRIBUTION		CD-207 Crimp, Solder, & Seal Terminals		111 BELL STREET W. BABYLON, NY 11704 (631) 756-0120	
29900	1	29906	2	29901	3
	10		10		10
RING 22-18 Wire 6-8 Stud Size RED		RING 16-14 Wire 6-8 Stud Size BLUE		RING 22-18 Wire 8-10 Stud Size RED	
57230	4	29907	5	29913	6
	10		10		10
MULTI-CRIMP CONN. 22-18 Wire RED		RING 16-14 Wire 8-10 Stud Size BLUE		RING 12-10 Wire 8-10 Stud Size YELLOW	
29909	7	29915	9	29916	10
	10		10		10
RING 16-14 Wire 1/4 Stud Size BLUE		RING 12-10 Wire 1/4 Stud Size YELLOW		RING 12-10 Wire 5/16 Stud Size YELLOW	
57231	8	29920	13	29923	14
	10		10		10
MULTI-CRIMP CONN. 16-14 Wire BLUE		SPADE 22-18 Wire 8-10 Stud Size RED		SPADE 16-14 Wire 8-10 Stud Size BLUE	
29926	11	29937	17	29938	18
	10		10		10
SPADE 12-10 Wire 8-10 Stud Size YELLOW		FEMALE PUSH ON 22-18 Wire RED		MALE PUSH ON 22-18 Wire RED	
57232	12	29939	15	29940	19
	10		10		10
MULTI-CRIMP CONN. 12-10 Wire YELLOW		FEMALE PUSH ON 16-14 Wire BLUE		MALE PUSH ON 16-14 Wire BLUE	
29941	16	29942	20		
	10		10		
FEMALE PUSH ON 12-10 Wire YELLOW		MALE PUSH ON 12-10 Wire YELLOW			

CHOICE
DISTRIBUTION

CD-208 CIRCUIT BREAKERS

111 BELL STREET
W. BABYLON, NY 11704
(516) 756-0120

2



1

28600 - 15 amp

Universal 6-12 & 24 volt.
With mounting bracket, nuts and lock washers.
24 volt applications limited to resistive loads, lamp loads,
and a few inductive loads.
Overall size: 2" x 25/32" x 1-3/8"

2



2

28555 - 10 amp

GLASS FUSE CLIP MOUNTING
For 12V (dc) systems only
Replaces 3AG (AGC) and SFE 20 amp glass fuses.
Snap-in mounting in standard fuse clips.
Size (W x H): 1/4" x 1-1/4" (6.35mm x 31.7mm).

1



3

28559 - 30 amp

GLASS FUSE CLIP MOUNTING
For 12V (dc) systems only
Replaces 3AG (AGC) and SFE 20 amp glass fuses.
Snap-in mounting in standard fuse clips.
Size (W x H): 1/4" x 1-1/4" (6.35mm x 31.7mm).

2



4

28547 - 20 amp

TYPE I - CYCLING CIRCUIT BREAKERS
Plug-in type.
Rated at 12V (dc).
Universal "plug-in" mounted circuit breakers.
Heavy-duty replacement for ATC and ATO blade-type fuses.
Terminals are grooved for easy size adjustment - snap off
with pliers.
Saves time and cost for replacement of burnt-out fuses.
Overall size (L x W x H): .84" x .40" x 1.5" (21.33 x 10.16mm x 38.10mm)

2



5

28602 - 20 amp

Universal 6-12 & 24 volt.
With mounting bracket, nuts and lock washers.
24 volt applications limited to resistive loads, lamp loads,
and a few inductive loads.
Overall size: 2" x 25/32" x 1-3/8"

2



6

28556 - 15 amp

GLASS FUSE CLIP MOUNTING
For 12V (dc) systems only
Replaces 3AG (AGC) and SFE 20 amp glass fuses.
Snap-in mounting in standard fuse clips.
Size (W x H): 1/4" x 1-1/4" (6.35mm x 31.7mm).

1



7

28560 - 40 amp

GLASS FUSE CLIP MOUNTING
For 12V (dc) systems only
Replaces 3AG (AGC) and SFE 20 amp glass fuses.
Snap-in mounting in standard fuse clips.
Size (W x H): 1/4" x 1-1/4" (6.35mm x 31.7mm).

1



8

28548 - 25 amp

TYPE I - CYCLING CIRCUIT BREAKERS
Plug-in type.
Rated at 12V (dc).
Universal "plug-in" mounted circuit breakers.
Heavy-duty replacement for ATC and ATO blade-type fuses.
Terminals are grooved for easy size adjustment - snap off
with pliers.
Saves time and cost for replacement of burnt-out fuses.
Overall size (L x W x H): .84" x .40" x 1.5" (21.33 x 10.16mm x 38.10mm)

2



9

28604 - 30 amp

Universal 6-12 & 24 volt.
With mounting bracket, nuts and lock washers.
24 volt applications limited to resistive loads, lamp loads,
and a few inductive loads.
Overall size: 2" x 25/32" x 1-3/8"

2



10

28557 - 20 amp

GLASS FUSE CLIP MOUNTING
For 12V (dc) systems only
Replaces 3AG (AGC) and SFE 20 amp glass fuses.
Snap-in mounting in standard fuse clips.
Size (W x H): 1/4" x 1-1/4" (6.35mm x 31.7mm).

2



11

28545 - 10 amp

TYPE I - CYCLING CIRCUIT BREAKERS
Plug-in type.
Rated at 12V (dc).
Universal "plug-in" mounted circuit breakers.
Heavy-duty replacement for ATC and ATO blade-type fuses.
Terminals are grooved for easy size adjustment - snap off
with pliers.
Saves time and cost for replacement of burnt-out fuses.
Overall size (L x W x H): .84" x .40" x 1.5" (21.33 x 10.16mm x 38.10mm)

1

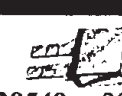

12

28549 - 30 amp

TYPE I - CYCLING CIRCUIT BREAKERS
Plug-in type.
Rated at 12V (dc).
Universal "plug-in" mounted circuit breakers.
Heavy-duty replacement for ATC and ATO blade-type fuses.
Terminals are grooved for easy size adjustment - snap off
with pliers.
Saves time and cost for replacement of burnt-out fuses.
Overall size (L x W x H): .84" x .40" x 1.5" (21.33 x 10.16mm x 38.10mm)

1



13

28606 - 40 amp

Universal 6-12 & 24 volt.
With mounting bracket, nuts and lock washers.
24 volt applications limited to resistive loads, lamp loads,
and a few inductive loads.
Overall size: 2" x 25/32" x 1-3/8"

2



14

28558 - 25 amp

GLASS FUSE CLIP MOUNTING
For 12V (dc) systems only
Replaces 3AG (AGC) and SFE 20 amp glass fuses.
Snap-in mounting in standard fuse clips.
Size (W x H): 1/4" x 1-1/4" (6.35mm x 31.7mm).

2







15

28546 - 15 amp

TYPE I - CYCLING CIRCUIT BREAKERS
Plug-in type.
Rated at 12V (dc).
Universal "plug-in" mounted circuit breakers.
Heavy-duty replacement for ATC and ATO blade-type fuses.
Terminals are grooved for easy size adjustment - snap off
with pliers.
Saves time and cost for replacement of burnt-out fuses.
Overall size (L x W x H): .84" x .40" x 1.5" (21.33 x 10.16mm x 38.10mm)

16

CD - 209 Multiple Wall Heat Shrink Tubing
99905 Adjustable Space Tray

CHOICE DISTRIBUTION	CD-209 Multiple Wall Heat Shrink Tubing			111 BELL STREET W. BABYLON, NY 11704 (516) 756-0120
<p data-bbox="294 479 367 544">8</p> <p data-bbox="262 682 388 722">12950</p> <p data-bbox="220 820 430 901">Clear Adhesive Lined 1/8" ID 24-22 Wire Range</p> 	<p data-bbox="703 479 777 544">8</p> <p data-bbox="693 682 819 722">12951</p> <p data-bbox="661 820 861 901">Red Adhesive Lined 3/16" ID 22-18 Wire Range</p> 	<p data-bbox="1113 479 1186 544">8</p> <p data-bbox="1144 682 1270 722">12952</p> <p data-bbox="1102 820 1302 901">Blue Adhesive Lined 1/4" ID 16-14 Wire Range</p> 	<p data-bbox="1554 479 1627 544">8</p> <p data-bbox="1596 682 1722 722">12953</p> <p data-bbox="1554 820 1774 901">Yellow Adhesive Lined 5/16" ID 12-10 Wire Range</p> 	

CHOICE
DISTRIBUTION

CD-210 Heat Shrink Tubing

111 BELL STREET
W. BABYLON, NY 11704
(631) 756-0120

79005

**3/4" DIA.
6" LENGTH
HEAT SHRINK
TUBING**

FLAME RETARDANT

10

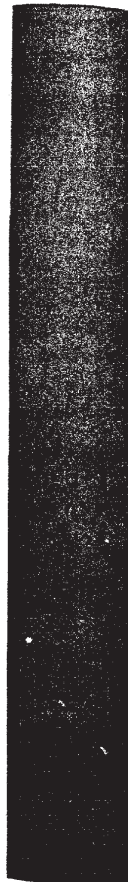

79004

**1/2" DIA.
6" LENGTH
HEAT SHRINK
TUBING**

FLAME RETARDANT

10



79003

**3/8" DIA.
6" LENGTH
HEAT SHRINK
TUBING**

FLAME RETARDANT

20



79001

**3/16" DIA.
6" LENGTH
HEAT SHRINK
TUBING**

FLAME RETARDANT

20

















79002

**1/4" DIA.
6" LENGTH
HEAT SHRINK
TUBING**

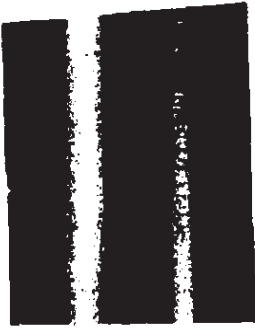
FLAME RETARDANT

20

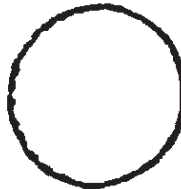
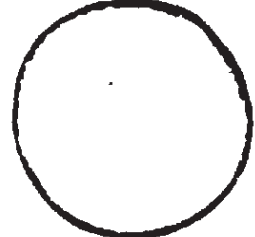

CHOICE DISTRIBUTION		CD-211 HEAT SHRINK TUBIN		111 BELL STREET W. BABYLON, NY 11704 (516) 756-0120	
 2	27011	 2	27012	 1	27013
	8-6 Gauge RED		6-2/0 Gauge RED		4-4/0 Gauge RED
 1	27014	 2	27001	 2	27002
	2-6/0 Gauge RED		8-6 Gauge BLACK		6-2/0 Gauge BLACK
 1	27003		4-4/0 Gauge BLACK	 1	27004
	2-6/0 Gauge BLACK				

CD - 212 Large Size Hose Clamps
 99933 5 Loop Hose Rack

LARGE SIZE HOSE CLAMPS

CD-212



- Slotted, hex, steel, screw head.
- Housing and band are stainless steel.

CHOICE #	Mfgr. #	Clamp Diameter		Qty.
		Min.	Max.	
2040	40	1-9/16"	2-1/2"	10
2048	48	1-13/16"	2-3/4"	5
2052	52	2-9/16"	3-1/2"	5
2056	56	3-5/16"	4-1/2"	5
2072	72	3-13/16"	4-3/4"	5
99933	*	*	*	1
Label Range	*	*	*	1

CD - 213 Large Stainless Steel Hose Clamps
 99933 5 Loop Hose Rack







LARGE STAINLESS STEEL HOSE CLAMPS
CD-213













•Slotted, hex, steel, screw head.

CHOICE #	Mfgr. #	Clamp Diameter		Qty.
		Min.	Max.	
22040	40	1-9/16"	2-1/2"	10
22048	48	1-13/16"	2-3/4"	5
22000-52	52	2-9/16"	3-1/2"	5
22000-56	56	3-5/16"	4-1/2"	5
22000-72	72	4-1/16"	5"	5
99933	*	*	*	1
Label Range	*	*	*	1

CD - 214 Black Ty-Raps
99906 Long Space Tray

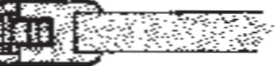
CHOICE DISTRIBUTION	CD-214 BLACK TY-RAPS				111 BELL STREET W. BABYLON, NY 11704 (631) 756-0120	
10		26313	3.62' TY-RAP	WIDTH - .094	MIN. TENSILE STRENGTH 18 LBS.	WIRE BUNDLE RANGE 3/16" TO 3/8"
10		26314	5.50' TY-RAP	WIDTH - .140	MIN. TENSILE STRENGTH 30 LBS.	WIRE BUNDLE RANGE 1/16" TO 1-1/4"
10		26303	7.51' TY-RAP	WIDTH - .18-	MIN. TENSILE STRENGTH 50 LBS.	WIRE BUNDLE RANGE 1/16" TO 1-3/4"
10		26307	13.38' TY-RAP	WIDTH - .301	MIN. TENSILE STRENGTH 120 LBS.	WIRE BUNDLE RANGE 3/16" TO 3-1/2"
10		26319	14.19' TY-RAP	WIDTH - .184	MIN. TENSILE STRENGTH 50 LBS.	WIRE BUNDLE RANGE UP TO 4'
10		26319	14.19' TY-RAP	WIDTH - .184	MIN. TENSILE STRENGTH 50 LBS.	WIRE BUNDLE RANGE UP TO 4'

CD - 215 Black Low Profile Ty-Raps
99906 Long Space Tray

CHOICE DISTRIBUTION	CD-215 Black Low Profile Ty-Raps		111 BELL STREET W. BABYLON, NY 11704 (631) 756-0120
57310 4.655 in. Black			50
57314 7.695 in. Black			50
57316 11.33 in. Black			50
57316 11.33 in. Black			
57318 14.535 in. Black			25
57318 14.535 in. Black			

CD - 216 T & B Low-Profile Safe_Ty-Raps
99906 Long Space Tray

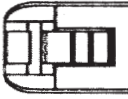
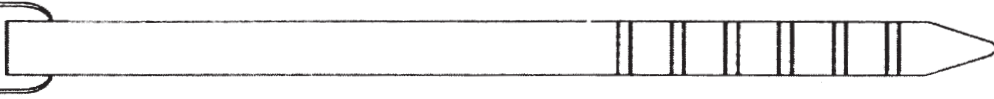
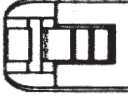
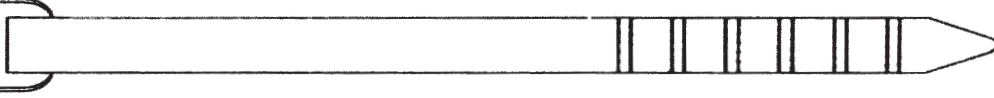
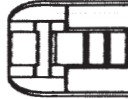
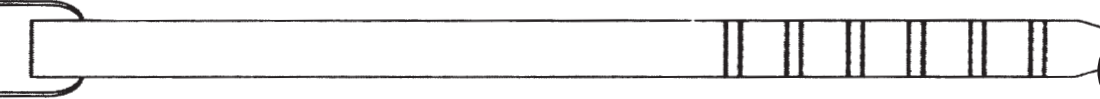
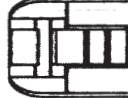
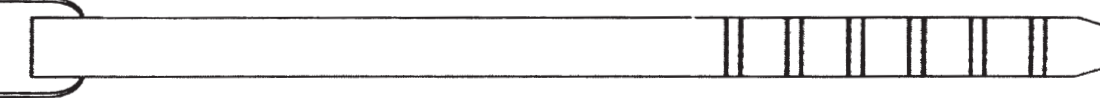
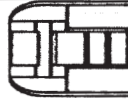
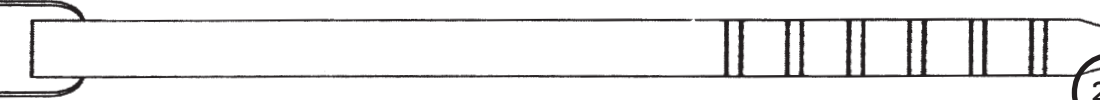
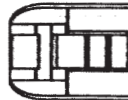
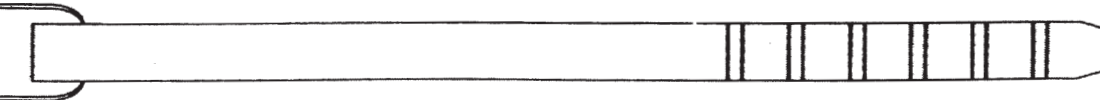
CHOICE DISTRIBUTION	CD-216 T&B Low Profile Safe_Ty		111 BELL STREET W. BABYLON, NY 11704 (631) 756-0120
57300 4.655 in. White			50
57300 4.655 in. White			
57306 11.33 in. White			50
57306 11.33 in. White			
57308 14.535 in. White			25
57308 14.535 in. White			

CD - 217 Black Ty-Raps
99905 Adjustable Space Tray
5 each

CHOICE
CHOICE
DISTRIBUTION INC.
www.choice-distribution.com

CHOICE
DISTRIBUTION

CD-217 Lined Loom Clips 1/4 Hole

111 BELL STREET
W. BABYLON, NY 11704
(516) 756-0120

80040



1/4 in. Loom Clip

80041



3/8 in. Loom Clip

80042



1/2 in. Loom Clip

80043



5/8 in. Loom Clip

80044

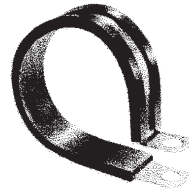

3/4 in. Loom Clip

80045

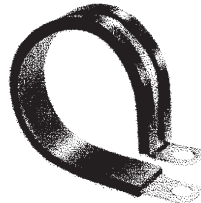

7/8 in. Loom Clip

80046

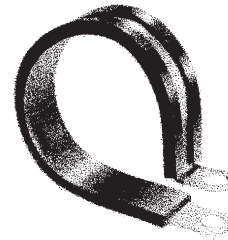

1 in. Loom Clip

80047

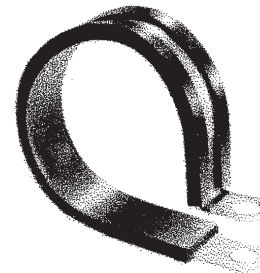

1-1/8 in. Loom Clip

80048

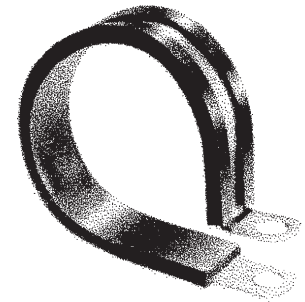

1-1/4 in. Loom Clip

80049

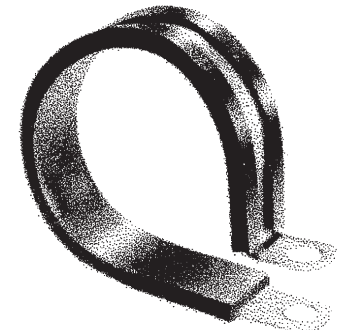

1-3/8 in. Loom Clip

CD - 218 Black Ty-Raps
99905 Adjustable Space Tray
4 each

CHOICE
CHOICE
DISTRIBUTION INC.
www.choice-distribution.com

CHOICE
DISTRIBUTION

CD-218 Lined Loom Clips 1/4" Hole

111 BELL STREET
W. BABYLON, NY 11704
(516) 756-0120

80050

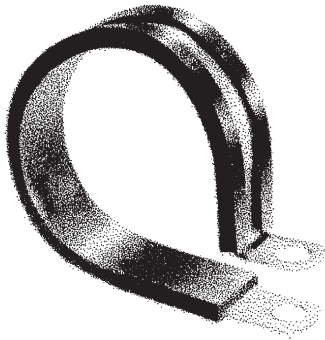

1-1/2 in. Loom Clip

80052

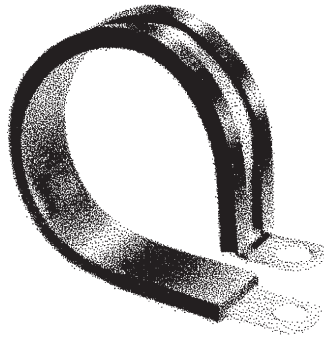

1-3/4 in. Loom Clip

80054

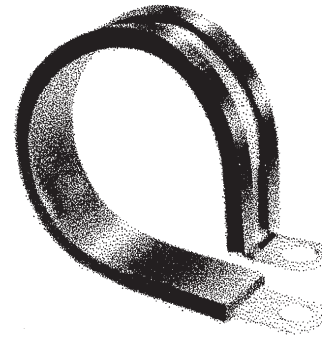

2 in. Loom Clip

80056

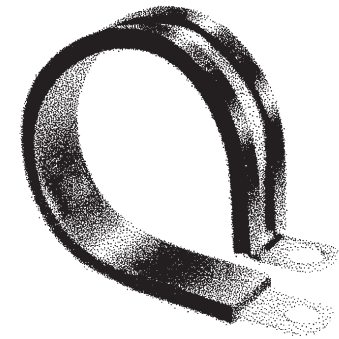

2-1/4 in. Loom Clip

80051

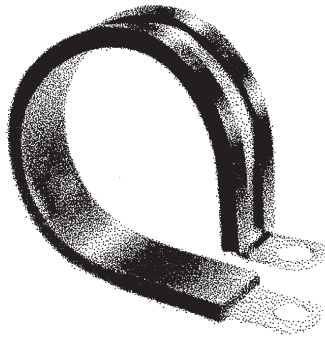

1-5/8 in. Loom Clip

80053

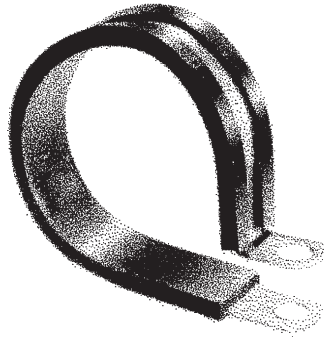

1-7/8 in. Loom Clip

80055

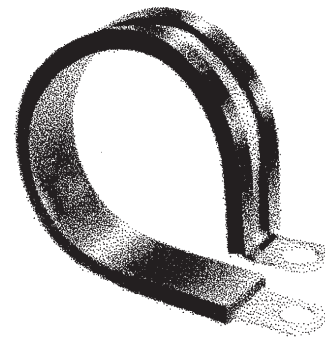

2-1/8 in. Loom Clip

80058

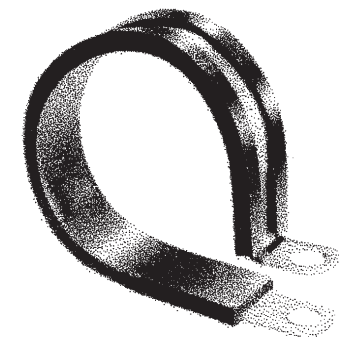













2-1/2 in. Loom Clip

Pictures not actual size

CD - 219 Pro-Tech II Nytrex Terminals
 99937 20 Space Tray
 99936 Outside Shell

CHOICE
CHOICE
 DISTRIBUTION INC.
www.choice-distribution.com

CHOICE DISTRIBUTION		PRO-TECH II NYTREX TERMINALS				111 BELL STREET W. BABYLON, NY 11704 (631) 756-0120	
<p>CSC-928-10 1</p> <p>5  12-10 Gauge #8-10 Ring</p>	<p>CSB-937-10 2</p> <p>5  16-14 Gauge #8-10 Ring</p>	<p>CSA-921-10 3</p> <p>5  22-18 Gauge #8-10 Ring</p>			4		
<p>CSC-930-14 5</p> <p>5  12-10 Gauge #12-1/4 Ring</p>	<p>CSB-925-14 6</p> <p>5  16-14 Gauge #12-1/4 Ring</p>	<p>CSA-935-10 7</p> <p>5  22-18 Gauge #8-10 Spade</p>			8		
<p>CSC-940-38 9</p> <p>5  12-10 Gauge 5/16-3/8 Ring</p>	<p>CSBB-9263 10</p> <p>5  16-14 Gauge 1/4 Female Q-Slide</p>	<p>CSASN-345 11</p> <p>5  22-18 Gauge Butt Connector</p>			12		
<p>CSCSN-346 13</p> <p>5  12-10 Gauge Butt Connector</p>	<p>CSBB-9262 14</p> <p>5  16-14 Gauge 1/4 Male Q-Slide</p>	15		16			
17		<p>CSBSN-331 18</p> <p>10  16-14 Gauge Butt Connector</p>	19		20		

**CHOICE
 DISTRIBUTION**

CD-220 SAIT-LOCK DISCS

111 BELL STREET
 W. BABYLON, NY 11704
 (516) 756-0120

3602

3

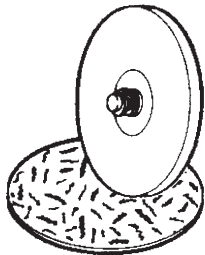

2" Medium SAIT-LOCK Disc

3608

3

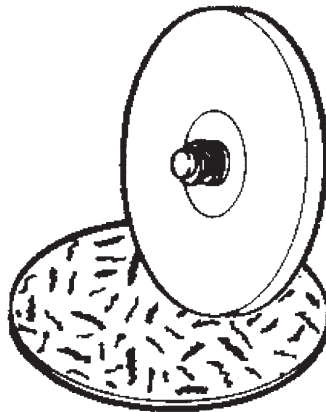

3" Medium SAIT-LOCK Disc

3610

3

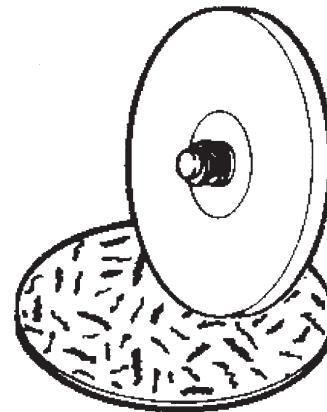

3" Course SAIT-LOCK Disc

3606

1

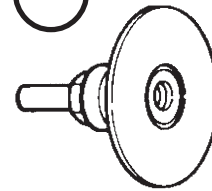

2" SAIT-LOK-R System Disc Pad

3604

3

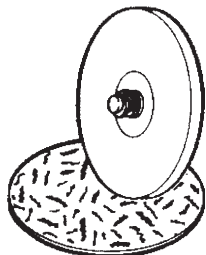

2" Course SAIT-LOCK Disc

3612

1

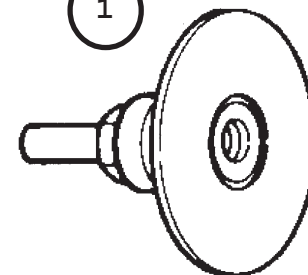











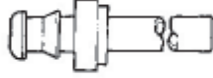



3" SAIT-LOK-R System Disc Pad









Pictures not actual size

CD - 230 1/4 Reusabel Hose Ends
 99903 16 Space Tray
 3 each

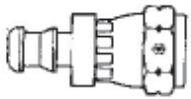



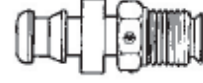
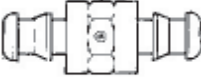

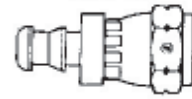
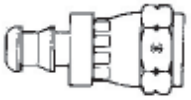



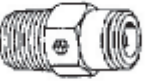
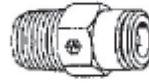
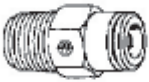

CHOICE
CHOICE
 DISTRIBUTION INC.
www.choice-distribution.com

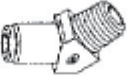
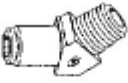
CHOICE DISTRIBUTION		CD-230 1/4 Hose Reusable Hose Ends		111 BELL STREET W. BABYLON, NY 11704 (516) 756-0120			
1	90740  Male Pipe 1/4" Hose 1/8 P.T.	2	90742  Male Pipe 1/4" Hose 1/4 P.T.	3	90774  SAERigid Male 1/4" Hose 5/16 P.T.	4	90760  Rigid Pipe 1/4" Hose 3/16 Tube
5	90773  SAERigid Male 1/4" Hose 1/4 P.T.	6	90788  Rigid Inverted Swivel 1/4" Hose 3/16 Tube	7	90789  Rigid Inverted Swivel 1/4" Hose 1/4 Tube	8	90761  Rigid Pipe 1/4" Hose 1/4 Tube
9	90790  Rigid Inverted Swivel 1/4" Hose 5/16 Tube	10	90765  SAESwivel 1/4" Hose 1/4 Tube	11	90766  SAESwivel 1/4" Hose 5/16 Tube	12	90762  Rigid Pipe 1/4" Hose 5/16 Tube
13	90779  Inverted Male Swivel 1/4" Hose 3/16 Tube	14	90780  Inverted Male Swivel 1/4" Hose 1/4 Tube	15	90781  Inverted Male Swivel 1/4" Hose 5/16 Tube	16	90755  Hose Mender 1/4" Hose

CD - 232 3/8 & 1/2 Reusable Hose Ends
 99903 16 Space Tray
 3 each

CHOICE DISTRIBUTION		CD-232 3/8 & 1/2 Hose Reusable Hose Ends		111 BELL STREET W. BABYLON, NY 11704 (516) 756-0120	
<p>90744 1</p>  <p>Male Pipe 3/8" Hose 1/4 P.T.</p>	<p>90745 2</p>  <p>Male Pipe 3/8" Hose 3/8 P.T.</p>	<p>90775 3</p>  <p>SAE Rigid Male 3/8" Hose 3/8 P.T.</p>	<p>90768 4</p>  <p>SAE Swivel 3/8" Hose 3/8 Tube</p>		
<p>90770 5</p>  <p>JIC Swivel 3/8" Hose 3/8 Tube</p>	<p>90756 6</p>  <p>Hose Mender 3/8" Hose</p>	<p>90791 7</p>  <p>Rigid Inverted Swivel 3/8" Hose 3/8 Tube</p>	<p>90783 8</p>  <p>Inverted Male Swivel 3/8" Hose 3/8 Tube</p>		
<p>90757 9</p>  <p>Hose Mender 1/2" Hose</p>	<p>90746 10</p>  <p>Male Pipe 1/2" Hose 3/8 P.T.</p>	<p>90747 11</p>  <p>Male Pipe 1/2" Hose 1/2 P.T.</p>	<p>90769 12</p>  <p>SAE Swivel 1/2" Hose 1/2 Tube</p>		
<p>90771 13</p>  <p>JIC Swivel 1/2" Hose 1/2 Tube</p>	14	15	16		

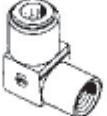
CD - 235 3/16 & 1/4 Quick Connect Air Brake
 99903 16 Space Tray
 2 each

CHOICE DISTRIBUTION		CD-235 ^{3/16 & 1/4} Quick Connect Air Brake		111 BELL STREET W. BABYLON, NY 11704 (516) 756-0120	
1	89101  Union 1/4 tube	2	89120  Male Connector 3/16 tube x 1/8 pipe	3	89121  Male Connector 1/4 tube x 1/8 pipe
		4	89122  Male Connector 1/4 tube x 1/4 pipe	5	89123  Male Connector 1/4 tube x 3/8 pipe
		6	89150  Female Connector 1/4 tube x 1/8 pipe	7	89151  Female Connector 1/4 tube x 1/4 pipe
		8	89160  45° Male Elbow 1/4 tube x 1/8 pipe	9	89161  45° Male Elbow 1/4 tube x 1/4 pipe
		10	89170  Union Elbow 1/4 tube	11	89185  90° Male Elbow 3/16 tube x 1/8 pipe
		12	89186  90° Male Elbow 1/4 tube x 1/8 pipe	13	89187  90° Male Elbow 1/4 tube x 1/4 pipe
		14	89188  90° Male Elbow 1/4 tube x 3/8 pipe	15	89200  Female Elbow 1/4 tube x 1/8 pipe
		16	89201  Female Elbow 1/4 tube x 1/4 pipe		











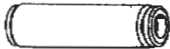



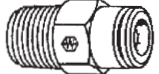

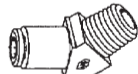

CD - 236 3/8 Quick Connect Air Brake
 99937 20 Space Tray
 99936 Outside Shell
 2 each

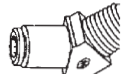
CHOICE
CHOICE
 DISTRIBUTION INC.
www.choice-distribution.com









CHOICE
DISTRIBUTION

CD-236 3/8 Quick Connect Air Brake

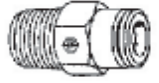
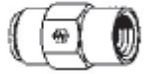
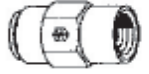

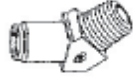
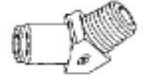
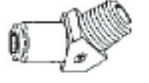
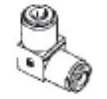



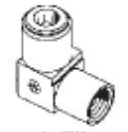
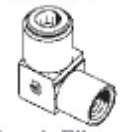









111 BELL STREET
 W. BABYLON, NY 11704
 (631) 756-0120

<p>89102 1</p>  <p>Union 3/8 tube</p>	<p>89124 2</p>  <p>Male Connector 3/8 tube x 1/8 pipe</p>	<p>89125 3</p>  <p>Male Connector 3/8 tube x 1/4 pipe</p>	<p>89126 4</p>  <p>Male Connector 3/8 tube x 3/8 pipe</p>
<p>89127 5</p>  <p>Male Connector 3/8 tube x 1/2 pipe</p>	<p>89152 6</p>  <p>Female Connector 3/8 tube x 1/8 pipe</p>	<p>89153 7</p>  <p>Female Connector 3/8 tube x 1/4 pipe</p>	<p>89154 8</p>  <p>Female Connector 3/8 tube x 3/8 pipe</p>
<p>89162 9</p>  <p>45° Male Elbow 3/8 tube x 1/8 pipe</p>	<p>89163 10</p>  <p>45° Male Elbow 3/8 tube x 1/4 pipe</p>	<p>89164 11</p>  <p>45° Male Elbow 3/8 tube x 3/8 pipe</p>	<p>89165 12</p>  <p>45° Male Elbow 3/8 tube x 1/2 pipe</p>
<p>89171 13</p>  <p>Union Elbow 3/8 tube</p>	<p>89189 14</p>  <p>90° Male Elbow 3/8 tube x 1/8 pipe</p>	<p>89190 15</p>  <p>90° Male Elbow 3/8 tube x 1/4 pipe</p>	<p>89191 16</p>  <p>90° Male Elbow 3/8 tube x 3/8 pipe</p>
<p>89192 17</p>  <p>90° Male Elbow 3/8 tube x 1/2 pipe</p>	<p>89202 18</p>  <p>Female Elbow 3/8 tube x 1/8 pipe</p>	<p>89203 19</p>  <p>Female Elbow 3/8 tube x 1/4 pipe</p>	<p>89204 20</p>  <p>Female Elbow 3/8 tube x 3/8 pipe</p>

















CD - 237 1/2 Quick Connect Air Brake
 99903 16 Space Tray
 2 each

CHOICE DISTRIBUTION		CD-237 1/2 Quick Connect Air Brake				111 BELL STREET W. BABYLON, NY 11704 (516) 756-0120	
1	89103  Union 1/2 tube	2	89128  Male Connector 1/2 tube x 1/4 pipe	3	89129  Male Connector 1/4 tube x 3/8 pipe	4	89130  Male Connector 1/2 tube x 1/2 pipe
5	89155  Female Connector 1/2 tube x 1/4 pipe	6	89156  Female Connector 1/2 tube x 3/8 pipe	7	89157  Female Connector 1/2 tube x 1/2 pipe	8	89166  45° Male Elbow 1/2 tube x 1/4 pipe
9	89167  45° Male Elbow 1/2 tube x 3/8 pipe	10	89168  45° Male Elbow 1/2 tube x 1/2 pipe	11	89172  Union Elbow 1/2 tube	12	89193  90° Male Elbow 1/2 tube x 1/4 pipe
13	89194  90° Male Elbow 1/2 tube x 3/8 pipe	14	89195  90° Male Elbow 1/2 tube x 1/2 pipe	15	89206  Female Elbow 1/2 tube x 3/8 pipe	16	89207  Female Elbow 1/2 tube x 1/2 pipe

CD - 240 18-8 Stainless Steel Cotter Pins
99903 16 Space Tray





















CHOICE DISTRIBUTION		CD-240 18-8 Stainless Steel Cotter Pins				111 BELL STREET W. BABYLON, NY 11704 (631) 756-0120	
<p>69909 ¹ 25</p>  <p>1/16" x 3/4"</p>	<p>69910 ² 25</p>  <p>1/16" x 1"</p>	<p>69917 ³ 25</p>  <p>3/32" x 1"</p>	<p>69918 ⁴ 25</p>  <p>3/32" x 1 1/4"</p>	<p>69919 ⁵ 25</p>  <p>3/32" x 1 1/2"</p>	<p>69921 ⁶ 25</p>  <p>3/32" x 2"</p>	<p>69930 ⁷ 25</p>  <p>1/8" x 1 1/4"</p>	<p>69931 ⁸ 25</p>  <p>1/8" x 1 1/2"</p>
<p>69932 ⁹ 25</p>  <p>1/8" x 1 3/4"</p>	<p>69933 ¹⁰ 25</p>  <p>1/8" x 2"</p>	<p>69939 ¹¹ 25</p>  <p>5/32" x 1 1/2"</p>	<p>69940 ¹² 25</p>  <p>5/32" x 1 3/4"</p>	<p>69941 ¹³ 10</p>  <p>5/32" x 2"</p>	<p>69948 ¹⁴ 10</p>  <p>3/16" x 1 1/2"</p>	<p>69950 ¹⁵ 10</p>  <p>3/16" x 2"</p>	<p>69952 ¹⁶ 10</p>  <p>3/16" x 2 1/2"</p>

CD - 241 316 Stainless Steel Cotter Pins
99903 16 Space Tray





















CHOICE DISTRIBUTION	CD-241 316 Stainless Steel Cotter Pins				111 BELL STREET W. BABYLON, NY 11704 (631) 756-0120
<p>74451  25¹</p> <p>1/16" x 3/4"</p>	<p>74452  25²</p> <p>1/16" x 1"</p>	<p>74454  25³</p> <p>3/32" x 3/4"</p>	<p>74455  25⁴</p> <p>3/32" x 1"</p>		
<p>74456  25⁵</p> <p>3/32" x 1 1/4"</p>	<p>74457  25⁶</p> <p>3/32" x 1 1/2"</p>	<p>74458  25⁷</p> <p>1/8" x 3/4"</p>	<p>74459  25⁸</p> <p>1/8" x 1"</p>		
<p>74460  25⁹</p> <p>1/8" x 1 1/4"</p>	<p>74461  25¹⁰</p> <p>1/8" x 1 1/2"</p>	<p>74462  25¹¹</p> <p>1/8" x 2"</p>	<p>74463  25¹²</p> <p>5/32" x 1"</p>		
<p>74464  10³</p> <p>5/32" x 2"</p>	<p>74465  10¹⁴</p> <p>3/16" x 1"</p>	<p>74466  10¹⁵</p> <p>3/16" x 1 1/2"</p>	<p>74467  10¹⁶</p> <p>3/16" x 2"</p>		

CD - 250 Stainless Steel Phillips Binding Head
Sheet Metal Screws
99902 24 Space Tray

CHOICE
CHOICE
DISTRIBUTION INC.
www.choice-distribution.com

CHOICE DISTRIBUTION		CD-250 Stainless Steel Phillips Binding Head Sheet Metal Screws				111 BELL STREET W. BABYLON, NY 11704 (516) 756-0120	
25 62811 1  6 x 3/8"	25 62812 2  6 x 1/2"	25 62814 3  6 x 3/4"	25 62816 4  6 x 1"	25 62821 5  8 x 3/8"	25 62822 6  8 x 1/2"		
25 62824 7  8 x 3/4"	25 62826 8  8 x 1"	9	25 62841 10  10 x 1/2"	25 62843 11  10 x 3/4"	25 62845 12  10 x 1"		
10 62846 13  10 x 1-1/4"	10 62847 14  10 x 1-1/2"	15	25 62862 16  12 x 3/4"	10 62864 17  12 x 1"	10 62865 18  12 x 1-1/4"		
10 62866 19  12 x 1-1/2"	20	10 62882 21  14 x 3/4"	10 62884 22  14 x 1"	10 62885 23  14 x 1-1/4"	10 62886 24  14 x 1-1/2"		

CD - 251 Stainless Steel Slotted Pan Head
Sheet Metal Screws
99902 24 Space Tray



















CHOICE DISTRIBUTION		CD-251 Stainless Steel Slotted Binding Head Sheet Metal Screws				111 BELL STREET W. BABYLON, NY 11704 (516) 756-0120	
25 67811 ¹  6 x 3/8"	25 67812 ²  6 x 1/2"	25 67814 ³  6 x 3/4"	25 67816 ⁴  6 x 1"	25 67821 ⁵  8 x 3/8"	25 67822 ⁶  8 x 1/2"		
25 67824 ⁷  8 x 3/4"	25 67826 ⁸  8 x 1"		25 67841 ¹⁰  10 x 1/2"	25 67843 ¹¹  10 x 3/4"	25 67845 ¹²  10 x 1"		
10 67846 ¹³  10 x 1-1/4"	10 67847 ¹⁴  10 x 1-1/2"		25 67862 ¹⁶  12 x 3/4"	10 67864 ¹⁷  12 x 1"	10 67865 ¹⁸  12 x 1-1/4"		
10 67866 ¹⁹  12 x 1-1/2"		10 67882 ²¹  14 x 3/4"	10 67884 ²²  14 x 1"	10 67885 ²³  14 x 1-1/4"	10 67886 ²⁴  14 x 1-1/2"		

CD - 252 Stainless Steel Slotted
 Oval Head Sheet Metal Screws
 99937 20 Space Tray
 99936 Outside Shell





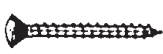



















CHOICE DISTRIBUTION		CD-252 Stainless Steel Slotted Oval head Sheet Metal Screws		111 BELL STREET W. BABYLON, NY 11704 (516) 756-0120	
25	67941	10	67985	5	67968
No. 10 X 1/2"		No. 14 X 1 1/4"		No. 12 x 2"	
25	67962	25	67964	10	67966
No. 12 x 3/4"		No. 12 x 1"		No. 12 x 1 1/2"	
25	67943	10	67947	5	67968
No. 10 x 3/4"		No. 10 x 1 1/2"		No. 12 x 2"	
25	67945	10	67949	10	67949
No. 10 x 1"		No. 10 x 2"		No. 10 x 2"	
25	67922	25	67924	10	67926
No. 8 x 1/2"		No. 8 x 3/4"		No. 8 x 1"	
25	67914	10	67928	5	67912
No. 6 x 3/4"		No. 8 x 1 1/2"		No. 6 X 1/2"	
25	67916	10	67946	10	67946
No. 6 x 1"		No. 10 X 1 1/4"		No. 10 X 1 1/4"	

CD - 253 Stainless Steel Phillips
 Oval Head Sheet Metal Screws
 99937 20 Space Tray
 99936 Outside Shell

























CHOICE
CHOICE
 DISTRIBUTION INC.
www.choice-distribution.com

CHOICE DISTRIBUTION		CD-253 Stainless Steel Phillips Oval Head Sheet Metal Screws		111 BELL STREET W. BABYLON, NY 11704 (516) 756-0120											
25	62941	1		25	62942	2		10	62985	3		5	62968	4	
25	62962	5		25	62964	6		10	62966	7		5	62968	8	
25	62943	9		25	62945	10		10	62947	11		10	62949	12	
25	62922	13		25	62924	14		25	62926	15		10	62928	16	
25	62914	17		25	62916	18		25	62912	19		10	62946	20	





















CD - 255 Stainless Steel Phillips
 Pan Head Machine Screws
 99902 24 Space Tray
 25 each

CHOICE DISTRIBUTION		CD-255 Stainless Steel Phillips Pan Head Machine Screws				111 BELL STREET W. BABYLON, NY 11704 (516) 756-0120	
<p>63147 ¹</p>  <p>10-24 x 1 1/4" UNC (USS)</p>	<p>63148 ²</p>  <p>10-24 x 1 1/2" UNC (USS)</p>	<p>63161 ³</p>  <p>10-32 x 1/2" UNF (SAE)</p>	<p>63163 ⁴</p>  <p>10-32 x 3/4" UNF (SAE)</p>	<p>63165 ⁵</p>  <p>10-32 x 1" UNF (SAE)</p>	<p>63195 ⁶</p>  <p>1/4"-20 x 1" UNC (USS)</p>		
<p>63125 ⁷</p>  <p>8-32 x 3/4" UNC (USS)</p>	<p>63127 ⁸</p>  <p>8-32 x 1" UNC (USS)</p>	<p>63142 ⁹</p>  <p>10-24 x 1/2" UNC (USS)</p>	<p>63144 ¹⁰</p>  <p>10-24 x 3/4" UNC (USS)</p>	<p>63146 ¹¹</p>  <p>10-24 x 1" UNC (USS)</p>	<p>63193 ¹²</p>  <p>1/4"-20 x 3/4" UNC (USS)</p>		
<p>63110 ¹³</p>  <p>6-32 x 1/4" UNC (USS)</p>	<p>63112 ¹⁴</p>  <p>6-32 x 1/2" UNC (USS)</p>	<p>63114 ¹⁵</p>  <p>6-32 x 3/4" UNC (USS)</p>	<p>63116 ¹⁶</p>  <p>6-32 x 1" UNC (USS)</p>	<p>63123 ¹⁷</p>  <p>8-32 x 1/2" UNC (USS)</p>	<p>63194 ¹⁸</p>  <p>1/4"-20 x 1/2" UNC (USS)</p>		
<p>63009 ¹⁹</p>  <p>6-32 UNC (USS) HEX NUT</p>	<p>63011 ²⁰</p>  <p>8-32 UNC (USS) HEX NUT</p>	<p>63012 ²¹</p>  <p>10-24 UNC (USS) HEX NUT</p>	<p>63014 ²²</p>  <p>10-32 UNF (SAE) HEX NUT</p>	<p>63018 ²³</p>  <p>1/4"-20 UNC (USS) HEX NUT</p>	<p>63019 ²⁴</p>  <p>1/4"-20 UNC (USS) HEX NUT</p>		

























CD - 256 Stainless Steel Slotted
Pan Head Machine Screws
99902 24 Space Tray
25 each







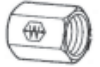
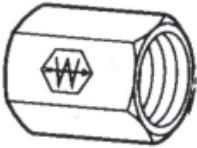

CHOICE DISTRIBUTION		CD-256 Stainless Steel Slotted Pan Head Machine Screws				111 BELL STREET W. BABYLON, NY 11704 (516) 756-0120	
<p>62147 ¹</p>  <p>10-24 x 1 1/4" UNC (USS)</p>	<p>62148 ²</p>  <p>10-24 x 1" UNC (USS)</p>	<p>62161 ³</p>  <p>10-32 x 1/2" UNF (SAE)</p>	<p>62163 ⁴</p>  <p>10-32 x 3/4" UNF (SAE)</p>	<p>62165 ⁵</p>  <p>10-32 x 1" UNF (SAE)</p>	<p>62195 ⁶</p>  <p>1/4"-20 x 1" UNC (USS)</p>		
<p>62125 ⁷</p>  <p>8-32 x 3/4" UNC (USS)</p>	<p>62127 ⁸</p>  <p>8-32 x 1" UNC (USS)</p>	<p>62142 ⁹</p>  <p>10-24 x 1/2" UNC (USS)</p>	<p>62144 ¹⁰</p>  <p>10-24 x 3/4" UNC (USS)</p>	<p>62146 ¹¹</p>  <p>10-24 x 1" UNC (USS)</p>	<p>62193 ¹²</p>  <p>1/4"-20 x 3/4" UNC (USS)</p>		
<p>62110 ¹³</p>  <p>6-32 x 1/4" UNC (USS)</p>	<p>62112 ¹⁴</p>  <p>6-32 x 1/2" UNC (USS)</p>	<p>62114 ¹⁵</p>  <p>6-32 x 3/4" UNC (USS)</p>	<p>62116 ¹⁶</p>  <p>6-32 x 1" UNC (USS)</p>	<p>62123 ¹⁷</p>  <p>8-32 x 1/2" UNC (USS)</p>	<p>62194 ¹⁸</p>  <p>1/4"-20 x 1/2" UNC (USS)</p>		
<p>63009 ¹⁹</p>  <p>6-32 UNC (USS) HEX NUT</p>	<p>63011 ²⁰</p>  <p>8-32 UNC (USS) HEX NUT</p>	<p>63012 ²¹</p>  <p>10-24 UNC (USS) HEX NUT</p>	<p>63014 ²²</p>  <p>10-32 UNF (SAE) HEX NUT</p>	<p>63018 ²³</p>  <p>1/4"-20 UNC (USS) HEX NUT</p>	<p>63019 ²⁴</p>  <p>1/4"-20 UNC (USS) HEX NUT</p>		

CD - 257 Stainless Steel
 Round Head Machine Screws
 99902 24 Space Tray
 25 each

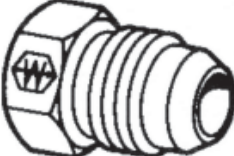
CHOICE DISTRIBUTION		CD-257 Stainless Steel Phillips Round Head Machine Screws				111 BELL STREET W. BABYLON, NY 11704 (516) 756-0120	
<p>63347¹</p>  <p>10-24 x 1 1/4" UNC (USS)</p>	<p>63361³</p>  <p>10-32 x 1/2" UNF (SAE)</p>	<p>63363⁴</p>  <p>10-32 x 3/4" UNF (SAE)</p>	<p>63365⁵</p>  <p>10-32 x 1" UNF (SAE)</p>	<p>63395⁶</p>  <p>1/4"-20 x 1" UNC (USS)</p>			
<p>63325⁷</p>  <p>8-32 x 3/4" UNC (USS)</p>	<p>63327⁸</p>  <p>8-32 x 1" UNC (USS)</p>	<p>63342⁹</p>  <p>10-24 x 1/2" UNC (USS)</p>	<p>63344¹⁰</p>  <p>10-24 x 3/4" UNC (USS)</p>	<p>63346¹¹</p>  <p>10-24 x 1" UNC (USS)</p>	<p>63393¹²</p>  <p>1/4"-20 x 3/4" UNC (USS)</p>		
<p>63310¹³</p>  <p>6-32 x 1/4" UNC (USS)</p>	<p>63312¹⁴</p>  <p>6-32 x 1/2" UNC (USS)</p>	<p>63314¹⁵</p>  <p>6-32 x 3/4" UNC (USS)</p>	<p>63323¹⁷</p>  <p>8-32 x 1/2" UNC (USS)</p>				
<p>63009¹⁹</p>  <p>6-32 UNC (USS) HEX NUT</p>	<p>63011²⁰</p>  <p>8-32 UNC (USS) HEX NUT</p>	<p>63012²¹</p>  <p>10-24 UNC (USS) HEX NUT</p>	<p>63014²²</p>  <p>10-32 UNF (SAE) HEX NUT</p>	<p>63018²³</p>  <p>1/4"-20 UNC (USS) HEX NUT</p>			

CD - 258 Stainless Steel Phillips
Phillips Flat Head Machine Screws
99902 24 Space Tray

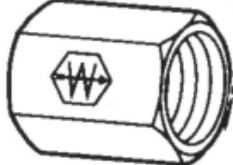
CHOICE DISTRIBUTION		CD-258 Stainless Steel Phillips Flat Head Machine Screws				111 BELL STREET W. BABYLON, NY 11704 (516) 756-0120	
<p>63009¹</p> <p>25 </p> <p>6-32 Hex Nut</p>	<p>63011²</p> <p>25 </p> <p>8-32 Hex Nut</p>	<p>63012³</p> <p>25 </p> <p>10-24 Hex Nut</p>	<p>63014⁴</p> <p>25 </p> <p>10-32 Hex Nut</p>	<p>63018⁵</p> <p>25 </p> <p>1/4-20 Hex Nut</p>	<p>65193⁶</p> <p>25 </p> <p>1/4-20-3/4</p>		
<p>65112⁷</p> <p>25 </p> <p>6-32-1/2</p>	<p>65114⁸</p> <p>25 </p> <p>6-32-3/4</p>	<p>65116⁹</p> <p>25 </p> <p>6-32-1</p>	<p>65123¹⁰</p> <p>25 </p> <p>8-32-1/2</p>	<p>65125¹¹</p> <p>25 </p> <p>8-32-3/4</p>	<p>65195¹²</p> <p>25 </p> <p>1/4-20-1</p>		
<p>65127¹³</p> <p>25 </p> <p>8-32-1</p>	<p>65128¹⁴</p> <p>25 </p> <p>8-32-1-1/4</p>	<p>65161¹⁵</p> <p>25 </p> <p>10-32-1/2</p>	<p>65163¹⁶</p> <p>25 </p> <p>10-32-3/4</p>	<p>65165¹⁷</p> <p>25 </p> <p>10-32-1</p>	<p>65196¹⁸</p> <p>10 </p> <p>1/4-20-1-1/4</p>		
<p>65166¹⁹</p> <p>25 </p> <p>10-32-1-1/4</p>	<p>65142²⁰</p> <p>25 </p> <p>10-24-1/2</p>	<p>65144²¹</p> <p>25 </p> <p>10-24-3/4</p>	<p>65146²²</p> <p>25 </p> <p>10-24-1</p>	<p>65147²³</p> <p>25 </p> <p>10-24-1-1/4</p>	<p>65197²⁴</p> <p>10 </p> <p>1/4-20-1-1/2</p>		

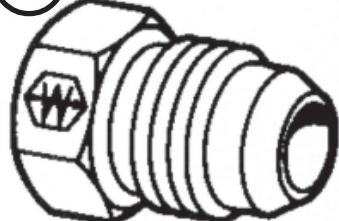
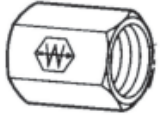
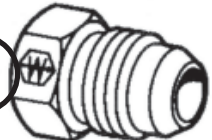
CHOICE DISTRIBUTION		CD-270 JIC Plugs & Caps		111 BELL STREET W. BABYLON, NY 11704 (516) 756-0120			
5	 96107 1/4 JIC Cap	2	 96112 3/4 JIC Cap	5	 96151 1/4 JIC Plug	2	 96156 3/4 JIC Plug
5	 96108 5/16 JIC Cap			5	 96152 5/16 JIC Plug		
5	 96109 3/8 JIC Cap	2	 96114 1" JIC Cap	5	 96153 3/8 JIC Plug	2	 96158 1" JIC Plug
5	 96110 1/2 JIC Cap			5	 96154 1/2 JIC Plug		

DRILL SIZE	CHOICE PART No.	UNIT
1/16	55400	4
5/64	55401	4
3/32	55402	4
7/64	55403	4
1/8	55404	4
9/64	55405	3
5/32	55406	3
11/64	55407	3
3/16	55408	3
13/64	55409	2
7/32	55410	2
15/64	55411	2
1/4	55412	2
17/64	55413	1
9/32	55414	1
19/64	55415	1
5/16	55416	1
21/64	55417	1
11/32	55418	1
23/64	55419	1
3/8	55420	1
25/64	55421	1
13/32	55422	1
27/64	55423	1
7/16	55424	1
29/64	55425	1
15/32	55426	1
31/64	55427	1
1/2	55428	1

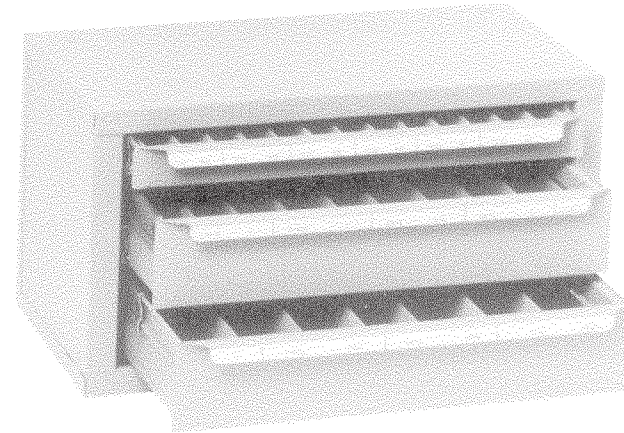

CD - 294

(C82500)

SUPER PRIMALLOY DRILLS
MAGNUM 135' SPLIT POINT
 FRACTIONAL DRILLS SIZES 1/16" TO 1/2" BY 64THS
 IN A 99914 DRILL CABINET

DRILL SIZE	CHOICE PART No.	UNIT
1/16	55400	1
5/64	55401	1
3/32	55402	1
7/64	55403	1
1/8	55404	1
9/64	55405	1
5/32	55406	1
11/64	55407	1
3/16	55408	1
13/64	55409	1
7/32	55410	1
15/64	55411	1
1/4	55412	1
17/64	55413	1
9/32	55414	1
19/64	55415	1
5/16	55416	1
21/64	55417	1
11/32	55418	1
23/64	55419	1
3/8	55420	1
25/64	55421	1
13/32	55422	1
27/64	55423	1
7/16	55424	1
29/64	55425	1
15/32	55426	1
31/64	55427	1
1/2	55428	1

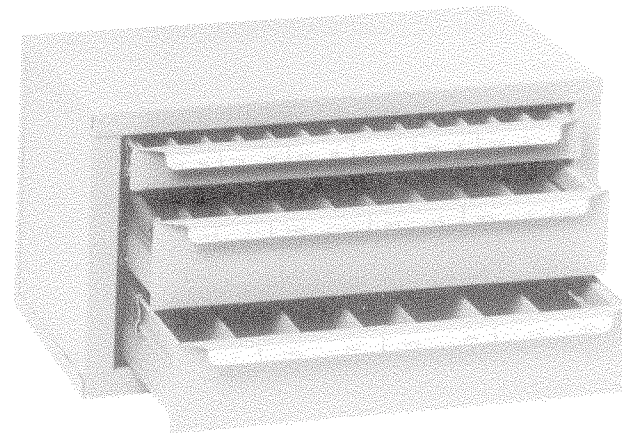

CD - 295

**FRACTIONAL SIZE DRILL BITS
 MAGNUM 135' SPLIT POINT**

**FRACTIONAL DRILLS SIZES 1/16" TO 1/2" BY 64THS
 IN A 99914 DRILL CABINET**

ONE EACH SIZE

DRILL SIZE	CHOICE PART No.	UNIT
1/16	55400	1
5/64	55401	1
3/32	55402	1
7/64	55403	1
1/8	55404	1
9/64	55405	1
5/32	55406	1
11/64	55407	1
3/16	55408	1
13/64	55409	1
7/32	55410	1
15/64	55411	1
1/4	55412	1
17/64	55413	1
9/32	55414	1
19/64	55415	1
5/16	55416	1
21/64	55417	1
11/32	55418	1
23/64	55419	1
3/8	55420	1
25/64	55421	1
13/32	55422	1
27/64	55423	1
7/16	55424	1
29/64	55425	1
15/32	55426	1
31/64	55427	1
1/2	55428	1

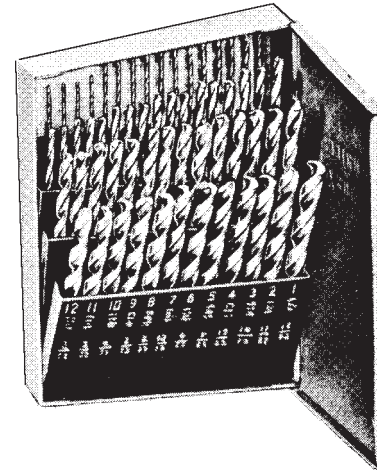

MECHANICS LENGTH
CD - 296
29 DRILLS SIZES 1/16" to 1/2"
by 64ths
IN A 99975 INDEX
ONE EACH SIZE

DRILL SIZE	CHOICE PART No.	UNIT
1/16	55400	1
3/32	55402	1
1/8	55404	1
5/32	55406	1
3/16	55408	1
7/32	55410	1
1/4	55412	1
9/32	55414	1
5/16	55416	1
11/32	55418	1
3/8	55420	1
13/32	55422	1
7/16	55424	1
15/32	55426	1
1/2	55428	1

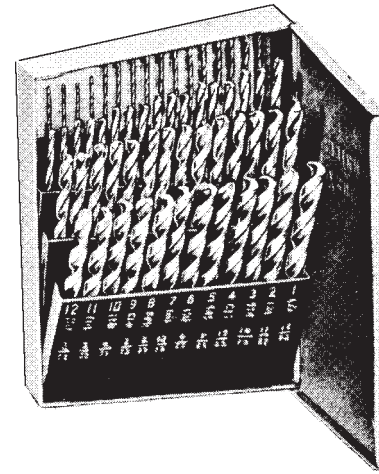

**MAGNUM 135 ' SPLIT POINT
 FRACTIONAL SIZE DRILL BITS
 CD - 297**

15 DRILLS SIZES





1/16" to 1/2"

by 32nds

IN A 99976 INDEX

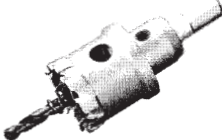
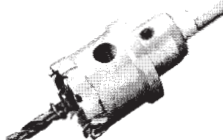
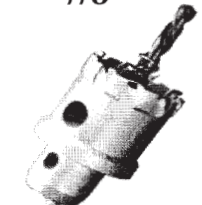
ONE EACH SIZE

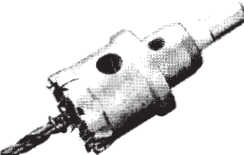
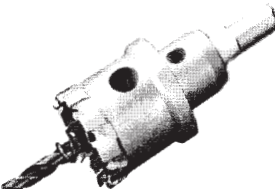
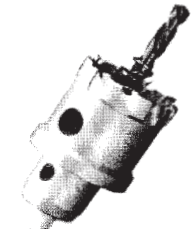
CD - 298 Choice Kut
 Small Carbide Tipped Hole Saws
 99905 Adjustable Space Tray







CHOICE DISTRIBUTION	CD-298 CHOICE KUT Small Carbide Tipped Hole Saws			111 BELL STREET W. BABYLON, NY 11704 (631) 756-0120
	<p>①</p> <p>5/8"</p>  <p>124683</p>	<p>①</p> <p>3/4"</p>  <p>124687</p>	<p>①</p> <p>7/8"</p>  <p>124691</p>	
<p>①</p> <p>Screw</p>  <p>124724</p>				
<p>①</p> <p>Spring</p>  <p>124726</p>	<p>①</p> <p>11/16"</p>  <p>124685</p>	<p>①</p> <p>13/16"</p>  <p>124689</p>	<p>①</p> <p>15/16"</p>  <p>124693</p>	
<p>Carbide Pilot Drill</p>  <p>①</p> <p>127041</p>				

CD - 299 ChoiceKut
 Large Carbide Tipped Hole Saws
 99905 Adjustable Space Tray

**CHOICE
 DISTRIBUTION**

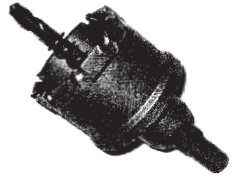
CD-299 CHOICE KUT Large Carbide Tipped Hole Saws

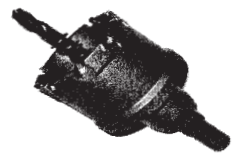
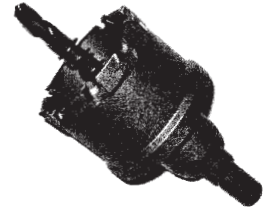
111 BELL STREET
 W. BABYLON, NY 11704
 (631) 756-0120

	<p>(1)</p> <p>1"</p>  <p>124695</p>	<p>(1)</p> <p>1-1/8"</p>  <p>124699</p>	<p>(1)</p> <p>1-3/4"</p>  <p>124713</p>
<p>(1) 124724 Screw</p> 	<p>(1)</p> <p>1-1/16"</p>  <p>124697</p>	<p>(1)</p> <p>1-3/8"</p>  <p>124705</p>	<p>(1)</p> <p>2"</p>  <p>124718</p>
<p>(1) Spring</p>  <p>124726</p>			
<p>Carbide Pilot Drill</p>  <p>(1) 127041</p>			

DRILL SIZE	CHOICE PART No.	UNIT
1/16	22100	1
5/64	22101	1
3/32	22102	1
7/64	22103	1
1/8	22104	1
9/64	22105	1
5/32	22106	1
11/64	22107	1
3/16	22108	1
13/64	22109	1
7/32	22110	1
15/64	22111	1
1/4	22112	1
17/64	22113	1
9/32	22114	1
19/64	22115	1
5/16	22116	1
21/64	22117	1
11/32	22118	1
23/64	22119	1
3/8	22120	1
25/64	22121	1
13/32	22122	1
27/64	22123	1
7/16	22124	1
29/64	22125	1
15/32	22126	1
31/64	22127	1
1/2	22128	1

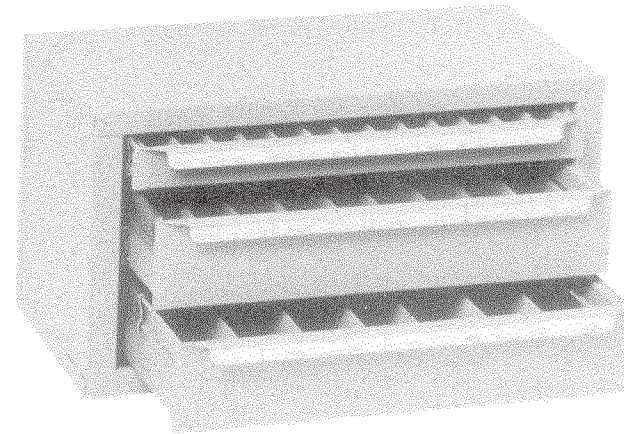

CD - 300
FRACTIONAL SIZE DRILL BITS
MAGNUM 135' SPLIT POINT
FRACTIONAL DRILLS SIZES 1/16" TO 1/2" BY 64THS
IN A 99914 DRILL CABINET
ONE EACH SIZE

LETTER SIZE	CHOICE PART No.	UNIT
A	22201	1
B	22202	1
C	22203	1
D	22204	1
E	22205	1
F	22206	1
G	22207	1
H	22208	1
I	22209	1
J	22210	1
K	22211	1
L	22212	1
M	22213	1
N	22214	1
O	22215	1
P	22216	1
Q	22217	1
R	22218	1
S	22219	1
T	22220	1
U	22221	1
V	22222	1
W	22223	1
X	22224	1
Y	22225	1
Z	22226	1

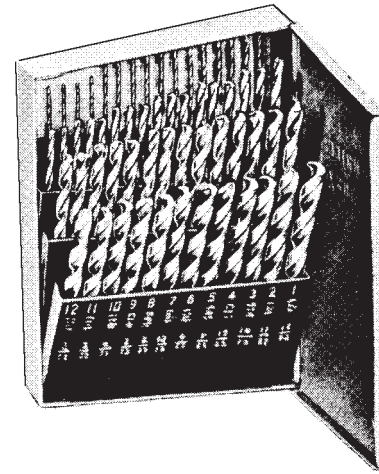

**MAGNUM 135 ' SPLIT POINT
 LETTER SIZE DRILL BITS**

CD - 301

26 DRILLS SIZES

A to Z

IN A 99919 INDEX

ONE EACH SIZE

DRILL SIZE	CHOICE PART No.	UNIT
1	22301	1
2	22302	1
3	22303	1
4	22304	1
5	22305	1
6	22306	1
7	22307	1
8	22308	1
9	22309	1
10	22310	1
11	22311	1
12	22312	1
13	22313	1
14	22314	1
15	22315	1
16	22316	1
17	22317	1
18	22318	1
19	22319	1
20	22320	1
21	22321	1
22	22322	1
23	22323	1
24	22324	1
25	22325	1
26	22326	1
27	22327	1
28	22328	1
29	22329	1
30	22330	1

DRILL SIZE	CHOICE PART No.	UNIT
31	22331	1
32	22332	1
33	22333	1
34	22334	1
35	22335	1
36	22336	1
37	22337	1
38	22338	1
39	22339	1
40	22340	1
41	22341	1
42	22342	1
43	22343	1
44	22344	1
45	22345	1
46	22346	1
47	22347	1
48	22348	1
49	22349	1
50	22350	1
51	22351	1
52	22352	1
53	22353	1
54	22354	1
55	22355	1
56	22356	1
57	22357	1
58	22358	1
59	22359	1
60	22360	1

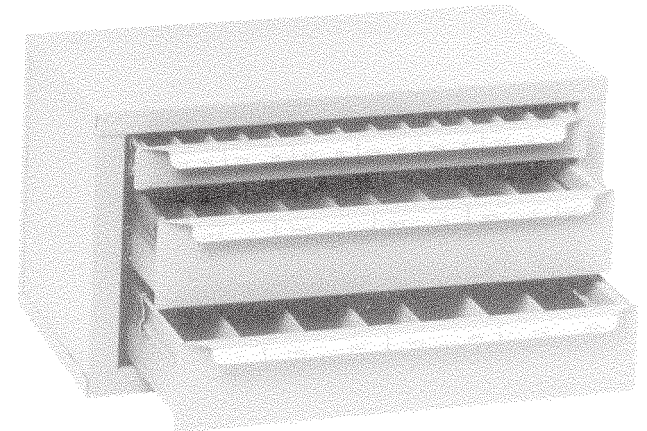

CD - 302

**NUMBER SIZE DRILL BITS
 MAGNUM 135' SPLIT POINT
 NUMBER DRILL SIZES 1 - 60
 IN A 99915 DRILL CABINET**

ONE EACH SIZE

LETTER SIZE	CHOICE PART No.	UNIT
A	22201	1
B	22202	1
C	22203	1
D	22204	1
E	22205	1
F	22206	1
G	22207	1
H	22208	1
I	22209	1
J	22210	1
K	22211	1
L	22212	1
M	22213	1
N	22214	1
O	22215	1
P	22216	1
Q	22217	1
R	22218	1
S	22219	1
T	22220	1
U	22221	1
V	22222	1
W	22223	1
X	22224	1
Y	22225	1
Z	22226	1

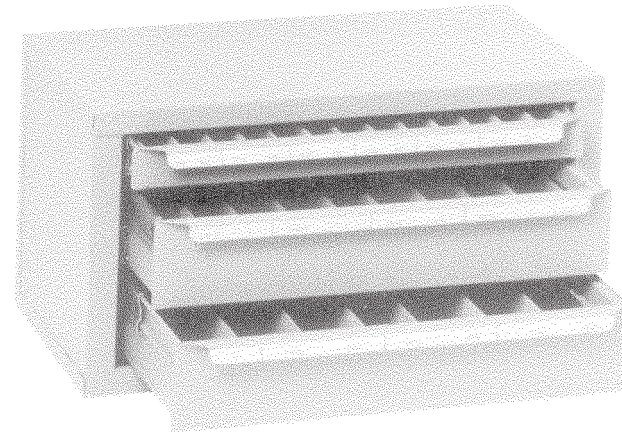

CD - 303

**LETTER SIZE DRILL BITS
 MAGNUM 135' SPLIT POINT
 LETTER DRILL SIZES A - Z
 IN A 99916 DRILL CABINET**

ONE EACH SIZE

DRILL SIZE	CHOICE PART No.	UNIT
1/16	22100	1
5/64	22101	1
3/32	22102	1
7/64	22103	1
1/8	22104	1
9/64	22105	1
5/32	22106	1
11/64	22107	1
3/16	22108	1
13/64	22109	1
7/32	22110	1
15/64	22111	1
1/4	22112	1
17/64	22113	1
9/32	22114	1
19/64	22115	1
5/16	22116	1
21/64	22117	1
11/32	22118	1
23/64	22119	1
3/8	22120	1
25/64	22121	1
13/32	22122	1
27/64	22123	1
7/16	22124	1
29/64	22125	1
15/32	22126	1
31/64	22127	1
1/2	22128	1

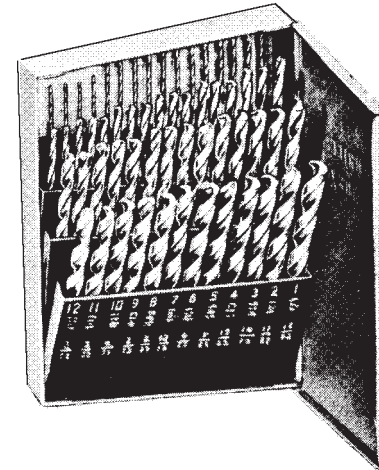

MAGNUM 135 ' SPLIT POINT FRACTIONAL SIZE DRILL BITS

CD - 304

29 DRILLS SIZES

1/16" to 1/2"

by 64ths

IN A 99917 INDEX

ONE EACH SIZE

DRILL SIZE	CHOICE PART No.	UNIT
1/16	22100	1
3/32	22102	1
1/8	22104	1
5/32	22106	1
3/16	22108	1
7/32	22110	1
1/4	22112	1
9/32	22114	1
5/16	22116	1
11/32	22118	1
3/8	22120	1
13/32	22122	1
7/16	22124	1
15/32	22126	1
1/2	22128	1

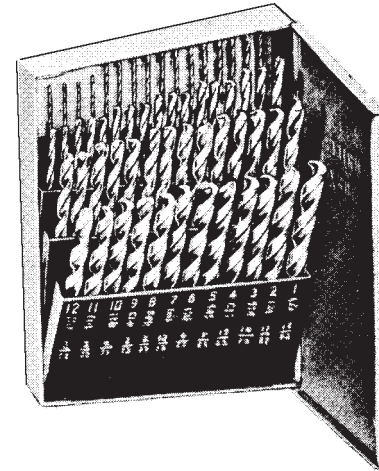

**MAGNUM 135 ' SPLIT POINT
 FRACTIONAL SIZE DRILL BITS**

CD - 305

15 DRILLS SIZES

1/16" to 1/2"

by 32nds

IN A 99946 INDEX

ONE EACH SIZE

DRILL SIZE	CHOICE PART No.	UNIT
1	22301	1
2	22302	1
3	22303	1
4	22304	1
5	22305	1
6	22306	1
7	22307	1
8	22308	1
9	22309	1
10	22310	1
11	22311	1
12	22312	1
13	22313	1
14	22314	1
15	22315	1
16	22316	1
17	22317	1
18	22318	1
19	22319	1
20	22320	1
21	22321	1
22	22322	1
23	22323	1
24	22324	1
25	22325	1
26	22326	1
27	22327	1
28	22328	1
29	22329	1
30	22330	1

DRILL SIZE	CHOICE PART No.	UNIT
31	22331	1
32	22332	1
33	22333	1
34	22334	1
35	22335	1
36	22336	1
37	22337	1
38	22338	1
39	22339	1
40	22340	1
41	22341	1
42	22342	1
43	22343	1
44	22344	1
45	22345	1
46	22346	1
47	22347	1
48	22348	1
49	22349	1
50	22350	1
51	22351	1
52	22352	1
53	22353	1
54	22354	1
55	22355	1
56	22356	1
57	22357	1
58	22358	1
59	22359	1
60	22360	1

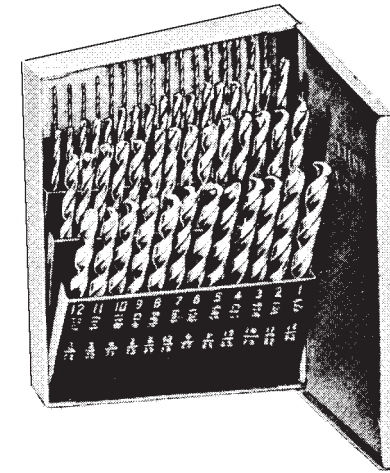

**MAGNUM 135 ' SPLIT POINT
 NUMBER SIZE DRILL BITS**

CD - 306

60 DRILLS SIZES

1 to 60

IN A 99918 INDEX

ONE EACH SIZE

MAGNUM SILVER & DEMING DRILLS

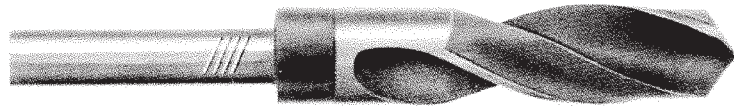

CD - 307

MAGNUM SILVER & DEMING DRILL BITS

8 DRILLS 1/2" TO 1" BY 16ths

IN A 99944 STAND-UP TYPE STAND

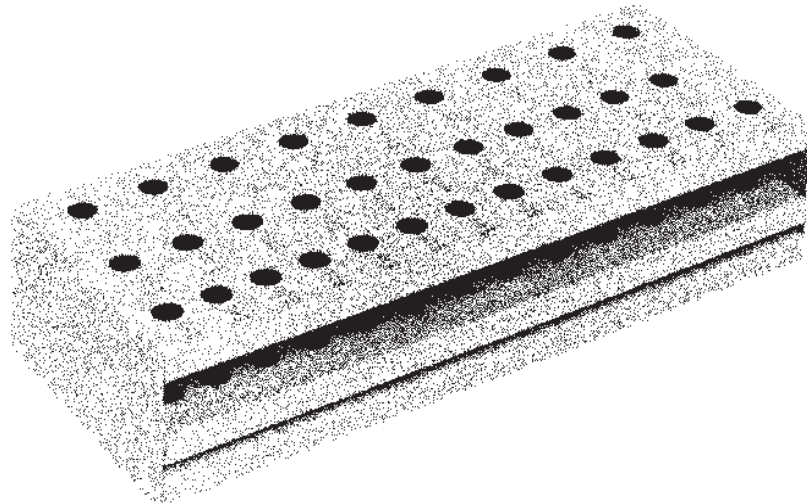

99944 (1)

SILVER & DEMING DRILL BIT

STAND-UP TYPE STAND

DRILL SIZE	CHOICE PART No.	UNIT
9/16	22131	1
5/8	22133	1
11/16	22135	1
3/4	22138	1
13/16	22140	1
7/8	22143	1
15/16	22145	1
1	22147	1

MAGNUM SILVER & DEMING DRILLS

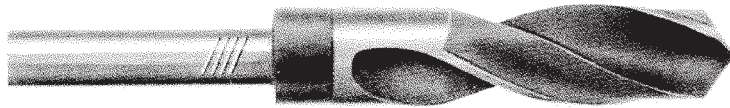

CD - 308
MAGNUM SILVER & DEMING DRILL
BITS
 16 DRILLS 17/32" TO 1" BY 32nds
 IN A 99944 STAND-UP TYPE STAND

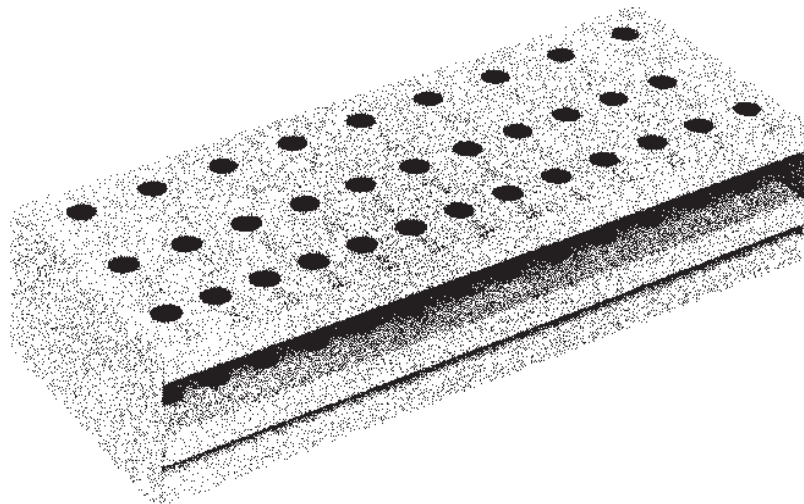

99944 (1)
SILVER & DEMING DRILL BIT
STAND-UP TYPE STAND

DRILL SIZE	CHOICE PART No.	UNIT
17/32	22130	1
9/16	22131	1
19/32	22132	1
5/8	22133	1
21/32	22134	1
11/16	22135	1
23/32	22137	1
3/4	22138	1
25/32	22139	1
13/16	22140	1
27/32	22141	1
7/8	22143	1
29/32	22144	1
15/16	22145	1
31/32	22146	1
1	22147	1

Dia.	PLUG TAP	UNIT
6-32	23503	1
8-32	23505	1
10-24	23507	1
10-32	23508	1
1/4-20	23510	1
1/4-28	23511	1
5/16-18	23512	1
5/16-24	23513	1
3/8-16	23514	1
3/8-24	23515	1
7/16-14	23516	1
7/16-20	23517	1
1/2-13	23518	1
1/2-20	23519	1
Dia.	DRILL	UNIT
#36	22336	1
#29	22329	1
#25	22325	1
#21	22321	1
#7	22307	1
#3	22303	1
F	22206	1
I	22209	1
5/16	22116	1
Q	22217	1
U	22221	1
25/64	22121	1
27/64	22123	1
29/64	22125	1

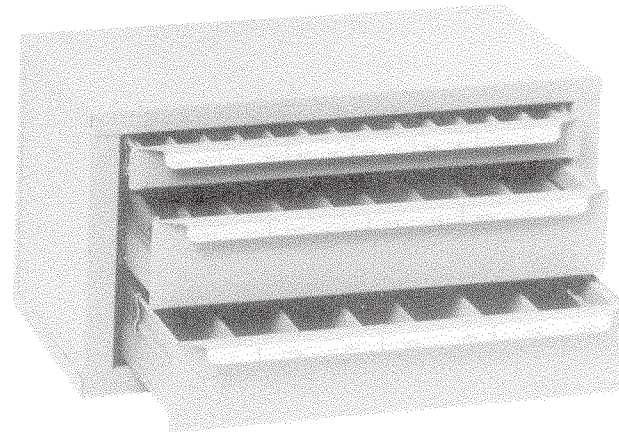







CD - 309

**ASSORTMENT CONTAINS CHOICE DISTRIBUTION
 MAGNUM 135' SPLIT POINT DRILL BITS
 AND
 SUPER -TOUGH HI-CARBON STEEL
 PLUG TAPS
 IN A 99945 TAP & DRILL COMBO CABINET**

CD - 310 Hole Saws
 99905 Adjustable Space Tray
 1 each

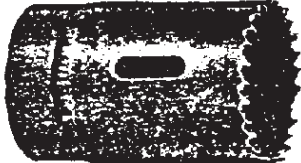
CHOICE
CHOICE
 DISTRIBUTION INC.
www.choice-distribution.com

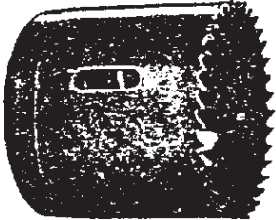
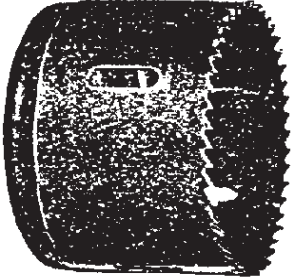
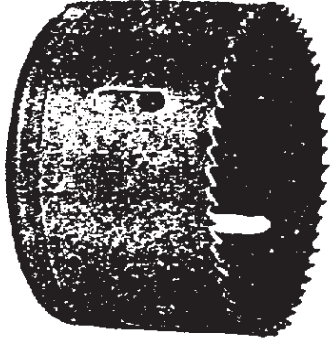
CHOICE DISTRIBUTION			CD-310	Hole saws	111 BELL STREET W. BABYLON, NY 11704 (516) 756-0120	
23803			23804		23805	
						
9/16" Dia.			3/4" Dia.		7/8" Dia.	
23800			23807		23810	
23802						
23801			1 1/8" Dia.		1 1/2" Dia.	
			23812		23813	
						
Arbor 1/2-20			2" Dia.		2 1/2" Dia.	
23804			23814			
23805			3" Dia.			
23806						
23807						
23808						
23809						
23810						
23811						
23812						
23813						
23814						
23815						
23816						
23817						
23818						
23819						
23820						
23821						
23822						
23823						
23824						
23825						
23826						
23827						
23828						
23829						
23830						
23831						
23832						
23833						
23834						
23835						
23836						
23837						
23838						
23839						
23840						
23841						
23842						
23843						
23844						
23845						
23846						
23847						
23848						
23849						
23850						
23851						
23852						
23853						
23854						
23855						
23856						
23857						
23858						
23859						
23860						
23861						
23862						
23863						
23864						
23865						
23866						
23867						
23868						
23869						
23870						
23871						
23872						
23873						
23874						
23875						
23876						
23877						
23878						
23879						
23880						
23881						
23882						
23883						
23884						
23885						
23886						
23887						
23888						
23889						
23890						
23891						
23892						
23893						
23894						
23895						
23896						
23897						
23898						
23899						
23900						
23901						
23902						
23903						
23904						
23905						
23906						
23907						
23908						
23909						
23910						
23911						
23912						
23913						
23914						
23915						
23916						
23917						
23918						
23919						
23920						
23921						
23922						
23923						
23924						
23925						
23926						
23927						
23928						
23929						
23930						
23931						
23932						
23933						
23934						
23935						
23936						
23937						
23938						
23939						
23940						
23941						
23942						
23943						
23944						
23945						
23946						
23947						
23948						
23949						
23950						
23951						
23952						
23953						
23954						
23955						
23956						
23957						
23958						
23959						
23960						
23961						
23962						
23963						
23964						
23965						
23966						
23967						
23968						
23969						
23970						
23971						
23972						
23973						
23974						
23975						
23976						
23977						
23978						
23979						
23980						
23981						
23982						
23983						
23984						
23985						
23986						
23987						
23988						
23989						
23990						
23991						
23992						
23993						
23994						
23995						
23996						
23997						
23998						
23999						
24000						

CD - 311 Wire Brushes
99905 Adjustable Space Tray
1 each

CHOICE
CHOICE
DISTRIBUTION INC.
www.choice-distribution.com

CHOICE
DISTRIBUTION

CD-311 WIRE BRUSHES

111 BELL STREET
W. BABYLON, NY 11704
(516) 756-0120



7015
WIRE END BRUSH
TWISTED KNOT TYPE
3/4" Diameter
.014" Wire Size
20,000 Max. RPM



7011
WIRE END BRUSH
SOLID FILL TYPE
3/4" Diameter
.006" Wire Size
20,000 Max. RPM



7012
WIRE END BRUSH
SOLID FILL TYPE
3/4" Diameter
.014" Wire Size
20,000 Max. RPM



7016
WIRE END BRUSH
TWISTED KNOT TYPE
1" Diameter
.020" Wire Size
20,000 Max. RPM



7010
WIRE END BRUSH
SOLID FILL TYPE
1/2" Diameter
.006" Wire Size
25,000 Max. RPM



7013
WIRE END BRUSH
SOLID FILL TYPE
1" Diameter
.020" Wire Size
20,000 Max. RPM



6995
SMALL WIRE SCRATCH
BRUSH
3x7 STAINLESS STEEL

Dia.	PLUG TAP	UNIT
6-32	23503	1
8-32	23505	1
10-24	23507	1
10-32	23508	1
1/4-20	23510	1
5/16-18	23512	1
3/8-16	23514	1
7/16-14	23516	1
1/2-13	23518	1
Dia.	DRILL	UNIT
#36	22336	1
#29	22329	1
#25	22325	1
#21	22321	1
#7	22307	1
F	22206	1
5/16	22116	1
U	22221	1
27/64	22123	1

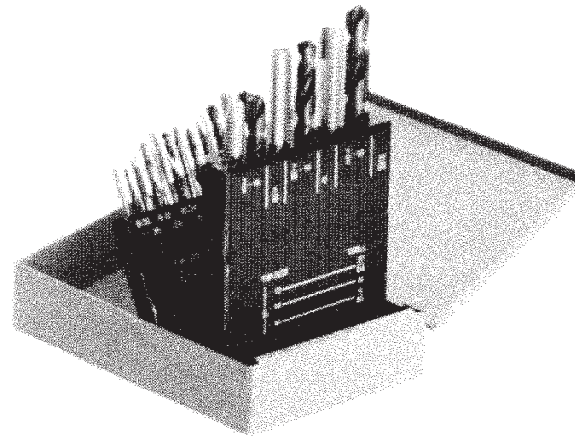

CD - 313

**NATIONAL COARSE (USS)
 TAP & DRILL COMBO ASSORTMENT
 SUPER-TOUGH HI-CARBON STEEL PLUG TAPS
 #6 TO 1/2
 WITH
 MATCHING MAGNUM 135' SPLIT POINT DRILL BITS
 IN A TAP/DRILL INDEX
 99947**

Dia.	PLUG TAP	UNIT
6-40	23504	1
8-36	23506	1
10-24	23507	1
10-32	23508	1
1/4-28	23511	1
5/16-24	23513	1
3/8-24	23515	1
7/16-20	23517	1
1/2-20	23519	1
Dia.	DRILL	UNIT
#33	22333	1
#29	22329	1
#25	22325	1
#21	22321	1
#3	22303	1
I	22209	1
Q	22217	1
25/64	22121	1
29/64	22125	1

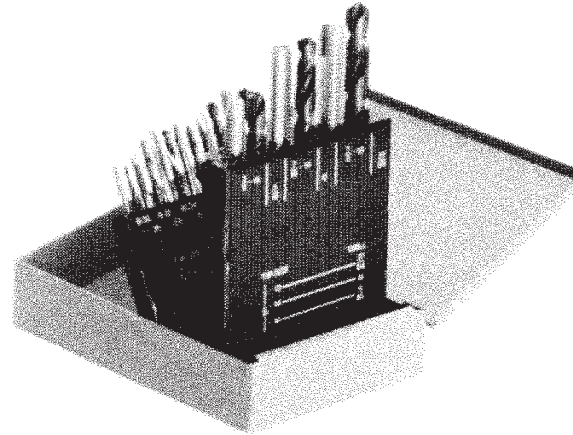

CD - 314

**NATIONAL FINE (SAE)
TAP & DRILL COMBO ASSORTMENT
SUPER-TOUGH HI-CARBON STEEL PLUG TAPS
#6 TO 1/2
WITH
MATCHING MAGNUM 135' SPLIT POINT DRILL
BITS
IN A TAP/DRILL INDEX
99948**

LEFT HAND DRILL SET

CD - 315

11 DRILLS 1/16" TO 1/2" BY 16^{THS}
 IN A 99934 INDEX



DRILL SIZE	CHOICE PART No.	UNIT
1/16	22050	2
3/32	22052	2
1/8	22054	2
5/32	22055	2
3/16	22056	2
7/32	22063	1
1/4	22057	1
5/16	22059	1
3/8	22060	1
7/16	22061	1
1/2	22062	1

CARBON STEEL TAP SET

CHOICE PREMIUM TAPS

CD-316

TAP SIZE	CHOICE PART No.
4/40	23601
6/32	23603
8/32	23605
10/24	23607
10/32	23608
1/4-20	23611
5/16-18	23613
3/8-16	23615
1/2-13	23619
5/8-11	23623

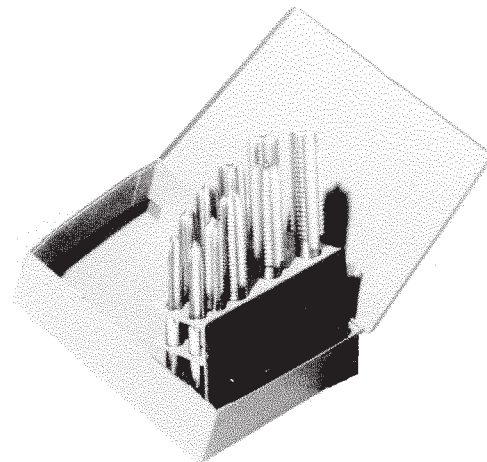

INCLUDES INDEX PART # 99966

ONE EACH

SILVER & DEMING DRILL SET

SUPER PREMIUM HIGH SPEED STEEL

135° Point, Reduced Shank

Black and Steel Finish

CD-317

DRILL SIZE	CHOICE PART No.
9/16	22131
5/8	22133
11/16	22135
3/4	22138
13/16	22140
7/8	22143
15/16	22145
1	22147

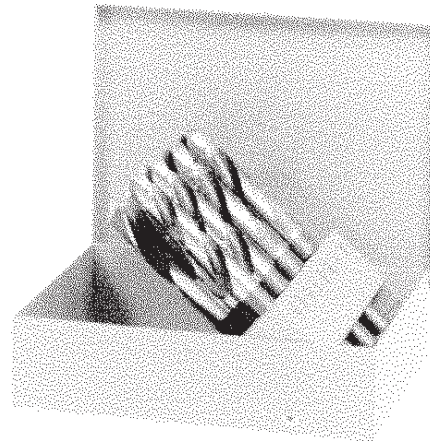

INCLUDES INDEX PART # 99967

ONE EACH

SPIRAL TAP SET

CHOICE SPIRAL TAPS

CD-318

TAP SIZE	CHOICE PART No.
6/32	23703
8/32	23705
10/24	23707
10/32	23708
1/4-20	23711
5/16-18	23713
3/8-16	23715
1/2-13	23719
5/8-11	23723

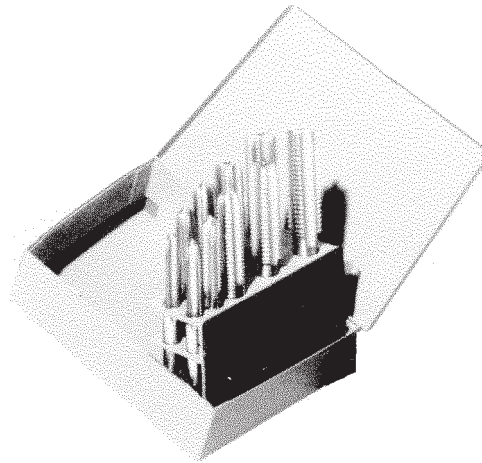

INCLUDES INDEX PART # 99966

ONE EACH

CD - 320 Bi-Metal Blades
 99906 Long Space Tray
 4 each

CHOICE
CHOICE
 DISTRIBUTION INC.
www.choice-distribution.com

CHOICE DISTRIBUTION	CD-320 Bi-Metal Blades		111 BELL STREET W. BABYLON, NY 11704 (516) 756-0120
25800	Length 6"	14 Teeth per inch	Metals over 1/8" thick
25801	Length 6"	18 Teeth per inch	Metals 1/8" thick or less
25802	Length 6"	24 Teeth per inch	Metals lighter than 18 gauge
25803	Length 4"	14 Teeth per inch	Metals over 1/8" thick
25804	Length 4"	18 Teeth per inch	Metals 1/8" thick or less
25805	Length 4"	24 Teeth per inch	Metals lighter than 18 gauge

**CHOICE
DISTRIBUTION**

CD-321 TT 44 Nail-Embedded Wood Blades

111 BELL STREET
W. BABYLON, NY 11704
(631) 756-0120

3

25811

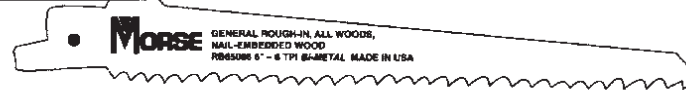

Length 6"

6 Teeth per inch

Standard work on nail-embedded wood

3

25807

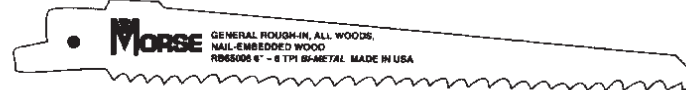

Length 12"

6 Teeth per inch

Standard work on nail-embedded wood

3

25808

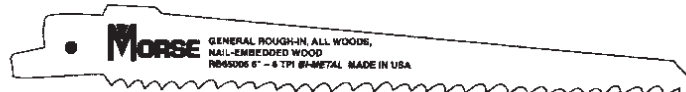

Length 12"

10/14 Teeth per inch

Standard work on nail-embedded wood

5

25823

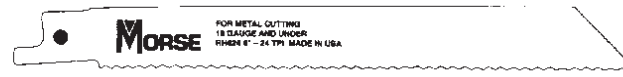

Length 6"

6 Teeth per inch

Roughing-in work on wood and composition board

5

25824

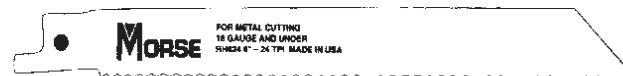

Length 6"

10 Teeth per inch

Standard work on nail-embedded wood

CD - 322 Combo Reciprocating Saw Blades
 & Saber Saw Blades
 99905 Adjustable Space Tray
 3 each

CHOICE
DISTRIBUTION

**CD-322 COMBO - RECIPROCATING SAW BLADES
 & SABER SAW BLAES**

111 BELL STREET
 W. BABYLON, NY 11704
 (631) 756-0120



25803
 length - 4"
 Teeth per inch - 14
BI-METAL
RECIPROCATING SAW BLADE
 Metals over 1/8" thick



25801
 length - 6"
 Teeth per inch - 18
BI-METAL
RECIPROCATING SAW BLADE
 Metals 1/8" thick or less



25811
 length - 6"
 Teeth per inch - 6
SPRING TEMPERED
RECIPROCATING SAW BLADE
 For contour wood cutting

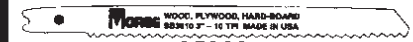

SABER SAW BLADES
25830
 length - 4"
 Teeth per inch - 14
 Ferrous metals 16 gauge to 10 gauge, Non-ferrous
 metals up to 1/4"

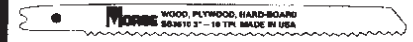

SABER SAW BLADES
25831
 length - 3"
 Teeth per inch - 18
 Metals 18 gauge to 12 gauge

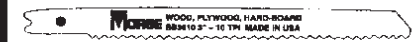

SABER SAW BLADES
25832
 length - 3"
 Teeth per inch - 24
 Metals lighter than 18 gauge

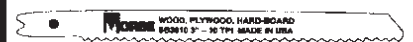

SABER SAW BLADES
25833
 length - 4"
 Teeth per inch - 6
 Roughing-in heavy wood

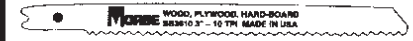

SABER SAW BLADES
25834
 length - 4"
 Teeth per inch - 10
 Use on lighter wood

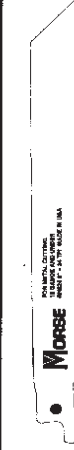

25824
 length - 6"
 Teeth per inch - 10
NAIL-EMBEDDED WOOD
RECIPROCATING SAW BLADE
 Standard work on nail-embedded wood



25812
 length - 6"
 Teeth per inch - 6
SPRING TEMPERED
RECIPROCATING SAW BLADE
 Roughing-in wood

DRILL SIZE	CHOICE PART No.	UNIT
1/16	41300	1
5/64	41301	1
3/32	41302	1
7/64	41303	1
1/8	41304	1
9/64	41305	1
5/32	41306	1
11/64	41307	1
3/16	41308	1
13/64	41309	1
7/32	41310	1
15/64	41311	1
1/4	41312	1
17/64	41313	1
9/32	41314	1
19/64	41315	1
5/16	41316	1
21/64	41317	1
11/32	41318	1
23/64	41319	1
3/8	41320	1
25/64	41321	1
13/32	41322	1
27/64	41323	1
7/16	41324	1
29/64	41325	1
15/32	41326	1
31/64	41327	1
1/2	41328	1

FRACTIONAL SIZE DRILL BITS
COBALT 135' SPLIT POINT
 SIZES 1/16" TO 1/2" BY 64THS
CD - 330

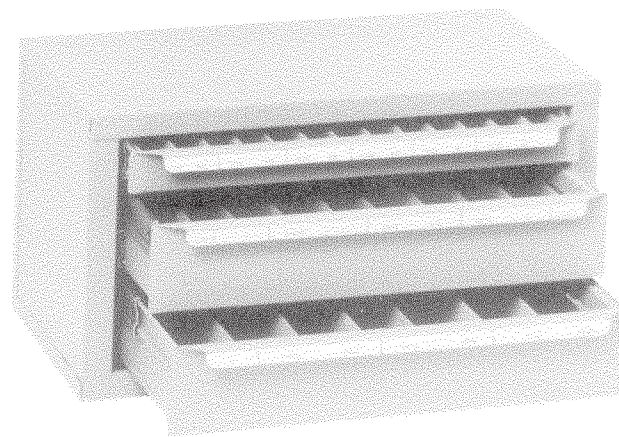

99914 DRILL CABINET

DRILL SIZE	CHOICE PART No.	UNIT
1/16	41300	1
5/64	41301	1
3/32	41302	1
7/64	41303	1
1/8	41304	1
9/64	41305	1
5/32	41306	1
11/64	41307	1
3/16	41308	1
13/64	41309	1
7/32	41310	1
15/64	41311	1
1/4	41312	1
17/64	41313	1
9/32	41314	1
19/64	41315	1
5/16	41316	1
21/64	41317	1
11/32	41318	1
23/64	41319	1
3/8	41320	1
25/64	41321	1
13/32	41322	1
27/64	41323	1
7/16	41324	1
29/64	41325	1
15/32	41326	1
31/64	41327	1
1/2	41328	1

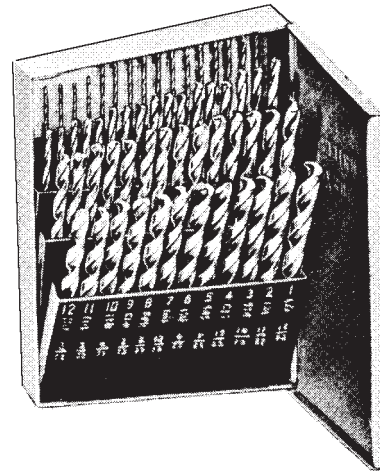

CD - 331
29 DRILLS SIZES
1/16" to 1/2"
by 64ths
IN A 99917 INDEX



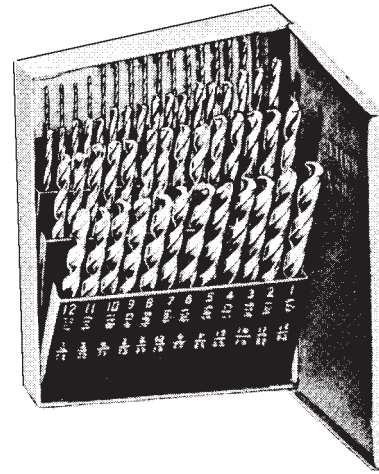



















DRILL SIZE	CHOICE PART No.	UNIT
1/16	41300	1
3/32	41302	1
1/8	41304	1
5/32	41306	1
3/16	41308	1
7/32	41310	1
1/4	41312	1
9/32	41314	1
5/16	41316	1
11/32	41318	1
3/8	41320	1
13/32	41322	1
7/16	41324	1
15/32	41326	1
1/2	41328	1

























**FRACTIONAL SIZE
 DRILL BITS
 CD - 332**

15 DRILLS SIZES
 1/16" to 1/2"
 by 32nds
 IN A 99946 INDEX

CD - 350 Headless Set Screws
99902 24 Space Tray















CHOICE DISTRIBUTION		CD-350 headless set screws				USS		111 BELL STREET W. BABYLON, NY 11704 (516) 756-0120			
1	56011  6-32 x 3/16	2	56012  6-32 x 1/4	3	56032  8-32 x 1/4	4	56035  8-32 x 1/2	5	56052  10-24 x 1/4	6	56054  10-24 x 3/8
7	56072  1/4-20 x 1/4	8	56074  1/4-20 x 3/8	9	56075  1/4-20 x 1/2	10	56076  1/4-20 x 3/4	11		12	56155  1/2-13 x 1/2
13	56093  5/16-18 x 5/16	14	56094  5/16-18 x 3/8	15	56095  5/16-18 x 1/2	16	56096  5/16-18 x 3/4	17		18	56156  1/2-13 x 3/4
19	56114  3/8-16 x 3/8	20	56115  3/8-16 x 1/2	21	56116  3/8-16 x 3/4	22	56135  7/16-14 x 1/2	23	56136  7/16-14 x 3/4	24	56157  1/2-13 x 1

CD - 352 Headless Set Screws SAE 99902 24 Space Tray





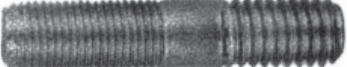



CHOICE DISTRIBUTION		CD-352 Headless Set Screws (SAE)				111 BELL STREET W. BABYLON, NY 11704 (516) 756-0120	
56210 ¹  6-40 x 1/8"	56211 ²  6-40 x 3/16"	56231 ³  8-36 x 3/16"	56232 ⁴  8-36 x 1/4"	56233 ⁵  8-36 x 5/16"	56355 ⁶  1/2-20 x 1/2"		
7	56254 ⁸  10-32 x 3/8"	56255 ⁹  10-32 x 1/2"	56252 ¹⁰  10-32 x 1/4"	11	56356 ¹²  1/2-20 x 3/4"		
56272 ¹³  1/4-28 x 1/4"	56274 ¹⁴  1/4-28 x 3/8"	56275 ¹⁵  1/4-28 x 1/2"	56276 ¹⁶  1/4-28 x 3/4"	56294 ¹⁷  5/16-24 x 3/8"	56357 ¹⁸  1/2-20 x 1"		
56293 ¹⁹  5/16-24 x 5/16"	56295 ²⁰  5/16-24 x 1/2"	56296 ²¹  5/16-24 x 3/4"	56314 ²²  3/8-24 x 3/8"	56315 ²³  3/8-24 x 1/2"	56316 ²⁴  3/8-24 x 3/4"		

CD - 354 Universal Studs
99903 16 Space Tray
5 each









CHOICE
CHOICE
DISTRIBUTION INC.
www.choice-distribution.com

CHOICE DISTRIBUTION		CD-354 Universal Studs		111 BELL STREET W. BABYLON, NY 11704 (516) 756-0120			
1	51054  5/16"-24-5/16"-18 1 1/2" Long	2	51058  5/16"-24-5/16"-18 2" Long	3	51062  3/8"-24-3/8"-16 1 1/2" Long	4	51066  3/8"-24-3/8"-16 2" Long
5	51070  3/8"-24-3/8"-16 2 1/2" Long	6	51072  3/8"-24-3/8"-16 3" Long	7	51076  7/16"-20-7/16"-14 1 3/4" Long	8	51078  7/16"-20-7/16"-14 2" Long
9	51080  7/16"-20-7/16"-14 2 1/4" Long	10	51082  7/16"-20-7/16"-14 2 1/2" Long	11		12	51084  7/16"-20-7/16"-14 3" Long
13	51088  1/2"-20-1/2"-13 2" Long	14	51090  1/2"-20-1/2"-13 2 1/4" Long	15	51092  1/2"-20-1/2"-13 2 1/2" Long	16	51094  1/2"-20-1/2"-13 3" Long

















CD - 355 Grade C USS Nylock
99905 Adjustable Space Tray

CHOICE DISTRIBUTION		CD-355 Grade C USS Nylock		111 BELL STREET W. BABYLON, NY 11704 (516) 756-0120		
20	71801  1/4-20 USS	10	71804  7/16-14 USS	5	71806  9/16-12 USS	5 71808  3/4-10 USS
20	71802  5/16-18 USS					
20	71803  3/8-16 USS	10	71805  1/2-13 USS	5	71807  5/8-11 USS	















CD - 356 Grade C SAE Nylock
99905 Adjustable Space Tray

CHOICE DISTRIBUTION		CD-356 Grade C SAE Nylock		111 BELL STREET W. BABYLON, NY 11704 (516) 756-0120		
20	71821  1/4-28 SAE	10	71824  7/16-20 SAE	5	71826  9/16-18 SAE	5 71828  3/4-16 SAE
20	71822  5/16-24 SAE	10	71825  1/2-20 SAE	5	71827  5/8-18 SAE	
20	71823  3/8-24 SAE					















CD - 357 Prevailing Torque Nuts
99903 16 Space Tray

CHOICE DISTRIBUTION		CD-357 Prevailing Torque Nuts		215K CENTRAL AVENUE FARMINGDALE, NY 11735 (516) 756-0120	
37780 1	 1/4"-20 (USS) 25	37781 2	 5/16"-18 (USS) 25	37782 3	 3/8"-16 (USS) 25
37783 4	 7/16"-14 (USS) 25	37784 5	 1/2"-13 (USS) 10	37785 6	 9/16"-12 (USS) 10
37786 7	 5/8"-11 (USS) 5	37787 8	 3/4"-10 (USS) 5	37795 9	 1/4"-28 (SAE) 25
37796 10	 5/16"-24 (SAE) 25	37797 11	 3/8"-24 (SAE) 25	37798 12	 7/16"-20 (SAE) 25
37799 13	 1/2"-20 (SAE) 10	37800 14	 9/16"-18 (SAE) 10	37801 15	 5/8"-18 (SAE) 5
37802 16	 3/4"-16 (SAE) 5				





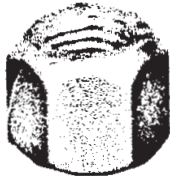



















CD - 358 Elastic Stop Nuts
99905 Adjustable Space Tray







CHOICE DISTRIBUTION	CD-358 elastic stop nut		111 BELL STREET W. BABYLON, NY 11704 (516) 756-0120
<p>25</p> <p>31800</p>  <p>10 - 24</p>	<p>25</p> <p>31802</p>  <p>5/16" - 18</p>	<p>25</p> <p>31822</p>  <p>5/16" - 24</p>	<p>10</p> <p>31807</p>  <p>5/8" - 11</p>
<p>25</p> <p>31820</p>  <p>10 - 32</p>	<p>25</p> <p>31803</p>  <p>3/8" - 16</p>	<p>25</p> <p>31823</p>  <p>3/8" - 24</p>	<p>10</p> <p>31827</p>  <p>5/8" - 18</p>
<p>25</p> <p>31801</p>  <p>1/4" - 20</p>	<p>25</p> <p>31804</p>  <p>7/16" - 14</p>	<p>25</p> <p>31824</p>  <p>7/16" - 20</p>	
<p>25</p> <p>31821</p>  <p>1/4" - 28</p>	<p>10</p> <p>31805</p>  <p>1/2" - 13</p>	<p>10</p> <p>31825</p>  <p>1/2" - 20</p>	

CD - 359 Prevailing Torque High Nuts
99903 16 Space Tray

CHOICE DISTRIBUTION		CD-359 Prevailing Torque High Nut		111 BELL STREET W. BABYLON, NY 11704 (516) 756-0120	
<p>38921¹</p>  <p>1/4" - 20 (USS)</p> <p>25</p>	<p>38922²</p>  <p>5/16" - 18 (USS)</p> <p>25</p>	<p>38923³</p>  <p>3/8" - 16 (USS)</p> <p>25</p>	<p>38924⁴</p>  <p>7/16" - 14 (USS)</p> <p>25</p>		
<p>38925⁵</p>  <p>1/2" - 13 (USS)</p> <p>10</p>	<p>38926⁶</p>	<p>38927⁷</p>  <p>5/8" - 11 (USS)</p> <p>5</p>	<p>38928⁸</p>  <p>3/4" - 10 (USS)</p> <p>5</p>		
<p>38931⁹</p>  <p>1/4" - 28 (SAE)</p> <p>25</p>	<p>38932¹⁰</p>  <p>5/16" - 24 (SAE)</p> <p>25</p>	<p>38933¹¹</p>  <p>3/8" - 24 (SAE)</p> <p>25</p>	<p>38934¹²</p>  <p>7/16" - 20 (SAE)</p> <p>25</p>		
<p>38935¹³</p>  <p>1/2" - 20 (SAE)</p> <p>10</p>	<p>38936¹⁴</p>	<p>38937¹⁵</p>  <p>5/8" - 18 (SAE)</p> <p>5</p>	<p>38938¹⁶</p>  <p>3/4" - 16 (SAE)</p> <p>5</p>		

CD - 360 Fibre Washers
 99902 24 Space Tray
 10 each



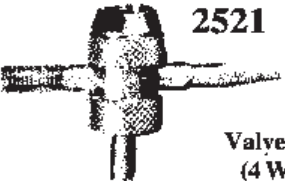









CHOICE DISTRIBUTION		CD-360 Fibre Washers				111 BELL STREET W. BABYLON, NY 11704 (631) 756-0120					
41452	1	41459	2	41467	3	41475	4	41481	5	41485	6
											
1/8" x 1/4" x 1/32"		7/32" x 9/16" x 1/32"		5/16" x 9/16" x 1/32"		1/2" x 7/8" x 1/16"		5/8" x 7/8" x 3/64"		7/8" x 1-3/16" x 1/16"	
41455	7	41461	8	41469	9	41476	10	41482	11	41486	12
											
3/16" x 9/32" x 1/16"		1/4" x 7/16" x 1/31"		3/8" x 9/16" x 1/32"		9/16" x 7/8" 1/16"		5/8" x 1" x 1/16"		7/8" x 1-5/16" x 3/32"	
41456	13	41464	14	41470	15	41477	16	41483	17	41487	18
											
3/16" 3/8" x 1/32"		9/32" x 1/2" x 3/64"		3/8" x 11/16" x 3/64"		9/16" x 3/4" x 1/32"		3/4" x 1-1/8" x 3/64"		1 x 1-5/16" x 1/16"	
41457	19	41466	20	41474	21	41480	22	41484	23	41488	24
											
3/16" x 5/8" x 1/64"		5/16" x 1/2" x 1/32"		1/2" x 3/4" x 1/16"		19/32" x 1" x 1/16"		3/4" x 1-3/16" x 1/16"		1 x 1-7/16" x 3/32"	







CHOICE DISTRIBUTION		CD-365 Tire Valve Assortment		111 BELL STREET W. BABYLON, NY 11704 (631) 756-0120	
<p>2502</p>  <p>25 Valve Cap</p>		<p>2512</p>  <p>5</p> <p>Valve Stem 1-1/4" Length .453 Dia. Rim Hole</p>	<p>2514</p>  <p>5</p> <p>Valve Stem 1-1/4" Length .625 Dia. Rim Hole (5/8")</p>		
<p>2500</p>  <p>25 Valve Stem Core</p>		<p>2516</p>  <p>5</p> <p>Valve Stem 1-1/2" Length .453 Dia. Rim Hole</p>			
		<p>2518</p>  <p>5</p> <p>Valve Stem 2-1/2" Length .453 Dia. Rim Hole</p>	<p>2520</p>  <p>5</p> <p>Valve Stem 2" Length .625 Dia. Rim Hole (5/8)</p>		
	<p>2521</p>  <p>1</p> <p>Valve Tool (4 Way)</p>				

CD - 366 Tee Fittings and Hose Connectors
 99937 20 Space Tray
 99936 Outside Shell













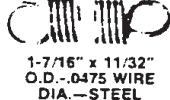

CHOICE DISTRIBUTION		CD-366 Tee Fittings and Hose Connectors		111 BELL STREET W. BABYLON, NY 11704 (631) 756-0120	
5	71152 Connector Nylon for 1/8" I.D. Hose 1 1/16" Length	5	71160 "T" Fitting Plastic For 1/8" Hose	5	71167 "T" Fitting Plastic For 3/16" & 1/8" Hose
5	71153 Connector Nylon for 3/16" I.D. Hose 1 5/8" Length	5	71163 1/8" Vacuum Cap	5	71151 3/16" Vacuum Cap
5	71154 Connector Nylon for 1/4" I.D. Hose 1 9/16" Length	5	71166 "T" Fitting Plastic For 1/8" & 1/4" Hose	5	71150 1/4" Vacuum Cap
5	71156 Connector Nylon Reducing For 1/4" I.D. Hose To 3/16" I.D. Hose	5	71164 3/8" Vacuum Cap	5	71165 5/16" Vacuum Cap
5	71155 Connector Nylon for 5/16" I.D. Hose 1 5/8" Length	5	71157 "T" Fitting Plastic For 3/16" Hose	5	71162 Four Way Vacuum Tee Nylon For 3/16" Hose
5	71158 "T" Fitting Plastic For 1/4" Hose	5	71169 Five Way Vacuum Tee Nylon For 3/16" Hose	5	71161 Connector Plastic w/Break-off Section For 1/8", 1/4", 3/8", I.D. Hose
5	71159 "T" Fitting Plastic w/Break-off Section For 1/8", 3/16, 1/4", 5/16", I.D. Hose				

CD - 367 Compression Springs
99905 Adjustable Space Tray

CHOICE DISTRIBUTION		CD-367 Compression Springs		111 BELL STREET W. BABYLON, NY 11704 (516) 756-0120	
 55052 1-1/4 IN.	10	 55060 31/32 IN.	10	 55066 3-1/16 IN.	5
 55055 25/32 IN.	10	 55061 2-5/32 IN.	10	 55068 2-1/32 IN.	5
 55054 1-21/32 IN.	10	 55063 2-27/32 IN.	10	 55067 2-1/32 IN.	5
 55059 2-1/2 IN.	10	 55057 2-5/8 IN.	10	 55070 3-5/8 IN.	5

CHOICE DISTRIBUTION	CD-368 Compression Springs	111 BELL STREET W. BABYLON, NY 11704 (516) 756-0120
 55062 11-1/2 IN.	5	
 55064 4-1/16 IN.	5	
 55065 10 IN.	5	
 55056 11 - 1/2 IN.	5	
 55050 10 IN.	5	
 55066 3-1/16 IN.	5	

CD - 369 Spring Assortment
 99905 Adjustable Space Tray
 5 each



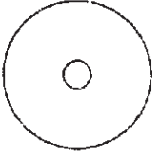
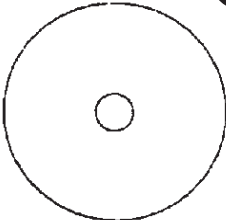
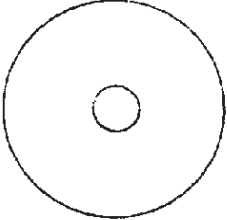
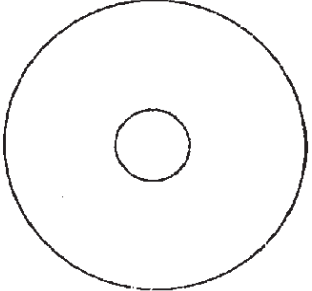
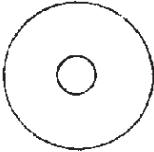
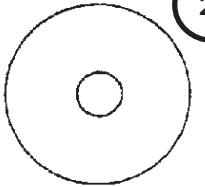
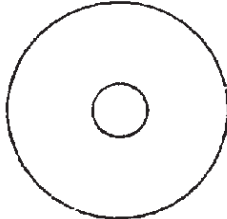
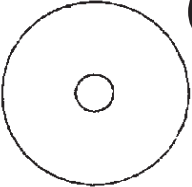

CHOICE DISTRIBUTION	CD-369 Spring Assortment		111 BELL STREET W. BABYLON, NY 11704 (516) 756-0120
<p>55027 5-1/4" x 17/32" O.D.-.0625 WIRE DIA.-STEEL</p> 	<p>55024 4-1/2" x 31/64" O.D.-.063 WIRE DIA.-STEEL</p> 	<p>55026 1-5/8" x 1.2" O.D.-.080 WIRE DIA.-STEEL</p> 	<p>55014 1-7/16" x 11/32" O.D.-.0475 WIRE DIA.-STEEL</p> 
<p>55019 3-1/4" x 3/8" O.D.-.040 WIRE DIA.-STEEL</p> 	<p>55013 6-1/2" x 21/64" O.D.-.035 WIRE DIA.-STEEL</p> 	<p>55010 1-1/8" x 19/64" O.D.-.040 WIRE DIA.-BRASS</p> 	<p>55005 1-1/8" x 15/64" O.D.-.020 WIRE DIA.-STEEL</p> 
<p>55006 4" x 1/4" O.D.-.029 WIRE DIA.-STEEL</p> 	<p>55007 5-3/4" x 1/4" O.D.-.029 WIRE DIA.-STEEL</p> 	<p>55035 4" x 23/32" O.D.-.1055 WIRE DIA.-STEEL</p> 	<p>55036 4-1/16" x 47/64" O.D.-.0625 WIRE DIA.-STEEL</p> 
<p>55007 5-3/4" x 1/4" O.D.-.029 WIRE DIA.-STEEL</p> 	<p>55022 6-7/16" x 7/16" O.D.-.048 WIRE DIA.-STEEL</p> 	<p>55028 5-5/8" x 35/64" O.D.-.080 WIRE DIA.-STEEL</p> 	<p>55028 5-5/8" x 35/64" O.D.-.080 WIRE DIA.-STEEL</p> 







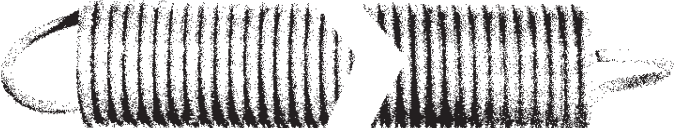

CD - 370 Fender Washers
 99905 Adjustable Space Tray

CHOICE DISTRIBUTION	CD-370 Fender Washers		111 BELL STREET W. BABYLON, NY 11704 (516) 756-0120
 <p>25 42570 3/16 * 1</p>	 <p>25 42577 1/4 * 1 1/2</p>	 <p>25 42575 5/16 * 1 1/2</p>	 <p>25 42581 1/2 * 2</p>
 <p>25 42572 1/4 * 1</p>	 <p>25 42579 5/16 * 1 1/4</p>	 <p>25 42580 3/8 * 1 1/2</p>	
 <p>25 42574 1/4 * 1 1/4</p>			



CD - 371 Universal Extension Springs
 99906 Long Space Tray
 5 each

CHOICE
CHOICE
 DISTRIBUTION INC.
www.choice-distribution.com

CHOICE DISTRIBUTION	CD-371 UNIVERSAL EXTENTION SPRINGS	111 BELL STREET W. BABYLON, NY 11704 (631) 756-0120
55045	ACCELERATOR CONTROL PULL BACK SPRING O.D. 7/16 STEEL	
55022	6-7/16" x 7/16" O.D. .048 WIRE DIA. STEEL	
55043	10" x 1/2" O.D. .062 WIRE DIA. STEEL	
55032	10" x 5/8" O.D. .072 WIRE DIA. STEEL	
55039	10" x 13/16" O.D. .072 WIRE DIA. STEEL	
55042	8-1/2" x 1" O.D. .1055 WIRE DIA. STEEL	

CHOICE DISTRIBUTION	CD-372 wall grips		111 BELL STREET W. BABYLON, NY 11704 (516) 756-0120
<p>15188</p>  <p>DRIVE WALL GRIP ANCHOR 1/8" DS x 1 5/8"</p> <p>25</p>	<p>15180</p>  <p>WALL GRIP ANCHOR 1/8" S x 1 5/8" (USE 5/16" DRILL)</p> <p>25</p>	<p>15185</p>  <p>WALL GRIP ANCHOR 3/16" S x 1 5/16" (USE 3/8" DRILL)</p> <p>25</p>	<p>15002</p>  <p>PLASTIC ANCHOR LENGTH 7/8" SCREW SIZE 8-10 DIA. (USE 3/16" DRILL)</p> <p>100</p>
<p>15189</p>  <p>DRIVE WALL GRIP ANCHOR 1/8" DL x 2"</p> <p>25</p>	<p>15181</p>  <p>WALL GRIP ANCHOR 1/8" L x 2" (USE 5/16" DRILL)</p> <p>25</p>	<p>15186</p>  <p>WALL GRIP ANCHOR 3/16" L x 1 13/16" (USE 3/8" DRILL)</p> <p>25</p>	<p>15004</p>  <p>PLASTIC ANCHOR LENGTH 1" SCREW SIZE 10-12 DIA. (USE 1/4" DRILL)</p> <p>100</p>
			<p>15006</p>  <p>PLASTIC ANCHOR LENGTH 1 3/8" SCREW SIZE 14-16 DIA. (USE 5/16" DRILL)</p> <p>100</p>

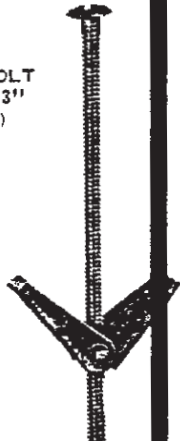
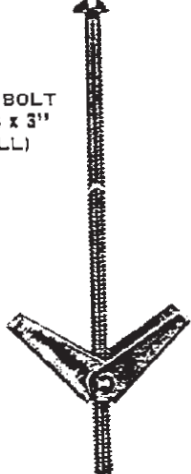
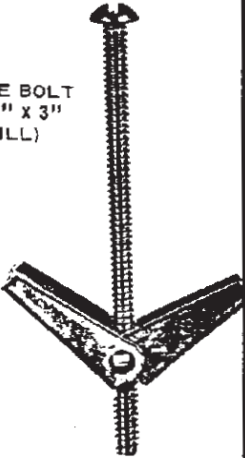
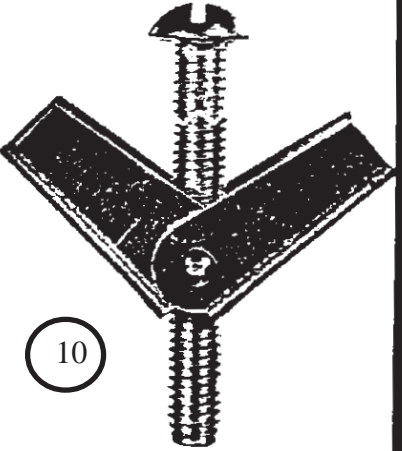
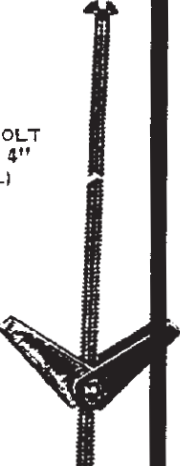
CD - 373 Toggle Bolts
99905 Adjustable Space Tray

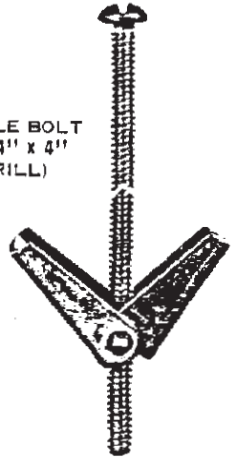
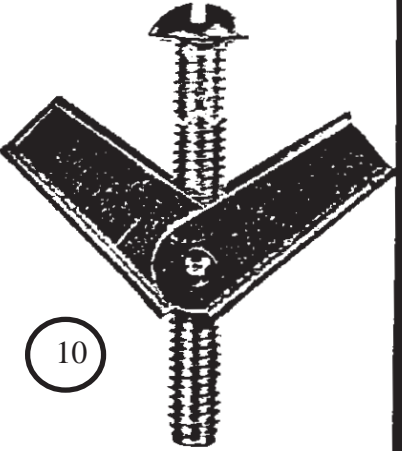
CHOICE DISTRIBUTION	CD-373	toggle bolts		111 BELL STREET W. BABYLON, NY 11704 (516) 756-0120
<p>15150</p> <p>SNAP-IN TOGGLE BOLT BOLT SIZE 6-32 x 3" (USE 3/8" DRILL)</p> <p>25</p> 	<p>15152</p> <p>SNAP-IN TOGGLE BOLT BOLT SIZE 10-24 x 3" (USE 1/2" DRILL)</p> <p>25</p> 	<p>15154</p> <p>SNAP-IN TOGGLE BOLT BOLT SIZE 1/4" x 3" (USE 5/8" DRILL)</p> <p>25</p> 	<p>15158</p> <p>SNAP-IN TOGGLE BOLT BOLT SIZE 3/8" x 6" (USE 7/8" DRILL)</p>  <p>10</p>	
<p>15151</p> <p>SNAP-IN TOGGLE BOLT BOLT SIZE 6-32 x 4" (USE 3/8" DRILL)</p> <p>25</p> 	<p>15153</p> <p>SNAP-IN TOGGLE BOLT BOLT SIZE 10-24 x 4" (USE 1/2" DRILL)</p> <p>25</p> 	<p>15155</p> <p>SNAP-IN TOGGLE BOLT BOLT SIZE 1/4" x 4" (USE 5/8" DRILL)</p> <p>25</p> 	 <p>10</p>	

CD - 374 Stainless Steel Fender Washers
99905 Adjustable Space Tray

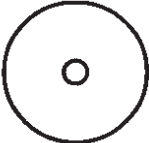
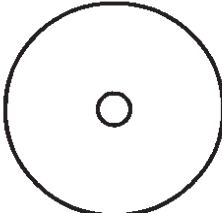
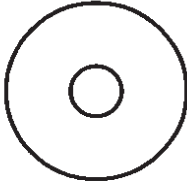
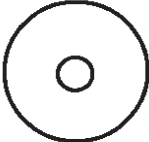
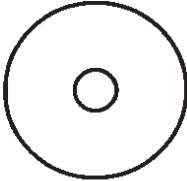
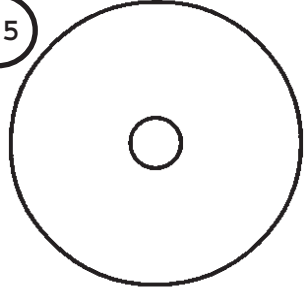
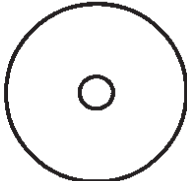
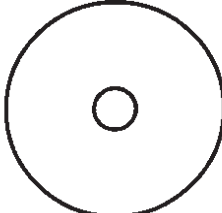
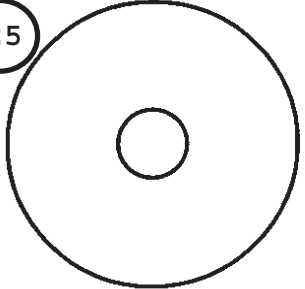
CHOICE DISTRIBUTION		CD-374 STAINLESS STEEL FENDER WASHERS		111 BELL STREET W. BABYLON, NY 11704 (631) 756-0120	
 74400 #10 I.D. 1" O.D.	25	 74403 1/4" I.D. 1-1/2" O.D.	25	 74407 3/8" I.D. 1-1/4" O.D.	25
 74401 1/4" I.D. 1" O.D.	25	 74405 5/16" I.D. 1-1/4" O.D.	25	 74409 3/8" I.D. 2" O.D.	25
 74402 1/4" I.D. 1-1/4" O.D.	25	 74406 5/16" I.D. 1-1/2" O.D.	25	 74410 1/2" I.D. 2" O.D.	25

CHOICE
DISTRIBUTION

CD-375 SPIRAL ANCHORS

111 BELL STREET
W. BABYLON, NY 11704
(516) 756-0120

15012

METAL SPIRAL ANCHOR
Corrosion resistant long lasting
zinc material.
Breakaway point for shallow
cavities behind wall board.

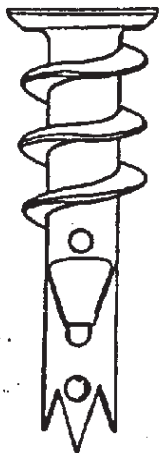

25

15010

PLASTIC SPIRAL ANCHOR
Du Pont ZYTEL nylon
Electrically non-conductive
Uses #8 sheet metal screw or
dry wall screw.



25

50



32824
8 x 3/4
Phillips Pan Head
Sheet Metal Screws

50

32828



8 x 1 1/2
Phillips Pan Head
Sheet Metal Screws

32826



50

8 x 1
Phillips Pan Head
Sheet Metal Screws

32827



50

8 x 1 1/4
Phillips Pan Head
Sheet Metal Screws











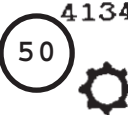

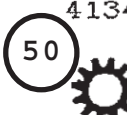







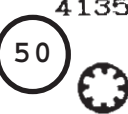

32830

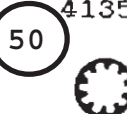











8 x 2
Phillips Pan Head
Sheet Metal Screws

50

CD - 376 Shakeproof Washers
99902 24 Space Tray

CHOICE DISTRIBUTION		CD-376 shakeproof washers				215K CENTRAL AVENUE FARMINGDALE, NY 11735 (516) 756-0120
<p>41362 1</p>  <p>No. 10 Countersunk External Tooth</p>	<p>41341 2</p>  <p>No. 8 Flat External Tooth</p>	<p>41342 3</p>  <p>No. 10 Flat External Tooth</p>	<p>41343 4</p>  <p>No. 12 Flat External Tooth</p>	<p>41344 5</p>  <p>1/4" Flat External Tooth</p>	<p>41345 6</p>  <p>5/16" Flat External Tooth</p>	
<p>41364 7</p>  <p>1/4" Countersunk External Tooth</p>	<p>41346 8</p>  <p>3/8" Flat External Tooth</p>	<p>41347 9</p>  <p>7/16" Flat External Tooth</p>	<p>41348 10</p>  <p>1/2" Flat External Tooth</p>	<p>41349 11</p>  <p>5/8" Flat External Tooth</p>	<p>41349-1 12</p>  <p>3/4" Flat External Tooth</p>	
<p>41365 13</p>  <p>5/16" Countersunk External Tooth</p>	<p>41351 14</p>  <p>No. 8 Flat Internal Tooth</p>	<p>41352 15</p>  <p>No. 10 Flat Internal Tooth</p>	<p>41353 16</p>  <p>No. 12 Flat Internal Tooth</p>	<p>41354 17</p>  <p>1/4" Flat Internal Tooth</p>	<p>41355 18</p>  <p>5/16" Flat Internal Tooth</p>	
<p>41366 19</p>  <p>3/8" Countersunk External Tooth</p>	<p>41356 20</p>  <p>3/8" Flat Internal Tooth</p>	<p>41357 21</p>  <p>7/16" Flat Internal Tooth</p>	<p>41358 22</p>  <p>1/2" Flat Internal Tooth</p>	<p>41359 23</p>  <p>5/8" Flat Internal Tooth</p>	<p>41359-1 24</p>  <p>3/4" Flat Internal Tooth</p>	

CHOICE DISTRIBUTION		CD-377 Garden Hose Fittings		111 BELL STREET W. BABYLON, NY 11705 76311 756-0123	
Female Garden Hose X 1/2 Female Pipe  80087 (5)	Female Garden Hose X 1/2 Male Pipe  80086 (5)	Male Garden Hose X 1/2 Female Pipe  80082 (5)	Male Garden Hose X 3/4 Male Pipe  80081 (5)		
3/4 Male Garden Hose X 3/4 Male Garden Hose  80084 (5)	Female Garden Hose X Female Garden Hose  80089 (5)	Female Swivel Garden Hose X 5/8 Hose Barb Brass  80093 (5)	Female Swivel Garden Hose X 3/4 Hose Barb Brass  80094 (5)		
Garden Hose Washer  80080 (25)	Female Swivel Garden Hose X Female Swivel Garden Hose  80091 (5)				

CD - 379 Toggler Anchor System
 99905 Adjustable Space Tray
 25 each

**CHOICE
 DISTRIBUTION**

CD-379 TOGGLER Anchor Systems

111 BELL STREET
 W. BABYLON, NY 11704
 (631) 756-0120

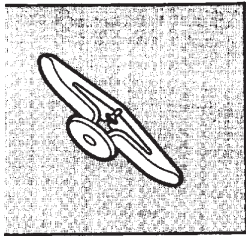

PANEL ANCHOR: (No. TA)
 Ideal for wall materials 1/8"-1/4" or thicker. Solves the problem of hanging hooks, towel bars, mirrors, or anything, on hollow core doors, thin plywood or hardboard paneling.

34950

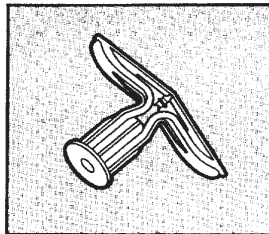

1" DRYWALL ANCHOR: (No. TD)
 Ideal for wall materials 1" and thicker. This anchor solves the problem of anchoring in thick plaster, concrete, brick, and masonry walls. Perfect for many buildings where two or more layers of drywall boards are used.

34953

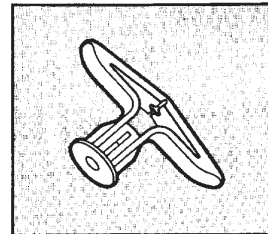

PLASTER WALL ANCHOR: (No. TC)
 Ideal for wall materials 3/8"-3/4" or thicker. Perfect for plaster walls found in many older homes and for 5/8" drywall found in commercial buildings.

34952

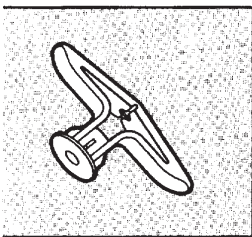

T-WALL ANCHOR: (No. TB)
 Ideal for wall materials 3/8"-1/2" or thicker. This anchor is the most popular size and solves all household fastening problems. It hangs heavy hardware, telephones, pictures, mirrors, lamps, kitchen and bath accessories, shelves, and much more, on any type of wall, hollow or solid.

34951

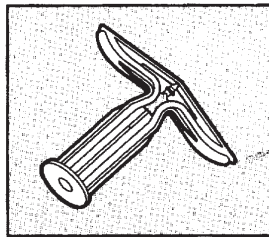

39mm DRYWALL ANCHOR: (No. T39)
 Ideal for wall materials 39mm (1 1/2") and thicker. These anchors solve the problem of anchoring in walls of more than one substrate, such as tile over drywall, paneling over drywall, multi-layer drywall, composite panels, plaster, concrete, brick, masonry, etc.

34955

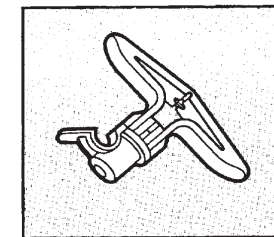

PICTURE HOOK ANCHOR: (No. TH)
 Ideal for wall materials 3/8"-1/2" or thicker. This anchor is generally used for hanging picture and mirrors, but the hook anchor can also be used to carry 4-strand telephone wire and small cables.

34956

CD - 380 Toggler Anchor System
99905 Adjustable Space Tray
25 each

CHOICE
CHOICE
DISTRIBUTION INC.
www.choice-distribution.com

CHOICE
DISTRIBUTION

CD-380 **TOGGLER**[®] ANCHOR SYSTEM

111 BELL STREET
W. BABYLON, NY 11704
(516) 756-0120

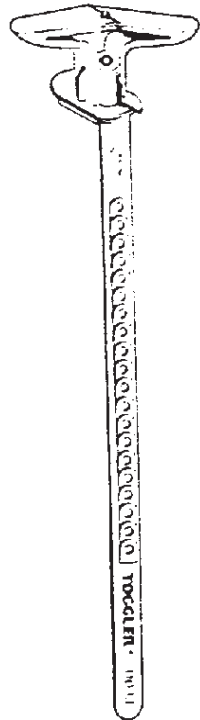

for 1/8"-1/4" walls

34968

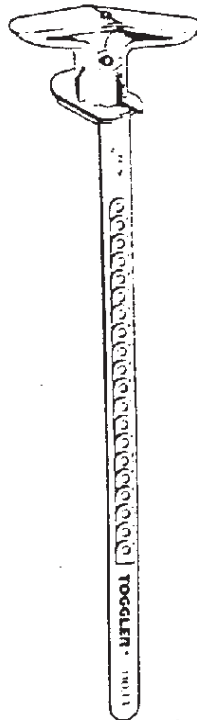

for 3/8"-1/2" walls

34969

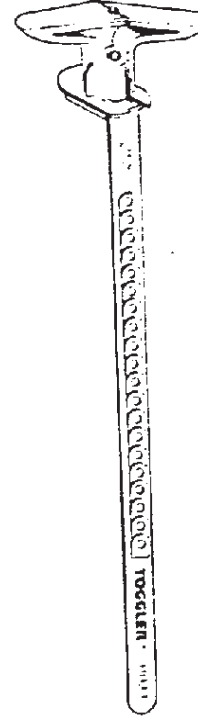

for 5/8"-3/4" walls

34970

CD - 381 Toggler Anchor System
 99905 Adjustable Space Tray
 25 each

CHOICE
DISTRIBUTION

CD-381 **TOGGLER**® ANCHOR SYSTEM

215K CENTRAL AVENUE
 FARMINGDALE, NY 11735
 (516) 756-0120

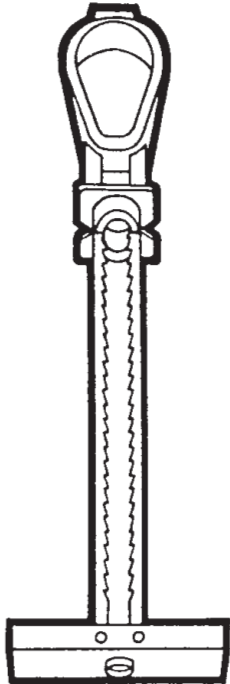

BOLT SIZE	DRILL SIZE
3/16-24	1/2"

34960

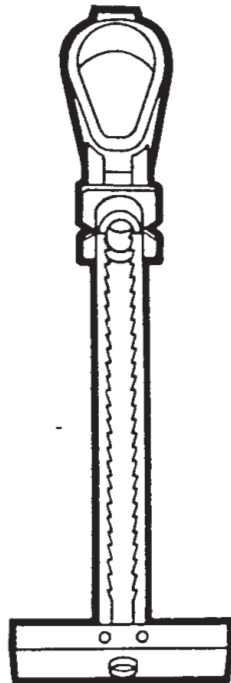

BOLT SIZE	DRILL SIZE
1/4-20	1/2"

34961

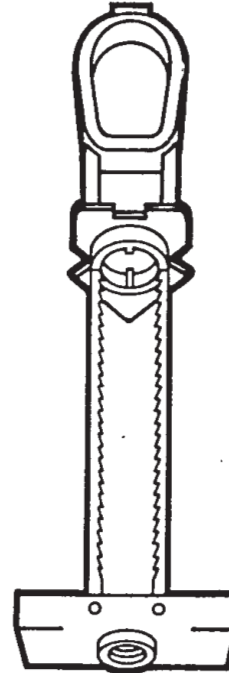

BOLT SIZE	DRILL SIZE
3/8-16	3/4"

34962

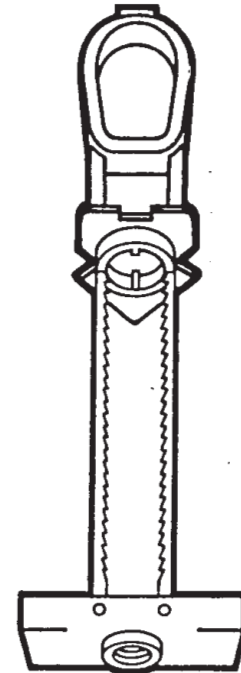

BOLT SIZE	DRILL SIZE
1/2-13	3/4"

34963













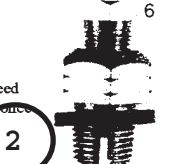

CD - 382 Drain Plugs
 99937 20 Space Tray
 99936 Outside Shell

CHOICE
CHOICE
 DISTRIBUTION INC.
 www.choice-distribution.com

CHOICE
DISTRIBUTION

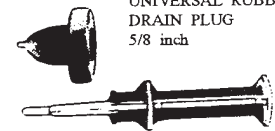
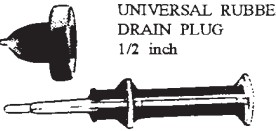











CD-382 Drain Plugs

111 BELL STREET
 W. BABYLON, NY 11704
 (516) 756-0120

<p>8804 1</p> <p>DRAIN PLUG, Oil Pan 1/2-20 x 1/2" - Head 7/8" Across Flats - 1/4" Thick Supplied w/gasket</p>  <p>2</p>	<p>8805 2</p> <p>DRAIN PLUG, Oil Pan 1/2-20 x 1/2" - Head 7/8" Across Flats - 1/4" Thick Plated</p>  <p>2</p>	<p>8806 3</p> <p>DRAIN PLUG, Oil Pan 1/2" Oversize Self-tapping w/gasket</p>  <p>2</p>	<p>8807 4</p> <p>DRAIN PLUG, Oil Pan 1/2" Dbl. Oversize Self-tapping w/gasket</p>  <p>2</p>
<p>8808 5</p> <p>DRAIN PLUG, Oil Pan 1/2" Triple. Oversize Self-tapping w/gasket</p>  <p>2</p>	<p>8809 6</p> <p>DRAIN PLUG, Oil Pan 1/2" Oversize Center drain plug eliminates need for removal of complete plug once installed Self-tapping w/gasket</p>  <p>2</p>	<p>8830 7</p> <p>DRAIN PLUG, Oil Pan 12mm x 1.25 x 11 Hd. Dia. 14mm DATSUN 1.6-2.0L 1962-1987 Supplied w/gasket</p>  <p>2</p>	<p>8832 8</p> <p>DRAIN PLUG, Oil Pan 12mm Standard GENERAL MOTORS Supplied w/gasket</p>  <p>2</p>
<p>8834 9</p> <p>DRAIN PLUG, Oil Pan 14mm Standard FORD PROD. Supplied w/gasket</p>  <p>2</p>	<p>8838 10</p> <p>DRAIN PLUG, Oil Pan 18mm x 1.5 x 13 Hd. Dia. 19mm CHRYSLER All 1969-87 RENAULT All 1975-1979 TOYOTA All 1969-87 Supplied w/gasket</p>  <p>2</p>	<p>8836 11</p> <p>DRAIN PLUG, Oil Pan 16mm x 1.5 x 13 Hd. Dia. 22mm DATSUN 2.4-2.8L 1962-87 RENAULT All 1979-1987 Supplied w/gasket</p>  <p>2</p>	<p>8840 12</p> <p>DRAIN PLUG, Oil Pan 20mm x 1.5 x 13 Hd. Dia. 17mm HONDA All 1975-87 LUVTRUCK All 1975-1987 SUBARU All 1974-87 Supplied w/gasket</p>  <p>2</p>
<p>8822 13</p> <p>UNIVERSAL RUBBER DRAIN PLUG 5/8 inch</p>  <p>2</p>	<p>8824 14</p> <p>UNIVERSAL RUBBER DRAIN PLUG 1/2 inch</p>  <p>2</p>	<p>15</p>	<p>16</p>
<p>17</p>	<p>8814 18</p> <p>1/2 in.</p>  <p>10</p>	<p>8816 19</p> <p>9/16 in. USED w/OVER-SIZED DRAIN PLUGS</p>  <p>10</p>	<p>8818 20</p> <p>9/16 in. USED w/DOUBLE OVER-SIZED DRAIN PLUGS</p>  <p>10</p>

CD - 383 Copper Gaskets
 99903 16 Space Tray
 10 each

CHOICE
CHOICE
 DISTRIBUTION INC.
www.choice-distribution.com

CHOICE DISTRIBUTION		CD-383 Copper gaskets		215K CENTRAL AVENUE FARMINGDALE, NY 11735 (516) 756-0120	
1275	1	1279	2	1283	3
	1/4" BOLT SIZE 5/16" I.D. 7/16" O.D.		7/16" BOLT SIZE 29/64" I.D. 11/16" O.D.		1/2" BOLT SIZE 17/32" I.D. 13/16" O.D.
1276	5	1280	6	1284	7
	5/16" BOLT SIZE 21/64" I.D. 1/2" O.D.		7/16" BOLT SIZE 15/32" I.D. 13/16" O.D.		1/2" BOLT SIZE 9/16" I.D. 13/16" O.D.
1277	9	1281	10	1285	11
	3/8" BOLT SIZE 13/32" I.D. 5/8" O.D.		1/2" BOLT SIZE 33/64" I.D. 45/64" O.D.		9/16" BOLT SIZE 39/64" I.D. 13/16" O.D.
1278	13	1282	14	1286	15
	3/8" BOLT SIZE 7/16" I.D. 13/16" O.D.		1/2" BOLT SIZE 33/64" I.D. 13/16" O.D.		5/8" BOLT SIZE 21/32" I.D. 1" O.D.
					16

CD - 385 Heavy Duty Fender Washers
99905 Adjustable Space Tray

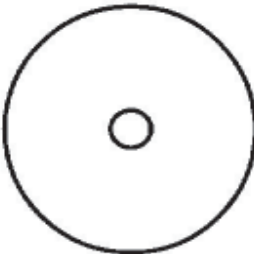
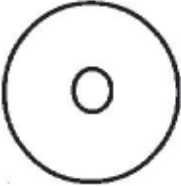
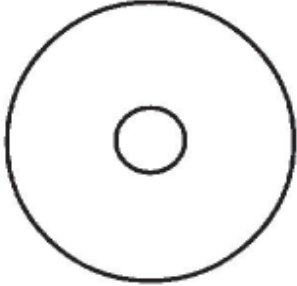
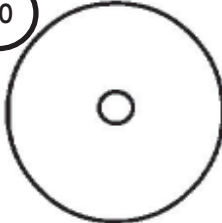
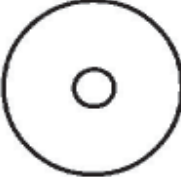
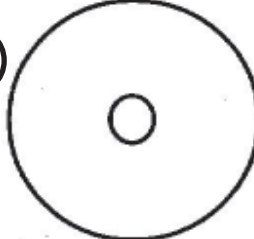
CHOICE DISTRIBUTION		CD-385 HEAVY DUTY FENDER WASHERS		111 BELL STREET W. BABYLON, NY 11704 (516) 756-0120	
<p>10</p>  <p>54572 1/4" I.D. 1" O.D.</p>	<p>10</p>  <p>54576 5/16" I.D. 1-3/4" O.D.</p>	<p>10</p>  <p>54579 5/16" I.D. 1-1/4" O.D.</p>	<p>10</p>  <p>54581 1/2" I.D. 2" O.D.</p>		
<p>10</p>  <p>54574 1/4" I.D. 1-1/2" O.D.</p>	<p>10</p>  <p>54578 3/8" I.D. 1-1/4" O.D.</p>	<p>10</p>  <p>54580 3/8" I.D. 1-3/4" O.D.</p>			

**CHOICE
DISTRIBUTION**

CD-387 SPEEDTHREADER

111 BELL STREET
W. BABYLON, NY 11704
(631) 756-0120

1

68211
1/2-13



1

68210
7/16-14



1

68209
3/8-16



1

68208
5/16-18



1

68207
1/4-20



**CHOICE
DISTRIBUTION**

CD-390 METRIC SPEEDTHREADER

111 BELL STREET
W. BABYLON, NY 11704
(631) 756-0120

1

68206
M12 x 1.75



1

68205
M10 x 1.5



1

68204
M8 x 1.25



1

68203
M6 x 1



1

68202
M5 x .8



68200
M3 x .5









1

68201
M4 x .7



1

CD - 391 Rod Couplers
99905 Adjustable Space Tray

CHOICE DISTRIBUTION		CD-391 Rod Couplers		111 BELL STREET W. BABYLON, NY 11704 (516) 756-0120	
<p>10</p> <p>33990</p>  <p>1/4 x 20 Rod Couplers</p>	<p>10</p> <p>33992</p>  <p>3/8 x 16 Rod Couplers</p>	<p>3</p> <p>33995</p>  <p>5/8 x 11 Rod Couplers</p>	<p>3</p> <p>33996</p>  <p>3/4 x 10 Rod Couplers</p>		
<p>10</p> <p>33991</p>  <p>5/16 x 18 Rod Couplers</p>	<p>10</p> <p>33994</p>  <p>1/2 x 13 Rod Couplers</p>				

THREADED ROD ASSORTMENTS

B-7 Threaded Rod Stock

- Alloy Steel
- Multiple heat treated
- 125,000 PSI tensile strength
- Yellow Zinc Plated

99924 THREADED ROD RACK

CD-392 UNC (USS) 3 Foot Lengths

SIZE	TPI	CHOICE USS	QTY.
1/4	20	37665	3
5/16	18	37666	3
3/8	16	37667	3
7/16	14	37668	3
1/2	13	37669	3
9/16	12	37670	2
5/8	11	37671	2
3/4	10	37672	2
RANGE	*	LABELS	1

CD-393 UNF (SAE) 3 Foot Lengths

SIZE	TPI	CHOICE SAE	QTY.
1/4	28	37680	3
5/16	24	37681	3
3/8	24	37682	3
7/16	20	37683	3
1/2	20	37684	3
9/16	18	37685	2
5/8	18	37686	2
3/4	16	37687	2
RANGE	*	LABELS	1

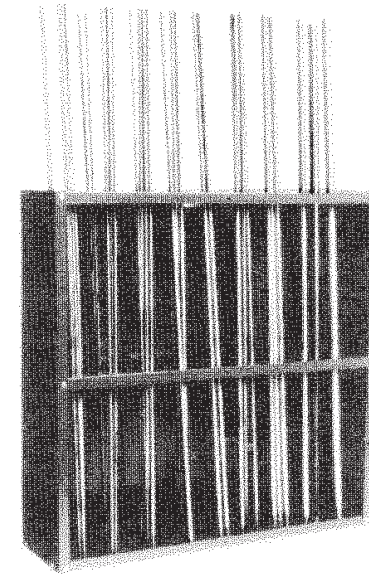

THREADED ROD ASSORTMENTS

Grade 5 Threaded Rod Stock

- Alloy Steel
- Heat treated
- Zinc Plated

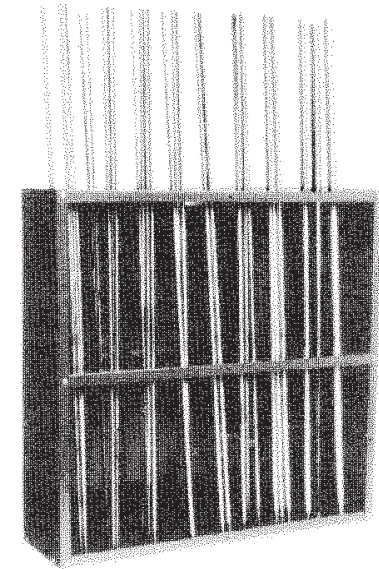

99924 THREADED ROD RACK

CD-394
 UNC (USS)
 3 Foot Lengths

CD-395
 UNF (SAE)
 3 Foot Lengths

SIZE	TPI	CHOICE USS	QTY.
1/4	20	31840	3
5/16	18	31841	3
3/8	16	31842	3
7/16	14	31843	3
1/2	13	31844	3
9/16	12	31845	2
5/8	11	31846	2
3/4	10	31847	1
RANGE	*	LABELS	1

SIZE	TPI	CHOICE SAE	QTY.
1/4	28	31855	3
5/16	24	31856	3
3/8	24	31857	3
7/16	20	31858	3
1/2	20	31859	3
9/16	18	31860	2
5/8	18	31861	2
3/4	16	31862	1
RANGE	*	LABELS	1

THREADED ROD ASSORTMENTS

18-8 Stainless Steel

99924 THREADED ROD RACK

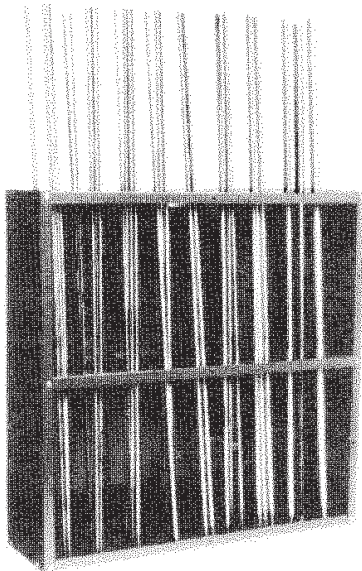

CD-396
 UNC (USS)
 3 Foot Lengths

SIZE	TPI	CHOICE USS	QTY.
1/4	20	39665	3
5/16	18	39666	3
3/8	16	39667	3
1/2	13	39669	3
5/8	11	39671	2
3/4	10	39672	1
RANGE	*	LABELS	1

BRAKE LINE ASSORTMENTS

99941 3/16-1/4 BRAKE LINE RACK

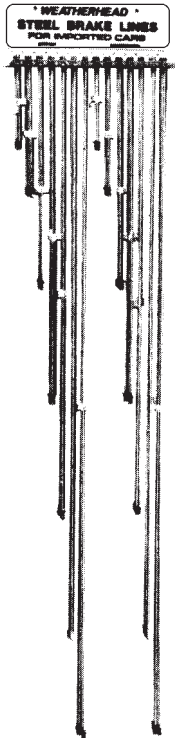

CD-400

3/16" & 1/4"

STEEL BRAKE LINE TUBING

3/16" TUBE		
LENGTH	PART #	QTY.
12	90651	3
20	90652	3
30	90653	3
40	90654	3
51	90655	3
60	90656	3
1/4" TUBE		
12	90661	3
20	90662	3
30	90663	3
40	90664	3
51	90665	3
60	90666	3
*	99941	1

BRAKE LINE ASSORTMENTS

99942 5/16 BRAKE LINE RACK

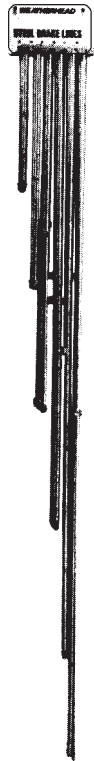

CD-401

5/16" STEEL BRAKE LINE TUBING

5/16" TUBE		
LENGTH	PART #	QTY.
12	90671	3
20	90672	3
30	90673	3
40	90674	3
51	90675	3
60	90676	3
*	99942	1

BRAKE LINE ASSORTMENTS

99943 3/8 BRAKE LINE RACK

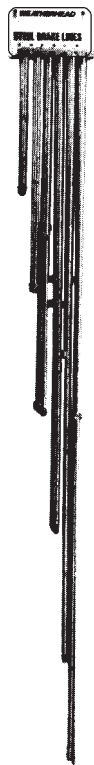

CD-402

3/8" STEEL BRAKE LINE TUBING

3/8" TUBE		
LENGTH	PART #	QTY.
12	90681	3
20	90682	3
30	90683	3
40	90684	3
51	90685	3
60	90686	3
*	99943	1

Fuel Hose Assortment CD-405

Comes complete with a 99940 two bar hose rack.

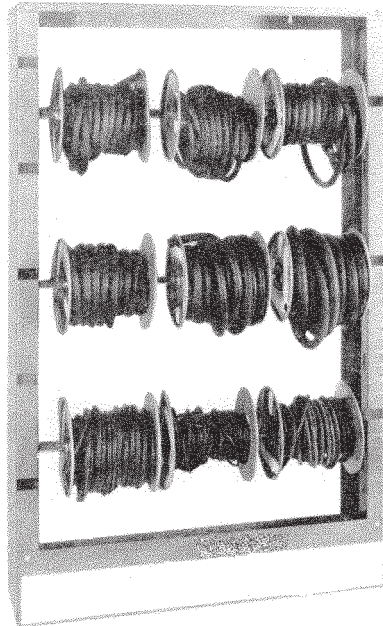

FUEL HOSE		
SIZE	CHOICE #	Qty.
1/4	2201	1
5/16	2203	1
3/8	2204	1
7/16	2205	1
*	99940	1

Vacuum Hose Assortment CD-406

Comes complete with a 99940 two bar hose rack.

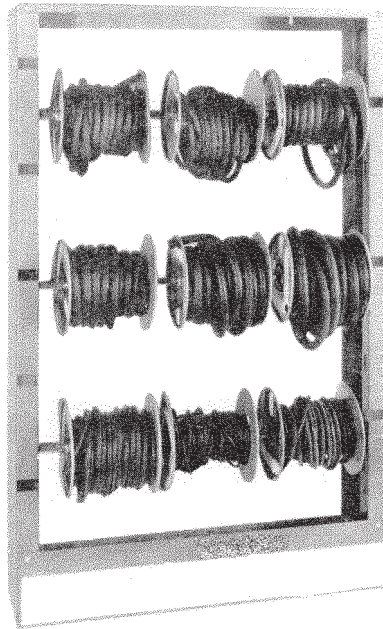

VACUUM HOSE		
SIZE	CHOICE #	Qty.
1/8	2210	1
5/32	2211	1
7/32	2212	1
*	99940	1

Fuel Hose & Vacuum Hose Assortment CD-407

Comes complete with a 99913 three bar hose rack.

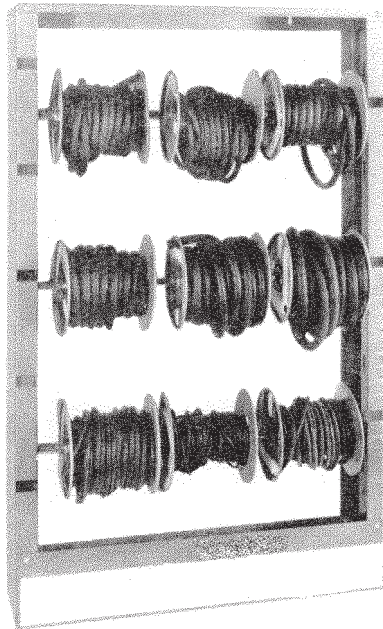

FUEL HOSE		
SIZE	CHOICE #	Qty.
1/4	2201	1
5/16	2203	1
3/8	2204	1
7/16	2205	1
VACUUM HOSE		
1/8	2210	1
5/32	2211	1
7/32	2212	1
*	99913	1





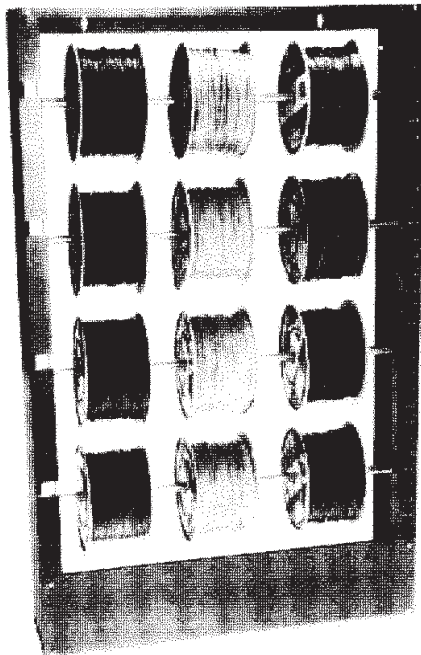









Primary Wire Assortment CD-410

99913 4 BAR HOSE & WIRE RACK



GAUGE	PART #	COLOR
18	58411	RED
18	58412	WHITE
16	58432	RED
16	58433	WHITE
16	58434	BLUE
14	58451	RED
14	58452	WHITE
12	58471	RED
12	58472	WHITE
*	99913	*

CD - 464 Keenserts
99905 Adjustable Space Tray

CHOICE DISTRIBUTION	CD-464 KEENSERTS [®]		111 BELL STREET W. BABYLON, NY 11704 (516) 756-0120
<p>2550</p>  <p>1/4"-20 w/Single Pin Installation Tool (Use Q Drill Dia.)</p> <p>w/ 3/8-16</p>	<p>1</p>  <p>2591 1/4" Keensert Tool</p> <p>1</p>  <p>2592 5/16" Keensert Tool</p> <p>1</p>  <p>2593 3/8" Keensert Tool</p>	<p>1</p>  <p>2594 7/16" Keensert Tool</p> <p>1</p>  <p>2595 1/2" Keensert Tool</p>	<p>5</p>  <p>2551</p> <p>1/4"-28 w/Single Pin Installation Tool (Use Q Drill Dia.)</p> <p>w/ 3/8-16</p>
<p>2552</p>  <p>5/16"-18 w/Single Pin Installation Tool (Use X Drill Dia.)</p> <p>w/ 7/16-14</p>	<p>2558</p>  <p>1/2"-13 w/Single Pin Installation Tool (Use 37/64" Drill Dia.) w/ 5/8-11</p>	<p>2559</p>  <p>1/2"-20 w/Single Pin Installation Tool (Use 37/64" Drill Dia.) w/ 5/8-11</p>	<p>2553</p>  <p>5/16"-24 w/Single Pin Installation Tool (Use X Drill Dia.)</p> <p>w/ 7/16-14</p>
<p>2554</p>  <p>3/8"-16 w/Single Pin Installation Tool (Use 29/64" Drill Dia.)</p> <p>w/ 1/2-13</p>	<p>2556</p>  <p>7/16"-14 w/Single Pin Installation Tool (Use 33/64" Drill Dia.) w/ 9/16-12</p>	<p>2557</p>  <p>7/16"-20 w/Single Pin Installation Tool (Use 33/64" Drill Dia.) w/ 9/16-12</p>	<p>2555</p>  <p>3/8"-24 w/Single Pin Installation Tool (Use 29/64" Drill Dia.)</p> <p>w/ 1/2-13</p>

USS GRADE 5

1/4 TO 1/2



CD - 501

ASSORTMENTS INCLUDES A 40 BIN (99927)

Label Sets Required:

LB-901 GR5 USS Cap Screws

LB-910 GR5 USS Hex Nuts

LB-907 Lockwasher

LB-904 SAE Flatwasher

31651 Nut 1/4 100 Pieces	31751 L. Washer 1/4 100 Pieces	31701 Washer 1/4 200 Pieces	31000 1/4 x 1/2 20 Pieces	31002 1/4 x 3/4 20 Pieces	31003 1/4 x 1 20 Pieces	31004 1/4 x 1 1/4 20 Pieces	31005 1/4 x 1 1/2 20 Pieces
31652 Nut 5/16 100 Pieces	31752 L. Washer 5/16 100 Pieces	31702 Washer 5/16 200 Pieces	31027 5/16 x 3/4 20 Pieces	31029 5/16 x 1 20 Pieces	31030 5/16 x 1 1/4 20 Pieces	31031 5/16 x 1 1/2 20 Pieces	31033 5/16 x 2 20 Pieces
31653 Nut 3/8 100 Pieces	31753 L. Washer 3/8 100 Pieces	31703 Washer 3/8 100 Pieces	31052 3/8 x 3/4 20 Pieces	31054 3/8 x 1 20 Pieces	31055 3/8 x 1 1/4 20 Pieces	31056 3/8 x 1 1/2 20 Pieces	31058 3/8 x 2 20 Pieces
31654 Nut 7/16 50 Pieces	31754 L. Washer 7/16 100 Pieces	31704 Washer 7/16 100 Pieces	31077 7/16 x 3/4 10 Pieces	31079 7/16 x 1 10 Pieces	31081 7/16 x 1 1/2 10 Pieces	31083 7/16 x 2 10 Pieces	31085 7/16 x 2 1/2 10 Pieces
31655 Nut 1/2 50 Pieces	31755 L. Washer 1/2 50 Pieces	31705 Washer 1/2 50 Pieces	31104 1/2 x 1 10 Pieces	31106 1/2 x 1 1/2 10 Pieces	31108 1/2 x 2 10 Pieces	31110 1/2 x 2 1/2 10 Pieces	31112 1/2 x 3 10 Pieces



GRADE 5 1/4 TO 1/2

CD - 502 USS

Assortment includes 72 bin (99908)

Additional equipment:

- S With Stand (99910)
- B With 32 bin (99909)
- SB With both bin & stand

Label Sets Required:

- LB-901 GR5 USS Cap Screws
- LB-910 GR5 USS Hex Nuts
- LB-907 Lockwasher
- LB-904 SAE Flatwasher

31651 Nut 1/4 100 Pieces	31652 Nut 5/16 100 Pieces	31653 Nut 3/8 100 Pieces	31654 Nut 7/16 50 Pieces	31655 Nut 1/2 50 Pieces			
31751 L. Washer 1/4 100 Pieces	31752 L. Washer 5/16 100 Pieces	31753 L. Washer 3/8 100 Pieces	31754 L. Washer 7/16 100 Pieces	31755 L. Washer 1/2 50 Pieces			
31701 Washer 1/4 200 Pieces	31702 Washer 5/16 200 Pieces	31703 Washer 3/8 100 Pieces	31704 Washer 7/16 100 Pieces	31705 Washer 1/2 50 Pieces			
31000 1/4 x 1/2 20 Pieces	31027 5/16 x 3/4 20 Pieces	31052 3/8 x 3/4 20 Pieces	31077 7/16 x 3/4 10 Pieces	31104 1/2 x 1 10 Pieces			
31002 1/4 x 3/4 20 Pieces	31029 5/16 x 1 20 Pieces	31054 3/8 x 1 20 Pieces	31079 7/16 x 1 10 Pieces	31106 1/2 x 1 1/2 10 Pieces			
31003 1/4 x 1 20 Pieces	31030 5/16 x 1 1/4 20 Pieces	31055 3/8 x 1 1/4 20 Pieces	31081 7/16 x 1 1/2 10 Pieces	31108 1/2 x 2 10 Pieces			
31004 1/4 x 1 1/4 20 Pieces	31031 5/16 x 1 1/2 20 Pieces	31056 3/8 x 1 1/2 20 Pieces	31083 7/16 x 2 10 Pieces	31110 1/2 x 2 1/2 10 Pieces			
31005 1/4 x 1 1/2 20 Pieces	31033 5/16 x 2 20 Pieces	31058 3/8 x 2 20 Pieces	31085 7/16 x 2 1/2 10 Pieces	31112 1/2 x 3 10 Pieces			
31007 1/4 x 2 20 Pieces	31035 5/16 x 2 1/2 20 Pieces	31060 3/8 x 2 1/2 20 Pieces	31087 7/16 x 3 10 Pieces	31116 1/2 x 4 10 Pieces			



GRADE 5 1/4 TO 5/8

CD - 503 USS

Assortment includes 72 bin (99908)

Additional equipment:

- S With Stand (99910)
- B With 32 bin (99909)
- SB With both bin & stand

Label Sets Required:

- LB-901 GR5 USS Cap Screws
- LB-910 GR5 USS Hex Nuts
- LB-907 Lockwasher
- LB-904 SAE Flatwasher

31651 Nut 1/4 100 Pieces	31652 Nut 5/16 100 Pieces	31653 Nut 3/8 100 Pieces	31654 Nut 7/16 50 Pieces	31655 Nut 1/2 50 Pieces	31656 Nut 9/16 25 Pieces	31657 Nut 5/8 25 Pieces	
31751 L. Washer 1/4 100 Pieces	31752 L. Washer 5/16 100 Pieces	31753 L. Washer 3/8 100 Pieces	31754 L. Washer 7/16 100 Pieces	31755 L. Washer 1/2 50 Pieces	31756 L. Washer 9/16 50 Pieces	31757 L. Washer 5/8 25 Pieces	
31701 Washer 1/4 200 Pieces	31702 Washer 5/16 200 Pieces	31703 Washer 3/8 100 Pieces	31704 Washer 7/16 100 Pieces	31705 Washer 1/2 50 Pieces	31706 Washer 9/16 25 Pieces	31707 Washer 5/8 25 Pieces	
31000 1/4 x 1/2 20 Pieces	31027 5/16 x 3/4 20 Pieces	31052 3/8 x 3/4 20 Pieces	31077 7/16 x 3/4 10 Pieces	31104 1/2 x 1 10 Pieces	31130 9/16 x 1 10 Pieces	31152 5/8 x 1 1/2 10 Pieces	
31002 1/4 x 3/4 20 Pieces	31029 5/16 x 1 20 Pieces	31054 3/8 x 1 20 Pieces	31079 7/16 x 1 10 Pieces	31106 1/2 x 1 1/2 10 Pieces	31131 9/16 x 1 1/2 10 Pieces	31154 5/8 x 2 5 Pieces	
31003 1/4 x 1 20 Pieces	31030 5/16 x 1 1/4 20 Pieces	31055 3/8 x 1 1/4 20 Pieces	31081 7/16 x 1 1/2 10 Pieces	31108 1/2 x 2 10 Pieces	31133 9/16 x 2 10 Pieces	31156 5/8 x 2 1/2 5 Pieces	
31004 1/4 x 1 1/4 20 Pieces	31031 5/16 x 1 1/2 20 Pieces	31056 3/8 x 1 1/2 20 Pieces	31083 7/16 x 2 10 Pieces	31110 1/2 x 2 1/2 10 Pieces	31135 9/16 x 2 1/2 5 Pieces	31158 5/8 x 3 5 Pieces	
31005 1/4 x 1 1/2 20 Pieces	31033 5/16 x 2 20 Pieces	31058 3/8 x 2 20 Pieces	31085 7/16 x 2 1/2 10 Pieces	31112 1/2 x 3 10 Pieces	31137 9/16 x 3 5 Pieces	31159 5/8 x 3 1/2 5 Pieces	
31007 1/4 x 2 20 Pieces	31035 5/16 x 2 1/2 20 Pieces	31060 3/8 x 2 1/2 20 Pieces	31087 7/16 x 3 10 Pieces	31116 1/2 x 4 10 Pieces	31139 9/16 x 3 1/2 5 Pieces	31160 5/8 x 4 5 Pieces	

SAE GRADE 5

1/4 TO 1/2

CD - 505

ASSORTMENTS INCLUDES A 40 BIN (99927)



Label Sets Required:

LB-902 GR5 SAE Cap Screws

LB-911 GR5 SAE Hex Nuts

LB-907 Lockwasher

LB-904 SAE Flatwasher

31671 Nut 1/4 100 Pieces	31751 L. Washer 1/4 100 Pieces	31701 Washer 1/4 200 Pieces	31301 1/4 x 1/2 20 Pieces	31302 1/4 x 3/4 20 Pieces	31303 1/4 x 1 20 Pieces	31304 1/4 x 1 1/4 20 Pieces	31305 1/4 x 1 1/2 20 Pieces
31672 Nut 5/16 100 Pieces	31752 L. Washer 5/16 100 Pieces	31702 Washer 5/16 200 Pieces	31327 5/16 x 3/4 20 Pieces	31329 5/16 x 1 20 Pieces	31330 5/16 x 1 1/4 20 Pieces	31331 5/16 x 1 1/2 20 Pieces	31333 5/16 x 2 20 Pieces
31673 Nut 3/8 100 Pieces	31753 L. Washer 3/8 100 Pieces	31703 Washer 3/8 100 Pieces	31352 3/8 x 3/4 20 Pieces	31354 3/8 x 1 20 Pieces	31355 3/8 x 1 1/4 20 Pieces	31356 3/8 x 1 1/2 20 Pieces	31358 3/8 x 2 20 Pieces
31674 Nut 7/16 50 Pieces	31754 L. Washer 7/16 100 Pieces	31704 Washer 7/16 100 Pieces	31377 7/16 x 3/4 10 Pieces	31379 7/16 x 1 10 Pieces	31381 7/16 x 1 1/2 10 Pieces	31383 7/16 x 2 10 Pieces	31385 7/16 x 2 1/2 10 Pieces
31675 Nut 1/2 50 Pieces	31755 L. Washer 1/2 50 Pieces	31705 Washer 1/2 50 Pieces	31404 1/2 x 1 10 Pieces	31406 1/2 x 1 1/2 10 Pieces	31408 1/2 x 2 10 Pieces	31410 1/2 x 2 1/2 10 Pieces	31412 1/2 x 3 10 Pieces



GRADE 5 1/4 TO 1/2

CD - 506 SAE

Assortment includes 72 bin (99908)

Additional equipment:

- S With Stand (99910)
- B With 32 bin (99909)
- SB With both bin & stand

Label Sets Required:

- LB-902 GR5 SAE Cap Screws
- LB-911 GR5 SAE Hex Nuts
- LB-907 Lockwasher
- LB-904 SAE Flatwasher

31671 Nut 1/4 100 Pieces	31672 Nut 5/16 100 Pieces	31673 Nut 3/8 100 Pieces	31674 Nut 7/16 50 Pieces	31675 Nut 1/2 50 Pieces			
31751 L. Washer 1/4 100 Pieces	31752 L. Washer 5/16 100 Pieces	31753 L. Washer 3/8 100 Pieces	31754 L. Washer 7/16 100 Pieces	31755 L. Washer 1/2 50 Pieces			
31701 Washer 1/4 200 Pieces	31702 Washer 5/16 200 Pieces	31703 Washer 3/8 100 Pieces	31704 Washer 7/16 100 Pieces	31705 Washer 1/2 50 Pieces			
31301 1/4 x 1/2 20 Pieces	31327 5/16 x 3/4 20 Pieces	31352 3/8 x 3/4 20 Pieces	31377 7/16 x 3/4 10 Pieces	31404 1/2 x 1 10 Pieces			
31302 1/4 x 3/4 20 Pieces	31329 5/16 x 1 20 Pieces	31354 3/8 x 1 20 Pieces	31379 7/16 x 1 10 Pieces	31406 1/2 x 1 1/2 10 Pieces			
31303 1/4 x 1 20 Pieces	31330 5/16 x 1 1/4 20 Pieces	31355 3/8 x 1 1/4 20 Pieces	31381 7/16 x 1 1/2 10 Pieces	31408 1/2 x 2 10 Pieces			
31304 1/4 x 1 1/4 20 Pieces	31331 5/16 x 1 1/2 20 Pieces	31356 3/8 x 1 1/2 20 Pieces	31383 7/16 x 2 10 Pieces	31410 1/2 x 2 1/2 10 Pieces			
31305 1/4 x 1 1/2 20 Pieces	31333 5/16 x 2 20 Pieces	31358 3/8 x 2 20 Pieces	31385 7/16 x 2 1/2 10 Pieces	31412 1/2 x 3 10 Pieces			
31307 1/4 x 2 20 Pieces	31335 5/16 x 2 1/2 20 Pieces	31360 3/8 x 2 1/2 20 Pieces	31387 7/16 x 3 10 Pieces	31416 1/2 x 4 10 Pieces			



GRADE 5 1/4 TO 5/8

CD - 507 SAE

Assortment includes 72 bin (99908)

Additional equipment:

- S With Stand (99910)
- B With 32 bin (99909)
- SB With both bin & stand

Label Sets Required:

- LB-902 GR5 SAE Cap Screws
- LB-911 GR5 SAE Hex Nuts
- LB-907 Lockwasher
- LB-904 SAE Flatwasher

31671 Nut 1/4 100 Pieces	31672 Nut 5/16 100 Pieces	31673 Nut 3/8 100 Pieces	31674 Nut 7/16 50 Pieces	31675 Nut 1/2 50 Pieces	31676 Nut 9/16 25 Pieces	31677 Nut 5/8 25 Pieces	
31751 L. Washer 1/4 100 Pieces	31752 L. Washer 5/16 100 Pieces	31753 L. Washer 3/8 100 Pieces	31754 L. Washer 7/16 100 Pieces	31755 L. Washer 1/2 50 Pieces	31756 L. Washer 9/16 50 Pieces	31757 L. Washer 5/8 25 Pieces	
31701 Washer 1/4 200 Pieces	31702 Washer 5/16 200 Pieces	31703 Washer 3/8 100 Pieces	31704 Washer 7/16 100 Pieces	31705 Washer 1/2 50 Pieces	31706 Washer 9/16 25 Pieces	31707 Washer 5/8 25 Pieces	
31301 1/4 x 1/2 20 Pieces	31327 5/16 x 3/4 20 Pieces	31352 3/8 x 3/4 20 Pieces	31377 7/16 x 3/4 10 Pieces	31404 1/2 x 1 10 Pieces	31430 9/16 x 1 10 Pieces	31452 5/8 x 1 1/2 10 Pieces	
31302 1/4 x 3/4 20 Pieces	31329 5/16 x 1 20 Pieces	31354 3/8 x 1 20 Pieces	31379 7/16 x 1 10 Pieces	31406 1/2 x 1 1/2 10 Pieces	31431 9/16 x 1 1/2 10 Pieces	31454 5/8 x 2 5 Pieces	
31303 1/4 x 1 20 Pieces	31330 5/16 x 1 1/4 20 Pieces	31355 3/8 x 1 1/4 20 Pieces	31381 7/16 x 1 1/2 10 Pieces	31408 1/2 x 2 10 Pieces	31433 9/16 x 2 10 Pieces	31456 5/8 x 2 1/2 5 Pieces	
31304 1/4 x 1 1/4 20 Pieces	31331 5/16 x 1 1/2 20 Pieces	31356 3/8 x 1 1/2 20 Pieces	31383 7/16 x 2 10 Pieces	31410 1/2 x 2 1/2 10 Pieces	31435 9/16 x 2 1/2 5 Pieces	31458 5/8 x 3 5 Pieces	
31305 1/4 x 1 1/2 20 Pieces	31333 5/16 x 2 20 Pieces	31358 3/8 x 2 20 Pieces	31385 7/16 x 2 1/2 10 Pieces	31412 1/2 x 3 10 Pieces	31437 9/16 x 3 5 Pieces	31459 5/8 x 3 1/2 5 Pieces	
31307 1/4 x 2 20 Pieces	31335 5/16 x 2 1/2 20 Pieces	31360 3/8 x 2 1/2 20 Pieces	31387 7/16 x 3 10 Pieces	31416 1/2 x 4 10 Pieces	31439 9/16 x 3 1/2 5 Pieces	31460 5/8 x 4 5 Pieces	



GRADE 5 1/4 TO 3/4

CD - 508 USS

Assortment includes 72 bin (99908)

Additional equipment:

- S With Stand (99910)
- B With 32 bin (99909)
- SB With both bin & stand

Label Sets Required:

- LB-901 GR5 USS Cap Screws
- LB-910 GR5 USS Hex Nuts
- LB-907 Lockwasher
- LB-904 SAE Flatwasher

31651 Nut 1/4 100 Pieces	31652 Nut 5/16 100 Pieces	31653 Nut 3/8 100 Pieces	31654 Nut 7/16 50 Pieces	31655 Nut 1/2 50 Pieces	31656 Nut 9/16 25 Pieces	31657 Nut 5/8 25 Pieces	31658 Nut 3/4 25 Pieces
31751 L. Washer 1/4 100 Pieces	31752 L. Washer 5/16 100 Pieces	31753 L. Washer 3/8 100 Pieces	31754 L. Washer 7/16 100 Pieces	31755 L. Washer 1/2 50 Pieces	31756 L. Washer 9/16 50 Pieces	31757 L. Washer 5/8 25 Pieces	31758 L. Washer 3/4 25 Pieces
31701 Washer 1/4 200 Pieces	31702 Washer 5/16 200 Pieces	31703 Washer 3/8 100 Pieces	31704 Washer 7/16 100 Pieces	31705 Washer 1/2 50 Pieces	31706 Washer 9/16 25 Pieces	31707 Washer 5/8 25 Pieces	31708 Washer 3/4 25 Pieces
31000 1/4 x 1/2 20 Pieces	31027 5/16 x 3/4 20 Pieces	31052 3/8 x 3/4 20 Pieces	31077 7/16 x 3/4 10 Pieces	31104 1/2 x 1 10 Pieces	31130 9/16 x 1 10 Pieces	31152 5/8 x 1 1/2 10 Pieces	31169 3/4 x 2 10 Pieces
31002 1/4 x 3/4 20 Pieces	31029 5/16 x 1 20 Pieces	31054 3/8 x 1 20 Pieces	31079 7/16 x 1 10 Pieces	31106 1/2 x 1 1/2 10 Pieces	31131 9/16 x 1 1/2 10 Pieces	31154 5/8 x 2 5 Pieces	31172 3/4 x 2 1/2 10 Pieces
31003 1/4 x 1 20 Pieces	31030 5/16 x 1 1/4 20 Pieces	31055 3/8 x 1 1/4 20 Pieces	31081 7/16 x 1 1/2 10 Pieces	31108 1/2 x 2 10 Pieces	31133 9/16 x 2 10 Pieces	31156 5/8 x 2 1/2 5 Pieces	31174 3/4 x 3 5 Pieces
31004 1/4 x 1 1/4 20 Pieces	31031 5/16 x 1 1/2 20 Pieces	31056 3/8 x 1 1/2 20 Pieces	31083 7/16 x 2 10 Pieces	31110 1/2 x 2 1/2 10 Pieces	31135 9/16 x 2 1/2 5 Pieces	31158 5/8 x 3 5 Pieces	31174-1 3/4 x 3 1/2 5 Pieces
31005 1/4 x 1 1/2 20 Pieces	31033 5/16 x 2 20 Pieces	31058 3/8 x 2 20 Pieces	31085 7/16 x 2 1/2 10 Pieces	31112 1/2 x 3 10 Pieces	31137 9/16 x 3 5 Pieces	31159 5/8 x 3 1/2 5 Pieces	31175 3/4 x 4 5 Pieces
31007 1/4 x 2 20 Pieces	31035 5/16 x 2 1/2 20 Pieces	31060 3/8 x 2 1/2 20 Pieces	31087 7/16 x 3 10 Pieces	31116 1/2 x 4 10 Pieces	31139 9/16 x 3 1/2 5 Pieces	31160 5/8 x 4 5 Pieces	31176 3/4 x 4 1/2 5 Pieces



GRADE 5 1/4 TO 3/4

CD - 509 SAE

Assortment includes 72 bin (99908)

Additional equipment:

- S With Stand (99910)
- B With 32 bin (99909)
- SB With both bin & stand

Label Sets Required:

- LB-902 GR5 SAE Cap Screws
- LB-911 GR5 SAE Hex Nuts
- LB-907 Lockwasher
- LB-904 SAE Flatwasher

31671 Nut 1/4 100 Pieces	31672 Nut 5/16 100 Pieces	31673 Nut 3/8 100 Pieces	31674 Nut 7/16 50 Pieces	31675 Nut 1/2 50 Pieces	31676 Nut 9/16 25 Pieces	31677 Nut 5/8 25 Pieces	31678 Nut 3/4 25 Pieces
31751 L. Washer 1/4 100 Pieces	31752 L. Washer 5/16 100 Pieces	31753 L. Washer 3/8 100 Pieces	31754 L. Washer 7/16 100 Pieces	31755 L. Washer 1/2 50 Pieces	31756 L. Washer 9/16 50 Pieces	31757 L. Washer 5/8 25 Pieces	31758 L. Washer 3/4 25 Pieces
31701 Washer 1/4 200 Pieces	31702 Washer 5/16 200 Pieces	31703 Washer 3/8 100 Pieces	31704 Washer 7/16 100 Pieces	31705 Washer 1/2 50 Pieces	31706 Washer 9/16 25 Pieces	31707 Washer 5/8 25 Pieces	31708 Washer 3/4 25 Pieces
31301 1/4 x 1/2 20 Pieces	31327 5/16 x 3/4 20 Pieces	31352 3/8 x 3/4 20 Pieces	31377 7/16 x 3/4 10 Pieces	31404 1/2 x 1 10 Pieces	31430 9/16 x 1 10 Pieces	31452 5/8 x 1 1/2 10 Pieces	31469 3/4 x 2 10 Pieces
31302 1/4 x 3/4 20 Pieces	31329 5/16 x 1 20 Pieces	31354 3/8 x 1 20 Pieces	31379 7/16 x 1 10 Pieces	31406 1/2 x 1 1/2 10 Pieces	31431 9/16 x 1 1/2 10 Pieces	31454 5/8 x 2 5 Pieces	31472 3/4 x 2 1/2 10 Pieces
31303 1/4 x 1 20 Pieces	31330 5/16 x 1 1/4 20 Pieces	31355 3/8 x 1 1/4 20 Pieces	31381 7/16 x 1 1/2 10 Pieces	31408 1/2 x 2 10 Pieces	31433 9/16 x 2 10 Pieces	31456 5/8 x 2 1/2 5 Pieces	31474 3/4 x 3 5 Pieces
31304 1/4 x 1 1/4 20 Pieces	31331 5/16 x 1 1/2 20 Pieces	31356 3/8 x 1 1/2 20 Pieces	31383 7/16 x 2 10 Pieces	31410 1/2 x 2 1/2 10 Pieces	31435 9/16 x 2 1/2 5 Pieces	31458 5/8 x 3 5 Pieces	31475 3/4 x 3 1/2 5 Pieces
31305 1/4 x 1 1/2 20 Pieces	31333 5/16 x 2 20 Pieces	31358 3/8 x 2 20 Pieces	31385 7/16 x 2 1/2 10 Pieces	31412 1/2 x 3 10 Pieces	31437 9/16 x 3 5 Pieces	31459 5/8 x 3 1/2 5 Pieces	31475-1 3/4 x 4 5 Pieces
31307 1/4 x 2 20 Pieces	31335 5/16 x 2 1/2 20 Pieces	31360 3/8 x 2 1/2 20 Pieces	31387 7/16 x 3 10 Pieces	31416 1/2 x 4 10 Pieces	31439 9/16 x 3 1/2 5 Pieces	31460 5/8 x 4 5 Pieces	31476 3/4 x 4 1/2 5 Pieces

CAP SCREW ASSORTMENTS

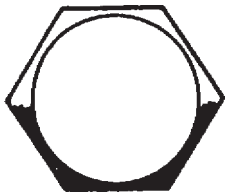

18.8 STAINLESS STEEL

1/4 TO 1/2

CD - 511 USS

Assortment includes 72 bin (99908)

Additional equipment:

- S With Stand (99910)
- B With 32 bin (99909)
- SB With both bin & stand

Label Sets Required:

LB-928 SS 318 Cap Screws, Nuts, Flats, Locks

60601 Hex Nuts 1/4 50 Pieces	60602 Hex Nuts 5/16 50 Pieces	60603 Hex Nuts 3/8 50 Pieces	60605 Hex Nuts 1/2 25 Pieces				
60701 Washers 1/4 50 Pieces	60702 Washers 5/16 50 Pieces	60703 Washers 3/8 50 Pieces	60705 Washers 1/2 25 Pieces				
60751 Lock 1/4 100	60752 Lock 5/16 100	60753 Lock 3/8 100 Pieces	60755 Lock 1/2 50 Pieces				
60000 CS 1/4 x 1/2 20 Pieces	60027 CS 5/16 x 3/4 20	60052 CS 3/8 x 3/4 20 Pieces	60104 CS 1/2 x 1 10 Pieces				
60002 CS 1/4 x 3/4 20 Pieces	60029 CS 5/16 x 1 20 Pieces	60054 CS 3/8 x 1 20 Pieces	60106 CS 1/2 x 1 1/2 10 Pieces				
60004 CS 1/4 x 1 20 Pieces	60030 CS 5/16 x 1 1/4 20 Pieces	60055 CS 3/8 x 1 1/4 20 Pieces	60108 CS 1/2 x 2 10 Pieces				
60005 CS 1/4 x 1 1/4 20 Pieces	60031 CS 5/16 x 1 1/2 20 Pieces	60056 CS 3/8 x 1 1/2 20 Pieces	60110 CS 1/2 x 2 1/2 10 Pieces				
60006 CS 1/4 x 1 1/2 20 Pieces	60032 CS 5/16 x 1 3/4 20 Pieces	60058 CS 3/8 x 2 20 Pieces	60112 CS 1/2 x 3 10 Pieces				
60008 CS 1/4 x 2 20 Pieces	60035 CS 5/16 x 2 1/2 20 Pieces	60060 CS 3/8 x 2 1/2 20 Pieces	60116 CS 1/2 x 4 10 Pieces				

CAP SCREW ASSORTMENTS

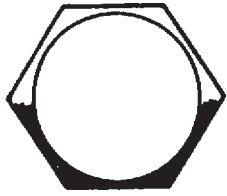

316 STAINLESS STEEL

1/4 TO 3/4

CD - 512 USS

Assortment includes 72 bin (99908)

Additional equipment:

- S With Stand (99910)
- B With 32 bin (99909)
- SB With both bin & stand

Label Sets Required:

LB-926 SS 316 Cap Screws

50601 Hex Nuts 1/4 50 Pieces	50602 Hex Nuts 5/16 50 Pieces	50603 Hex Nuts 3/8 50 Pieces	50605 Hex Nuts 1/2 25 Pieces	50607 Hex Nuts 5/8 10 Pieces	50608 Hex Nuts 3/4 10 Pieces		
50701 Washers 1/4 50 Pieces	50702 Washers 5/16 50 Pieces	50703 Washers 3/8 50 Pieces	50705 Washers 1/2 25 Pieces	50707 Washers 5/8 25 Pieces	50708 Washers 3/4 25 Pieces		
50751 Lock 1/4 100 Pieces	50752 Lock 5/16 100 Pieces	50753 Lock 3/8 100 Pieces	50755 Lock 1/2 50 Pieces	50757 Lock 5/8 25 Pieces	50758 Lock 3/4 10 Pieces		
50000 Cap Screws 1/4 x 1/2 20 Pieces	50027 Cap Screws 5/16 x 3/4 20 Pieces	50052 Cap Screws 3/8 x 3/4 20 Pieces	50104 Cap Screws 1/2 x 1 10 Pieces	50147 Cap Screws 5/8 x 1 1/2 10 Pieces	50170 Cap Screws 3/4 x 1 1/2 10 Pieces		
50002 Cap Screws 1/4 x 3/4 20 Pieces	50029 Cap Screws 5/16 x 1 20 Pieces	50054 Cap Screws 3/8 x 1 20 Pieces	50106 Cap Screws 1/2 x 1 1/2 10 Pieces	50149 Cap Screws 5/8 x 2 5 Pieces	50172 Cap Screws 3/4 x 2 5 Pieces		
50004 Cap Screws 1/4 x 1 20 Pieces	50030 Cap Screws 5/16 x 1 1/4 20 Pieces	50055 Cap Screws 3/8 x 1 1/4 20 Pieces	50108 Cap Screws 1/2 x 2 10 Pieces	50151 Cap Screws 5/8 x 2 1/2 5 Pieces	50174 Cap Screws 3/4 x 2 1/2 5 Pieces		
50005 Cap Screws 1/4 x 1 1/4 20 Pieces	50031 Cap Screws 5/16 x 1 1/2 20 Pieces	50056 Cap Screws 3/8 x 1 1/2 20 Pieces	50110 Cap Screws 1/2 x 2 1/2 10 Pieces	50153 Cap Screws 5/8 x 3 5 Pieces	50176 Cap Screws 3/4 x 3 5 Pieces		
50006 Cap Screws 1/4 x 1 1/2 20 Pieces	50033 Cap Screws 5/16 x 2 20 Pieces	50058 Cap Screws 3/8 x 2 20 Pieces	50112 Cap Screws 1/2 x 3 10 Pieces	50155 Cap Screws 5/8 x 3 1/2 5 Pieces	50178 Cap Screws 3/4 x 3 1/2 5 Pieces		
50008 Cap Screws 1/4 x 2 20 Pieces	50035 Cap Screws 5/16 x 2 1/2 20 Pieces	50060 Cap Screws 3/8 x 2 1/2 20 Pieces	50116 Cap Screws 1/2 x 4 10 Pieces	50157 Cap Screws 5/8 x 4 5 Pieces	50180 Cap Screws 3/4 x 4 5 Pieces		

USS GRADE 8

1/4 TO 1/2

CD - 521

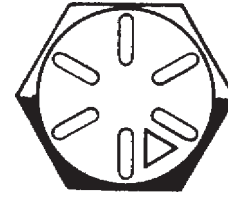

ASSORTMENTS INCLUDES A 40 BIN (99927)

Label Sets Required:

LB-912 GR8 USS Cap Screws

LB-905 USS Hex Nuts

LB-907 Lockwasher

LB-904 SAE Flatwasher

40601 NUT 1/4 100 Pieces	40751 LOCK 1/4 100 Pieces	40701 Washer 1/4 200 Pieces	40000 1/4 x 1/2 20 Pieces	40002 1/4 x 3/4 20 Pieces	40004 1/4 x 1 20 Pieces	40005 1/4 x 1 1/4 20 Pieces	40006 1/4 x 1 1/2 20 Pieces
40602 NUT 5/16 100 Pieces	40752 LOCK 5/16 100 Pieces	40702 Washer 5/16 200 Pieces	40027 5/16 x 3/4 20 Pieces	40029 5/16 x 1 20 Pieces	40030 5/16 x 1 1/4 20 Pieces	40031 5/16 x 1 1/2 20 Pieces	40033 5/16 x 2 20 Pieces
40603 NUT 3/8 100 Pieces	40753 LOCK 3/8 100 Pieces	40703 Washer 3/8 100 Pieces	40054 3/8 x 1 20 Pieces	40055 3/8 x 1 1/4 20 Pieces	40056 3/8 x 1 1/2 20 Pieces	40058 3/8 x 2 20 Pieces	40060 3/8 x 2 1/2 20 Pieces
40604 NUT 7/16 50 Pieces	40754 LOCK 7/16 100 Pieces	40704 Washer 7/16 100 Pieces	40077 7/16 x 3/4 10 Pieces	40079 7/16 x 1 10 Pieces	40081 7/16 x 1 1/2 10 Pieces	40083 7/16 x 2 10 Pieces	40085 7/16 x 2 1/2 10 Pieces
40605 NUT 1/2 50 Pieces	40755 LOCK 1/2 50 Pieces	40705 Washer 1/2 50 Pieces	40104 1/2 x 1 10 Pieces	40106 1/2 x 1 1/2 10 Pieces	40108 1/2 x 2 10 Pieces	40110 1/2 x 2 1/2 10 Pieces	40112 1/2 x 3 10 Pieces



GRADE 8 1/4 TO 1/2

CD - 522 USS

Assortment includes 72 bin (99908)

Additional equipment:

- S With Stand (99910)
- B With 32 bin (99909)
- SB With both bin & stand

Label Sets Required:

- LB-912 GR8 USS Cap Screws
- LB-905 USS Hex Nuts
- LB-907 Lockwasher
- LB-904 SAE Flatwasher

40601 NUT 1/4 100 Pieces	40602 NUT 5/16 100 Pieces	40603 NUT 3/8 100 Pieces	40604 NUT 7/16 50 Pieces	40605 NUT 1/2 50 Pieces			
40751 LOCK 1/4 100 Pieces	40752 LOCK 5/16 100 Pieces	40753 LOCK 3/8 100 Pieces	40754 LOCK 7/16 100 Pieces	40755 LOCK 1/2 50 Pieces			
40701 Washer 1/4 200 Pieces	40702 Washer 5/16 200 Pieces	40703 Washer 3/8 100 Pieces	40704 Washer 7/16 100 Pieces	40705 Washer 1/2 50 Pieces			
40000 1/4 x 1/2 20 Pieces	40027 5/16 x 3/4 20 Pieces	40054 3/8 x 1 20 Pieces	40077 7/16 x 3/4 10 Pieces	40104 1/2 x 1 10 Pieces			
40002 1/4 x 3/4 20 Pieces	40029 5/16 x 1 20 Pieces	40055 3/8 x 1 1/4 20 Pieces	40079 7/16 x 1 10 Pieces	40106 1/2 x 1 1/2 10 Pieces			
40004 1/4 x 1 20 Pieces	40030 5/16 x 1 1/4 20 Pieces	40056 3/8 x 1 1/2 20 Pieces	40081 7/16 x 1 1/2 10 Pieces	40108 1/2 x 2 10 Pieces			
40005 1/4 x 1 1/4 20 Pieces	40031 5/16 x 1 1/2 20 Pieces	40058 3/8 x 2 20 Pieces	40083 7/16 x 2 10 Pieces	40110 1/2 x 2 1/2 10 Pieces			
40006 1/4 x 1 1/2 20 Pieces	40033 5/16 x 2 20 Pieces	40060 3/8 x 2 1/2 20 Pieces	40085 7/16 x 2 1/2 10 Pieces	40112 1/2 x 3 10 Pieces			
40008 1/4 x 2 20 Pieces	40035 5/16 x 2 1/2 20 Pieces	40062 3/8 x 3 20 Pieces	40087 7/16 x 3 10 Pieces	40116 1/2 x 4 10 Pieces			

SAE GRADE 8

1/4 TO 1/2

CD - 525



ASSORTMENTS INCLUDES A 40 BIN (99927)

Label Sets Required:

LB-913 GR8 SAE Cap Screws

LB-906 SAE Hex Nuts

LB-907 Lockwasher

LB-903 USS Flatwasher

40621 NUT 1/4 100 Pieces	40751 LOCK 1/4 100 Pieces	40721 Washer 1/4 200 Pieces	40300 1/4 x 1/2 20 Pieces	40302 1/4 x 3/4 20 Pieces	40304 1/4 x 1 20 Pieces	40305 1/4 x 1 1/4 20 Pieces	40306 1/4 x 1 1/2 20 Pieces
40622 NUT 5/16 100 Pieces	40752 LOCK 5/16 100 Pieces	40722 Washer 5/16 200 Pieces	40327 5/16 x 3/4 20 Pieces	40329 5/16 x 1 20 Pieces	40330 5/16 x 1 1/4 20 Pieces	40331 5/16 x 1 1/2 20 Pieces	40333 5/16 x 2 20 Pieces
40623 NUT 3/8 100 Pieces	40753 LOCK 3/8 100 Pieces	40723 Washer 3/8 100 Pieces	40354 3/8 x 1 20 Pieces	40355 3/8 x 1 1/4 20 Pieces	40356 3/8 x 1 1/2 20 Pieces	40358 3/8 x 2 20 Pieces	40360 3/8 x 2 1/2 20 Pieces
40624 NUT 7/16 50 Pieces	40754 LOCK 7/16 100 Pieces	40724 Washer 7/16 100 Pieces	40377 7/16 x 3/4 10 Pieces	40379 7/16 x 1 10 Pieces	40381 7/16 x 1 1/2 10 Pieces	40383 7/16 x 2 10 Pieces	40385 7/16 x 2 1/2 10 Pieces
40625 NUT 1/2 50 Pieces	40755 LOCK 1/2 50 Pieces	40725 Washer 1/2 50 Pieces	40404 1/2 x 1 10 Pieces	40406 1/2 x 1 1/2 10 Pieces	40408 1/2 x 2 10 Pieces	40410 1/2 x 2 1/2 10 Pieces	40412 1/2 x 3 10 Pieces



GRADE 8 1/4 TO 1/2

CD - 526 SAE

Assortment includes 72 bin (99908)

Additional equipment:

- S With Stand (99910)
- B With 32 bin (99909)
- SB With both bin & stand

Label Sets Required:

- LB-913 GR8 SAE Cap Screws
- LB-906 SAE Hex Nuts
- LB-907 Lockwasher
- LB-903 USS Flatwasher

40621 NUT 1/4 100 Pieces	40622 NUT 5/16 100 Pieces	40623 NUT 3/8 100 Pieces	40624 NUT 7/16 50 Pieces	40625 NUT 1/2 50 Pieces			
40751 LOCK 1/4 100 Pieces	40752 LOCK 5/16 100 Pieces	40753 LOCK 3/8 100 Pieces	40754 LOCK 7/16 100 Pieces	40755 LOCK 1/2 50 Pieces			
40721 Washer 1/4 200 Pieces	40722 Washer 5/16 200 Pieces	40723 Washer 3/8 100 Pieces	40724 Washer 7/16 100 Pieces	40725 Washer 1/2 50 Pieces			
40300 1/4 x 1/2 20 Pieces	40327 5/16 x 3/4 20 Pieces	40354 3/8 x 1 20 Pieces	40377 7/16 x 3/4 10 Pieces	40404 1/2 x 1 10 Pieces			
40302 1/4 x 3/4 20 Pieces	40329 5/16 x 1 20 Pieces	40355 3/8 x 1 1/4 20 Pieces	40379 7/16 x 1 10 Pieces	40406 1/2 x 1 1/2 10 Pieces			
40304 1/4 x 1 20 Pieces	40330 5/16 x 1 1/4 20 Pieces	40356 3/8 x 1 1/2 20 Pieces	40381 7/16 x 1 1/2 10 Pieces	40408 1/2 x 2 10 Pieces			
40305 1/4 x 1 1/4 20 Pieces	40331 5/16 x 1 1/2 20 Pieces	40358 3/8 x 2 20 Pieces	40383 7/16 x 2 10 Pieces	40410 1/2 x 2 1/2 10 Pieces			
40306 1/4 x 1 1/2 20 Pieces	40333 5/16 x 2 20 Pieces	40360 3/8 x 2 1/2 20 Pieces	40385 7/16 x 2 1/2 10 Pieces	40412 1/2 x 3 10 Pieces			
40308 1/4 x 2 20 Pieces	40335 5/16 x 2 1/2 20 Pieces	40362 3/8 x 3 20 Pieces	40387 7/16 x 3 10 Pieces	40416 1/2 x 4 10 Pieces			



GRADE 8 1/4 TO 5/8

CD - 530 USS

Assortment includes 72 bin (99908)

Additional equipment:

- S With Stand (99910)
- B With 32 bin (99909)
- SB With both bin & stand

Label Sets Required:

- LB-912 GR8 USS Cap Screws
- LB-905 USS Hex Nuts
- LB-907 Lockwasher
- LB-904 SAE Flatwasher

40601 NUT 1/4 100 Pieces	40602 NUT 5/16 100 Pieces	40603 NUT 3/8 100 Pieces	40604 NUT 7/16 50 Pieces	40605 NUT 1/2 50 Pieces	40606 NUT 9/16 25 Pieces	40607 NUT 5/8 25 Pieces	
40751 LOCK 1/4 100 Pieces	40752 LOCK 5/16 100 Pieces	40753 LOCK 3/8 100 Pieces	40754 LOCK 7/16 100 Pieces	40755 LOCK 1/2 50 Pieces	40756 LOCK 9/16 50 Pieces	40757 LOCK 5/8 25 Pieces	
40701 Washer 1/4 200 Pieces	40702 Washer 5/16 200 Pieces	40703 Washer 3/8 100 Pieces	40704 Washer 7/16 100 Pieces	40705 Washer 1/2 50 Pieces	40706 Washer 9/16 25 Pieces	40707 Washer 5/8 25 Pieces	
40000 1/4 x 1/2 20 Pieces	40027 5/16 x 3/4 20 Pieces	40054 3/8 x 1 20 Pieces	40077 7/16 x 3/4 10 Pieces	40104 1/2 x 1 10 Pieces	40129 9/16 x 1 10 Pieces	40147 5/8 x 1 1/2 10 Pieces	
40002 1/4 x 3/4 20 Pieces	40029 5/16 x 1 20 Pieces	40055 3/8 x 1 1/4 20 Pieces	40079 7/16 x 1 10 Pieces	40106 1/2 x 1 1/2 10 Pieces	40131 9/16 x 1 1/2 10 Pieces	40149 5/8 x 2 5 Pieces	
40004 1/4 x 1 20 Pieces	40030 5/16 x 1 1/4 20 Pieces	40056 3/8 x 1 1/2 20 Pieces	40081 7/16 x 1 1/2 10 Pieces	40108 1/2 x 2 10 Pieces	40133 9/16 x 2 10 Pieces	40151 5/8 x 2 1/2 5 Pieces	
40005 1/4 x 1 1/4 20 Pieces	40031 5/16 x 1 1/2 20 Pieces	40058 3/8 x 2 20 Pieces	40083 7/16 x 2 10 Pieces	40110 1/2 x 2 1/2 10 Pieces	40135 9/16 x 2 1/2 5 Pieces	40153 5/8 x 3 5 Pieces	
40006 1/4 x 1 1/2 20 Pieces	40033 5/16 x 2 20 Pieces	40060 3/8 x 2 1/2 20 Pieces	40085 7/16 x 2 1/2 10 Pieces	40112 1/2 x 3 10 Pieces	40137 9/16 x 3 5 Pieces	40155 5/8 x 3 1/2 5 Pieces	
40008 1/4 x 2 20 Pieces	40035 5/16 x 2 1/2 20 Pieces	40062 3/8 x 3 20 Pieces	40087 7/16 x 3 10 Pieces	40116 1/2 x 4 10 Pieces	40139 9/16 x 3 1/2 5 Pieces	40157 5/8 x 4 5 Pieces	



GRADE 8 1/4 TO 5/8

CD - 532 SAE

Assortment includes 72 bin (99908)

Additional equipment:

- S With Stand (99910)
- B With 32 bin (99909)
- SB With both bin & stand

Label Sets Required:

- LB-913 GR8 SAE Cap Screws
- LB-906 SAE Hex Nuts
- LB-907 Lockwasher
- LB-903 USS Flatwasher

40621 NUT 1/4 100 Pieces	40622 NUT 5/16 100 Pieces	40623 NUT 3/8 100 Pieces	40624 NUT 7/16 50 Pieces	40625 NUT 1/2 50 Pieces	40626 NUT 9/16 25 Pieces	40627 NUT 5/8 25 Pieces	
40751 LOCK 1/4 100 Pieces	40752 LOCK 5/16 100 Pieces	40753 LOCK 3/8 100 Pieces	40754 LOCK 7/16 100 Pieces	40755 LOCK 1/2 50 Pieces	40756 LOCK 9/16 50 Pieces	40757 LOCK 5/8 25 Pieces	
40721 Washer 1/4 200 Pieces	40722 Washer 5/16 200 Pieces	40723 Washer 3/8 100 Pieces	40724 Washer 7/16 100 Pieces	40725 Washer 1/2 50 Pieces	40726 Washer 9/16 25 Pieces	40727 Washer 5/8 25 Pieces	
40300 1/4 x 1/2 20 Pieces	40327 5/16 x 3/4 20 Pieces	40354 3/8 x 1 20 Pieces	40377 7/16 x 3/4 10 Pieces	40404 1/2 x 1 10 Pieces	40429 9/16 x 1 10 Pieces	40447 5/8 x 1 1/2 10 Pieces	
40302 1/4 x 3/4 20 Pieces	40329 5/16 x 1 20 Pieces	40355 3/8 x 1 1/4 20 Pieces	40379 7/16 x 1 10 Pieces	40406 1/2 x 1 1/2 10 Pieces	40431 9/16 x 1 1/2 10 Pieces	40449 5/8 x 2 5 Pieces	
40304 1/4 x 1 20 Pieces	40330 5/16 x 1 1/4 20 Pieces	40356 3/8 x 1 1/2 20 Pieces	40381 7/16 x 1 1/2 10 Pieces	40408 1/2 x 2 10 Pieces	40433 9/16 x 2 10 Pieces	40451 5/8 x 2 1/2 5 Pieces	
40305 1/4 x 1 1/4 20 Pieces	40331 5/16 x 1 1/2 20 Pieces	40358 3/8 x 2 20 Pieces	40383 7/16 x 2 10 Pieces	40410 1/2 x 2 1/2 10 Pieces	40435 9/16 x 2 1/2 5 Pieces	40453 5/8 x 3 5 Pieces	
40306 1/4 x 1 1/2 20 Pieces	40333 5/16 x 2 20 Pieces	40360 3/8 x 2 1/2 20 Pieces	40385 7/16 x 2 1/2 10 Pieces	40412 1/2 x 3 10 Pieces	40437 9/16 x 3 5 Pieces	40455 5/8 x 3 1/2 5 Pieces	
40308 1/4 x 2 20 Pieces	40335 5/16 x 2 1/2 20 Pieces	40362 3/8 x 3 20 Pieces	40387 7/16 x 3 10 Pieces	40416 1/2 x 4 10 Pieces	40439 9/16 x 3 1/2 5 Pieces	40457 5/8 x 4 5 Pieces	



GRADE 8 1/4 TO 3/4

CD - 534 USS

Assortment includes 72 bin (99908)

Additional equipment:

- S With Stand (99910)
- B With 32 bin (99909)
- SB With both bin & stand

Label Sets Required:

- LB-912 GR8 USS Cap Screws
- LB-905 USS Hex Nuts
- LB-907 Lockwasher
- LB-904 SAE Flatwasher

40601 NUT 1/4 100 Pieces	40602 NUT 5/16 100 Pieces	40603 NUT 3/8 100 Pieces	40604 NUT 7/16 50 Pieces	40605 NUT 1/2 50 Pieces	40606 NUT 9/16 25 Pieces	40607 NUT 5/8 25 Pieces	40608 NUT 3/4 25 Pieces
40751 LOCK 1/4 100 Pieces	40752 LOCK 5/16 100 Pieces	40753 LOCK 3/8 100 Pieces	40754 LOCK 7/16 100 Pieces	40755 LOCK 1/2 50 Pieces	40756 LOCK 9/16 50 Pieces	40757 LOCK 5/8 25 Pieces	40758 LOCK 3/4 25 Pieces
40701 Washer 1/4 200 Pieces	40702 Washer 5/16 200 Pieces	40703 Washer 3/8 100 Pieces	40704 Washer 7/16 100 Pieces	40705 Washer 1/2 50 Pieces	40706 Washer 9/16 25 Pieces	40707 Washer 5/8 25 Pieces	40708 Washer 3/4 25 Pieces
40000 1/4 x 1/2 20 Pieces	40027 5/16 x 3/4 20 Pieces	40054 3/8 x 1 20 Pieces	40077 7/16 x 3/4 10 Pieces	40104 1/2 x 1 10 Pieces	40129 9/16 x 1 10 Pieces	40147 5/8 x 1 1/2 10 Pieces	40172 3/4 x 2 10 Pieces
40002 1/4 x 3/4 20 Pieces	40029 5/16 x 1 20 Pieces	40055 3/8 x 1 1/4 20 Pieces	40079 7/16 x 1 10 Pieces	40106 1/2 x 1 1/2 10 Pieces	40131 9/16 x 1 1/2 10 Pieces	40149 5/8 x 2 5 Pieces	40174 3/4 x 2 1/2 10 Pieces
40004 1/4 x 1 20 Pieces	40030 5/16 x 1 1/4 20 Pieces	40056 3/8 x 1 1/2 20 Pieces	40081 7/16 x 1 1/2 10 Pieces	40108 1/2 x 2 10 Pieces	40133 9/16 x 2 10 Pieces	40151 5/8 x 2 1/2 5 Pieces	40176 3/4 x 3 5 Pieces
40005 1/4 x 1 1/4 20 Pieces	40031 5/16 x 1 1/2 20 Pieces	40058 3/8 x 2 20 Pieces	40083 7/16 x 2 10 Pieces	40110 1/2 x 2 1/2 10 Pieces	40135 9/16 x 2 1/2 5 Pieces	40153 5/8 x 3 5 Pieces	40178 3/4 x 3 1/2 5 Pieces
40006 1/4 x 1 1/2 20 Pieces	40033 5/16 x 2 20 Pieces	40060 3/8 x 2 1/2 20 Pieces	40085 7/16 x 2 1/2 10 Pieces	40112 1/2 x 3 10 Pieces	40137 9/16 x 3 5 Pieces	40155 5/8 x 3 1/2 5 Pieces	40180 3/4 x 4 5 Pieces
40008 1/4 x 2 20 Pieces	40035 5/16 x 2 1/2 20 Pieces	40062 3/8 x 3 20 Pieces	40087 7/16 x 3 10 Pieces	40116 1/2 x 4 10 Pieces	40139 9/16 x 3 1/2 5 Pieces	40157 5/8 x 4 5 Pieces	40181 3/4 x 4 1/2 5 Pieces



GRADE 8 1/4 TO 3/4

CD - 535 SAE

Assortment includes 72 bin (99908)

Additional equipment:

- S With Stand (99910)
- B With 32 bin (99909)
- SB With both bin & stand

Label Sets Required:

- LB-913 GR8 SAE Cap Screws
- LB-906 SAE Hex Nuts
- LB-907 Lockwasher
- LB-903 USS Flatwasher

40621 NUT 1/4 100 Pieces	40622 NUT 5/16 100 Pieces	40623 NUT 3/8 100 Pieces	40624 NUT 7/16 50 Pieces	40625 NUT 1/2 50 Pieces	40626 NUT 9/16 25 Pieces	40627 NUT 5/8 25 Pieces	40628 NUT 3/4 25 Pieces
40751 LOCK 1/4 100 Pieces	40752 LOCK 5/16 100 Pieces	40753 LOCK 3/8 100 Pieces	40754 LOCK 7/16 100 Pieces	40755 LOCK 1/2 50 Pieces	40756 LOCK 9/16 50 Pieces	40757 LOCK 5/8 25 Pieces	40758 LOCK 3/4 25 Pieces
40721 Washer 1/4 200 Pieces	40722 Washer 5/16 200 Pieces	40723 Washer 3/8 100 Pieces	40724 Washer 7/16 100 Pieces	40725 Washer 1/2 50 Pieces	40726 Washer 9/16 25 Pieces	40727 Washer 5/8 25 Pieces	40728 Washer 3/4 25 Pieces
40300 1/4 x 1/2 20 Pieces	40327 5/16 x 3/4 20 Pieces	40354 3/8 x 1 20 Pieces	40377 7/16 x 3/4 10 Pieces	40404 1/2 x 1 10 Pieces	40429 9/16 x 1 10 Pieces	40447 5/8 x 1 1/2 10 Pieces	40472 3/4 x 2 10 Pieces
40302 1/4 x 3/4 20 Pieces	40329 5/16 x 1 20 Pieces	40355 3/8 x 1 1/4 20 Pieces	40379 7/16 x 1 10 Pieces	40406 1/2 x 1 1/2 10 Pieces	40431 9/16 x 1 1/2 10 Pieces	40449 5/8 x 2 5 Pieces	40474 3/4 x 2 1/2 10 Pieces
40304 1/4 x 1 20 Pieces	40330 5/16 x 1 1/4 20 Pieces	40356 3/8 x 1 1/2 20 Pieces	40381 7/16 x 1 1/2 10 Pieces	40408 1/2 x 2 10 Pieces	40433 9/16 x 2 10 Pieces	40451 5/8 x 2 1/2 5 Pieces	40476 3/4 x 3 5 Pieces
40305 1/4 x 1 1/4 20 Pieces	40331 5/16 x 1 1/2 20 Pieces	40358 3/8 x 2 20 Pieces	40383 7/16 x 2 10 Pieces	40410 1/2 x 2 1/2 10 Pieces	40435 9/16 x 2 1/2 5 Pieces	40453 5/8 x 3 5 Pieces	40478 3/4 x 3 1/2 5 Pieces
40306 1/4 x 1 1/2 20 Pieces	40333 5/16 x 2 20 Pieces	40360 3/8 x 2 1/2 20 Pieces	40385 7/16 x 2 1/2 10 Pieces	40412 1/2 x 3 10 Pieces	40437 9/16 x 3 5 Pieces	40455 5/8 x 3 1/2 5 Pieces	40480 3/4 x 4 5 Pieces
40308 1/4 x 2 20 Pieces	40335 5/16 x 2 1/2 20 Pieces	40362 3/8 x 3 20 Pieces	40387 7/16 x 3 10 Pieces	40416 1/2 x 4 10 Pieces	40439 9/16 x 3 1/2 5 Pieces	40457 5/8 x 4 5 Pieces	40481 3/4 x 4 1/2 5 Pieces



CD 180 1/4 TO 1/2

CD - 542 (USS)

Assortment includes 72 bin (99908)

Additional equipment:

- S With Stand (99910)
- B With 32 bin (99909)
- SB With both bin & stand

Label Sets Required:

- LB-921 Choice 180 USS Cap Screws
- LB-905 USS Hex Nuts
- LB-907 Lockwasher
- LB-904 SAE Flatwasher

37601 NUT 1/4 100 Pieces	37602 NUT 5/16 100 Pieces	37603 NUT 3/8 100 Pieces	37604 NUT 7/16 50 Pieces	37605 NUT 1/2 50 Pieces			
37751 LOCK 1/4 100 Pieces	37752 LOCK 5/16 100 Pieces	37753 LOCK 3/8 100 Pieces	37754 LOCK 7/16 100 Pieces	37755 LOCK 1/2 50 Pieces			
40701 Washer 1/4 200 Pieces	40702 Washer 5/16 200 Pieces	40703 Washer 3/8 100 Pieces	40704 Washer 7/16 100 Pieces	40705 Washer 1/2 50 Pieces			
37000 1/4 x 1/2 20 Pieces	37027 5/16 x 3/4 20 Pieces	37054 3/8 x 1 20 Pieces	37077 7/16 x 3/4 10 Pieces	37104 1/2 x 1 10 Pieces			
37002 1/4 x 3/4 20 Pieces	37029 5/16 x 1 20 Pieces	37055 3/8 x 1 1/4 20 Pieces	37079 7/16 x 1 10 Pieces	37106 1/2 x 1 1/2 10 Pieces			
37004 1/4 x 1 20 Pieces	37030 5/16 x 1 1/4 20 Pieces	37056 3/8 x 1 1/2 20 Pieces	37081 7/16 x 1 1/2 10 Pieces	37108 1/2 x 2 10 Pieces			
37005 1/4 x 1 1/4 20 Pieces	37031 5/16 x 1 1/2 20 Pieces	37058 3/8 x 2 20 Pieces	37083 7/16 x 2 10 Pieces	37110 1/2 x 2 1/2 10 Pieces			
37006 1/4 x 1 1/2 20 Pieces	37033 5/16 x 2 20 Pieces	37060 3/8 x 2 1/2 20 Pieces	37085 7/16 x 2 1/2 10 Pieces	37112 1/2 x 3 10 Pieces			
37008 1/4 x 2 20 Pieces	37035 5/16 x 2 1/2 20 Pieces	37062 3/8 x 3 20 Pieces	37087 7/16 x 3 10 Pieces	37116 1/2 x 4 10 Pieces			



CD 180 1/4 TO 1/2

CD - 546 (SAE)

Assortment includes 72 bin (99908)

Additional equipment:

- S With Stand (99910)
- B With 32 bin (99909)
- SB With both bin & stand

Label Sets Required:

- LB-922 Choice 180 SAE Cap Screws
- LB-906 SAE Hex Nuts
- LB-907 Lockwasher
- LB-903 USS Flatwasher

37621 NUT 1/4 100 Pieces	37622 NUT 5/16 100 Pieces	37623 NUT 3/8 100 Pieces	37624 NUT 7/16 50 Pieces	37625 NUT 1/2 50 Pieces			
37751 LOCK 1/4 100 Pieces	37752 LOCK 5/16 100 Pieces	37753 LOCK 3/8 100 Pieces	37754 LOCK 7/16 100 Pieces	37755 LOCK 1/2 50 Pieces			
40721 Washer 1/4 200 Pieces	40722 Washer 5/16 200 Pieces	40723 Washer 3/8 100 Pieces	40724 Washer 7/16 100 Pieces	40725 Washer 1/2 50 Pieces			
37300 1/4 x 1/2 20 Pieces	37327 5/16 x 3/4 20 Pieces	37354 3/8 x 1 20 Pieces	37377 7/16 x 3/4 10 Pieces	37404 1/2 x 1 10 Pieces			
37302 1/4 x 3/4 20 Pieces	37329 5/16 x 1 20 Pieces	37355 3/8 x 3/4 20 Pieces	37379 7/16 x 1 10 Pieces	37406 1/2 x 1 1/2 10 Pieces			
37304 1/4 x 1 20 Pieces	37330 5/16 x 1 1/4 20 Pieces	37356 3/8 x 1 1/2 20 Pieces	37381 7/16 x 1 1/2 10 Pieces	37408 1/2 x 2 10 Pieces			
37305 1/4 x 1 1/4 20 Pieces	37331 5/16 x 1 1/2 20 Pieces	37358 3/8 x 2 20 Pieces	37383 7/16 x 2 10 Pieces	37410 1/2 x 2 1/2 10 Pieces			
37306 1/4 x 1 1/2 20 Pieces	37333 5/16 x 2 20 Pieces	37360 3/8 x 2 1/2 20 Pieces	37385 7/16 x 2 1/2 10 Pieces	37412 1/2 x 3 10 Pieces			
37308 1/4 x 2 20 Pieces	37335 5/16 x 2 1/2 20 Pieces	37362 3/8 x 3 20 Pieces	37387 7/16 x 3 10 Pieces	37416 1/2 x 4 10 Pieces			



CD 180 1/4 TO 5/8

CD - 548 (USS)

Assortment includes 72 bin (99908)

Additional equipment:

- S With Stand (99910)
- B With 32 bin (99909)
- SB With both bin & stand

Label Sets Required:

- LB-921 Choice 180 USS Cap Screws
- LB-905 USS Hex Nuts
- LB-907 Lockwasher
- LB-904 SAE Flatwasher

37601 NUT 1/4 100 Pieces	37602 NUT 5/16 100 Pieces	37603 NUT 3/8 100 Pieces	37604 NUT 7/16 50 Pieces	37605 NUT 1/2 50 Pieces	37606 NUT 9/16 25 Pieces	37607 NUT 5/8 25 Pieces	
37751 LOCK 1/4 100 Pieces	37752 LOCK 5/16 100 Pieces	37753 LOCK 3/8 100 Pieces	37754 LOCK 7/16 100 Pieces	37755 LOCK 1/2 50 Pieces	37756 LOCK 9/16 50 Pieces	37757 LOCK 5/8 25 Pieces	
40701 Washer 1/4 200 Pieces	40702 Washer 5/16 200 Pieces	40703 Washer 3/8 100 Pieces	40704 Washer 7/16 100 Pieces	40705 Washer 1/2 50 Pieces	40706 Washer 9/16 25 Pieces	40707 Washer 5/8 25 Pieces	
37000 1/4 x 1/2 20 Pieces	37027 5/16 x 3/4 20 Pieces	37054 3/8 x 1 20 Pieces	37077 7/16 x 3/4 10 Pieces	37004 1/2 x 1 10 Pieces	37129 9/16 x 1 10 Pieces	37147 5/8 x 1 1/2 10 Pieces	
37002 1/4 x 3/4 20 Pieces	37029 5/16 x 1 20 Pieces	37055 3/8 x 3 1/4 20 Pieces	37079 7/16 x 1 10 Pieces	37106 1/2 x 1 1/2 10 Pieces	37131 9/16 x 1 1/2 10 Pieces	37149 5/8 x 2 5 Pieces	
37004 1/4 x 1 20 Pieces	37030 5/16 x 1 1/4 20 Pieces	37056 3/8 x 1 1/2 20 Pieces	37081 7/16 x 1 1/2 10 Pieces	37108 1/2 x 2 10 Pieces	37133 9/16 x 2 10 Pieces	37151 5/8 x 2 1/2 5 Pieces	
37005 1/4 x 1 1/4 20 Pieces	37031 5/16 x 1 1/2 20 Pieces	37058 3/8 x 2 20 Pieces	37083 7/16 x 2 10 Pieces	37110 1/2 x 2 1/2 10 Pieces	37135 9/16 x 2 1/2 5 Pieces	37153 5/8 x 3 5 Pieces	
37006 1/4 x 1 1/2 20 Pieces	37033 5/16 x 2 20 Pieces	37060 3/8 x 2 1/2 20 Pieces	37085 7/16 x 2 1/2 10 Pieces	37112 1/2 x 3 10 Pieces	37137 9/16 x 3 5 Pieces	37155 5/8 x 3 1/2 5 Pieces	
37008 1/4 x 2 20 Pieces	37035 5/16 x 2 1/2 20 Pieces	37062 3/8 x 3 20 Pieces	37087 7/16 x 3 10 Pieces	37116 1/2 x 4 10 Pieces	37139 9/16 x 3 1/2 5 Pieces	37157 5/8 x 4 5 Pieces	



CD 180 1/4 TO 5/8

CD - 550 (SAE)

Assortment includes 72 bin (99908)

Additional equipment:

- S With Stand (99910)
- B With 32 bin (99909)
- SB With both bin & stand

Label Sets Required:

- LB-922 Choice 180 SAE Cap Screws
- LB-906 SAE Hex Nuts
- LB-907 Lockwasher
- LB-903 USS Flatwasher

37621 NUT 1/4 100 Pieces	37622 NUT 5/16 100 Pieces	37623 NUT 3/8 100 Pieces	37624 NUT 7/16 50 Pieces	37625 NUT 1/2 50 Pieces	37626 NUT 9/16 25 Pieces	37627 NUT 5/8 25 Pieces	
37751 LOCK 1/4 100 Pieces	37752 LOCK 5/16 100 Pieces	37753 LOCK 3/8 100 Pieces	37754 LOCK 7/16 100 Pieces	37755 LOCK 1/2 50 Pieces	37756 LOCK 9/16 50 Pieces	37757 LOCK 5/8 25 Pieces	
40721 Washer 1/4 200 Pieces	40722 Washer 5/16 200 Pieces	40723 Washer 3/8 100 Pieces	40724 Washer 7/16 100 Pieces	40725 Washer 1/2 50 Pieces	40726 Washer 9/16 25 Pieces	40727 Washer 5/8 25 Pieces	
37300 1/4 x 1/2 20 Pieces	37327 5/16 x 3/4 20 Pieces	37354 3/8 x 1 20 Pieces	37377 7/16 x 3/4 10 Pieces	37404 1/2 x 1 10 Pieces	37429 9/16 x 1 10 Pieces	37447 5/8 x 1 1/2 10 Pieces	
37302 1/4 x 3/4 20 Pieces	37329 5/16 x 1 20 Pieces	37355 3/8 x 3 1/4 20 Pieces	37379 7/16 x 1 10 Pieces	37406 1/2 x 1 1/2 10 Pieces	37431 9/16 x 1 1/2 10 Pieces	37449 5/8 x 2 5 Pieces	
37304 1/4 x 1 20 Pieces	37330 5/16 x 1 1/4 20 Pieces	37356 3/8 x 1 1/2 20 Pieces	37381 7/16 x 1 1/2 10 Pieces	37408 1/2 x 2 10 Pieces	37433 9/16 x 2 10 Pieces	37451 5/8 x 2 1/2 5 Pieces	
37305 1/4 x 1 1/4 20 Pieces	37331 5/16 x 1 1/2 20 Pieces	37358 3/8 x 2 20 Pieces	37383 7/16 x 2 10 Pieces	37410 1/2 x 2 1/2 10 Pieces	37435 9/16 x 2 1/2 5 Pieces	37453 5/8 x 3 5 Pieces	
37306 1/4 x 1 1/2 20 Pieces	37333 5/16 x 2 20 Pieces	37360 3/8 x 2 1/2 20 Pieces	37385 7/16 x 2 1/2 10 Pieces	37412 1/2 x 3 10 Pieces	37437 9/16 x 3 5 Pieces	37455 5/8 x 3 1/2 5 Pieces	
37308 1/4 x 2 20 Pieces	37335 5/16 x 2 1/2 20 Pieces	37362 3/8 x 3 20 Pieces	37387 7/16 x 3 10 Pieces	37416 1/2 x 4 10 Pieces	37439 9/16 x 3 1/2 5 Pieces	37457 5/8 x 4 5 Pieces	



CD 180 1/4 TO 3/4

CD - 551 (USS)

Assortment includes 72 bin (99908)

Label Sets Required:

Additional equipment:

- S With Stand (99910)
- B With 32 bin (99909)
- SB With both bin & stand

- LB-921 Choice 180 USS Cap Screws
- LB-905 USS Hex Nuts
- LB-907 Lockwasher
- LB-904 SAE Flatwasher

37601 NUT 1/4 100 Pieces	37602 NUT 5/16 100 Pieces	37603 NUT 3/8 100 Pieces	37604 NUT 7/16 50 Pieces	37605 NUT 1/2 50 Pieces	37606 NUT 9/16 25 Pieces	37607 NUT 5/8 25 Pieces	37608 NUT 3/4 25 Pieces
37751 LOCK 1/4 100 Pieces	37752 LOCK 5/16 100 Pieces	37753 LOCK 3/8 100 Pieces	37754 LOCK 7/16 100 Pieces	37755 LOCK 1/2 50 Pieces	37756 LOCK 9/16 50 Pieces	37757 LOCK 5/8 25 Pieces	37758 LOCK 3/4 25 Pieces
40701 Washer 1/4 200 Pieces	40702 Washer 5/16 200 Pieces	40703 Washer 3/8 100 Pieces	40704 Washer 7/16 100 Pieces	40705 Washer 1/2 50 Pieces	40706 Washer 9/16 25 Pieces	40707 Washer 5/8 25 Pieces	40708 Washer 3/4 25 Pieces
37000 1/4 x 1/2 20 Pieces	37027 5/16 x 3/4 20 Pieces	37054 3/8 x 1 20 Pieces	37077 7/16 x 3/4 10 Pieces	37104 1/2 x 1 10 Pieces	37129 9/16 x 1 10 Pieces	37147 5/8 x 1 1/2 10 Pieces	37172 3/4 x 2 10 Pieces
37002 1/4 x 3/4 20 Pieces	37029 5/16 x 1 20 Pieces	37055 3/8 x 1 1/4 20 Pieces	37079 7/16 x 1 10 Pieces	37106 1/2 x 1 1/2 10 Pieces	37131 9/16 x 1 1/2 10 Pieces	37149 5/8 x 2 5 Pieces	37174 3/4 x 2 1/2 10 Pieces
37004 1/4 x 1 20 Pieces	37030 5/16 x 1 1/4 20 Pieces	37056 3/8 x 1 1/2 20 Pieces	37081 7/16 x 1 1/2 10 Pieces	37108 1/2 x 2 10 Pieces	37133 9/16 x 2 10 Pieces	37151 5/8 x 2 1/2 5 Pieces	37176 3/4 x 3 5 Pieces
37005 1/4 x 1 1/4 20 Pieces	37031 5/16 x 1 1/2 20 Pieces	37058 3/8 x 2 20 Pieces	37083 7/16 x 2 10 Pieces	37110 1/2 x 2 1/2 10 Pieces	37135 9/16 x 2 1/2 5 Pieces	37153 5/8 x 3 5 Pieces	37178 3/4 x 3 1/2 5 Pieces
37006 1/4 x 1 1/2 20 Pieces	37033 5/16 x 2 20 Pieces	37060 3/8 x 2 1/2 20 Pieces	37085 7/16 x 2 1/2 10 Pieces	37112 1/2 x 3 10 Pieces	37137 9/16 x 3 5 Pieces	37155 5/8 x 3 1/2 5 Pieces	37180 3/4 x 4 5 Pieces
37008 1/4 x 2 20 Pieces	37035 5/16 x 2 1/2 20 Pieces	37062 3/8 x 3 20 Pieces	37087 7/16 x 3 10 Pieces	37116 1/2 x 4 10 Pieces	37139 9/16 x 3 1/2 5 Pieces	37157 5/8 x 4 5 Pieces	37181 3/4 x 4 1/2 5 Pieces



CD 180 1/4 TO 3/4

CD - 552 (SAE)

Assortment includes 72 bin (99908)

Additional equipment:

- S With Stand (99910)
- B With 32 bin (99909)
- SB With both bin & stand

Label Sets Required:

- LB-922 Choice 180 SAE Cap Screws
- LB-906 SAE Hex Nuts
- LB-907 Lockwasher
- LB-903 USS Flatwasher

37621 NUT 1/4 100 Pieces	37622 NUT 5/16 100 Pieces	37623 NUT 3/8 100 Pieces	37624 NUT 7/16 50 Pieces	37625 NUT 1/2 50 Pieces	37626 NUT 9/16 25 Pieces	37627 NUT 5/8 25 Pieces	37628 NUT 3/4 25 Pieces
37751 LOCK 1/4 100 Pieces	37752 LOCK 5/16 100 Pieces	37753 LOCK 3/8 100 Pieces	37754 LOCK 7/16 100 Pieces	37755 LOCK 1/2 50 Pieces	37756 LOCK 9/16 50 Pieces	37757 LOCK 5/8 25 Pieces	37758 LOCK 3/4 25 Pieces
40721 Washer 1/4 200 Pieces	40722 Washer 5/16 200 Pieces	40723 Washer 3/8 100 Pieces	40724 Washer 7/16 100 Pieces	40725 Washer 1/2 50 Pieces	40726 Washer 9/16 25 Pieces	40727 Washer 5/8 25 Pieces	40728 Washer 3/4 25 Pieces
37300 1/4 x 1/2 20 Pieces	37327 5/16 x 3/4 20 Pieces	37354 3/8 x 1 20 Pieces	37377 7/16 x 3/4 10 Pieces	37404 1/2 x 1 10 Pieces	37429 9/16 x 1 10 Pieces	37447 5/8 x 1 1/2 10 Pieces	37472 3/4 x 2 10 Pieces
37302 1/4 x 3/4 20 Pieces	37329 5/16 x 1 20 Pieces	37355 3/8 x 3 1/4 20 Pieces	37379 7/16 x 1 10 Pieces	37406 1/2 x 1 1/2 10 Pieces	37431 9/16 x 1 1/2 10 Pieces	37449 5/8 x 2 5 Pieces	37474 3/4 x 2 1/2 10 Pieces
37304 1/4 x 1 20 Pieces	37330 5/16 x 1 1/4 20 Pieces	37356 3/8 x 1 1/2 20 Pieces	37381 7/16 x 1 1/2 10 Pieces	37408 1/2 x 2 10 Pieces	37433 9/16 x 2 10 Pieces	37451 5/8 x 2 1/2 5 Pieces	37476 3/4 x 3 5 Pieces
37305 1/4 x 1 1/4 20 Pieces	37331 5/16 x 1 1/2 20 Pieces	37358 3/8 x 2 20 Pieces	37383 7/16 x 2 10 Pieces	37410 1/2 x 2 1/2 10 Pieces	37435 9/16 x 2 1/2 5 Pieces	37453 5/8 x 3 5 Pieces	37478 3/4 x 3 1/2 5 Pieces
37306 1/4 x 1 1/2 20 Pieces	37333 5/16 x 2 20 Pieces	37360 3/8 x 2 1/2 20 Pieces	37385 7/16 x 2 1/2 10 Pieces	37412 1/2 x 3 10 Pieces	37437 9/16 x 3 5 Pieces	37455 5/8 x 3 1/2 5 Pieces	37480 3/4 x 4 5 Pieces
37308 1/4 x 2 20 Pieces	37335 5/16 x 2 1/2 20 Pieces	37362 3/8 x 3 20 Pieces	37387 7/16 x 3 10 Pieces	37416 1/2 x 4 10 Pieces	37439 9/16 x 3 1/2 5 Pieces	37457 5/8 x 4 5 Pieces	37481 3/4 x 4 1/2 5 Pieces

METRIC 8.8

CD - 562

Assortment includes 72 bin (99908)

Label Sets Required:

Additional equipment:

- **S With Stand (99910)**

LB-929 Metric 8.8 Cap Screws

- **B With 32 bin (99909)**

LB-936 Metric Lockwashers

- **SB With both bin & stand**

LB-934 Metric Flatwashers

LB-935 Metric Hex Nuts

36502 Hex Nuts M6 100 Pieces	36504 Hex Nuts M8 100 Pieces	36505 Hex Nuts M10 50 Pieces	36506 Hex Nuts M12 50 Pieces				
36514 Flat M6 100 Pieces	36516 Flat M8 100 Pieces	36517 Flat M10 50 Pieces	36518 Flat s M12 50 Pieces				
36525 Lock M6 100 Pieces	26527 Lock M8 100 Pieces	36528 Lock M10 50 Pieces	36529 Lock M12 50 Pieces				
36558 6 x 10 25 Pieces	36588 8 x 16 25 Pieces	36605 10 x 16 25 Pieces	36622 12 x 20 25 Pieces				
36559 6 x 12 25 Pieces	36590 8 x 20 25 Pieces	36606 10 x 20 25 Pieces	36623 12 x 25 25 Pieces				
36561 6 x 16 25 Pieces	36592 8 x 25 25 Pieces	36607 10 x 25 25 Pieces	36624 12 x 30 25 Pieces				
36563 6 x 20 25 Pieces	36593 8 x 30 25 Pieces	36608 10 x 30 25 Pieces	36625 12 x 35 25 Pieces				
35564 6 x 25 25 Pieces	36594 8 x 35 25 Pieces	36609 10 x 35 25 Pieces	36626 12 x 40 25 Pieces				
36565 6 x 30 25 Pieces	36595 8 x 40 25 Pieces	36610 10 x 40 25 Pieces	36627 12 x 50 25 Pieces				

METRIC 8.8

CD - 563

Assortment includes 72 bin (99908)

Label Sets Required:

Additional equipment:

- S With Stand (99910)
- B With 32 bin (99909)
- SB With both bin & stand

LB-929 Metric 8.8 Cap Screws

LB-936 Metric Lockwashers

LB-934 Metric Flatwashers

LB-935 Metric Hex Nuts

36501 Hex Nuts M5 100 Pieces	36502 Hex Nuts M6 100 Pieces	36503 Hex Nuts M7 100 Pieces	36504 Hex Nuts M8 100 Pieces	36505 Hex Nuts M10 50 Pieces	36506 Hex Nuts M12 50 Pieces	36507 Hex Nuts M14 25 Pieces	36508 Hex Nuts M16 25 Pieces
36513 Flat M5 100 Pieces	36514 Flat M6 100 Pieces	36515 Flat M7 100 Pieces	36516 Flat M8 100 Pieces	36517 Flat M10 50 Pieces	36518 Flat s M12 50 Pieces	36519 Flat M14 10 Pieces	36520 Flat M16 10 Pieces
36524 Lock M5 100 Pieces	36525 Lock M6 100 Pieces	36526 Lock M7 100 Pieces	36527 Lock M8 100 Pieces	36528 Lock M10 50 Pieces	36529 Lock M12 50 Pieces	36530 Lock M14 25 Pieces	36531 Lock M16 25 Pieces
36545 5 x 10 25 Pieces	36558 6 x 10 25 Pieces	36576 7 x 16 25 Pieces	36588 8 x 16 25 Pieces	36605 10 x 16 25 Pieces	36622 12 x 20 25 Pieces	36650 14 x 25 10 Pieces	36675 16 x 30 10 Pieces
36546 5 x 12 25 Pieces	36559 6 x 12 25 Pieces	36577 7 x 20 25 Pieces	36590 8 x 20 25 Pieces	36606 10 x 20 25 Pieces	36623 12 x 25 25 Pieces	36651 14 x 30 10 Pieces	36676 16 x 35 10 Pieces
36547 5 x 16 25 Pieces	36561 6 x 16 25 Pieces	36578 7 x 25 25 Pieces	36592 8 x 25 25 Pieces	36607 10 x 25 25 Pieces	36624 12 x 30 25 Pieces	36652 14 x 35 10 Pieces	36677 16 x 40 10 Pieces
36548 5 x 20 25 Pieces	36563 6 x 20 25 Pieces	36579 7 x 30 25 Pieces	36593 8 x 30 25 Pieces	36608 10 x 30 25 Pieces	36625 12 x 35 25 Pieces	36653 14 x 40 10 Pieces	36679 16 x 50 10 Pieces
36549 5 x 25 25 Pieces	36564 6 x 25 25 Pieces	36580 7 x 35 25 Pieces	36594 8 x 35 25 Pieces	36609 10 x 35 25 Pieces	36626 12 x 40 25 Pieces	36655 14 x 50 10 Pieces	36680 16 x 60 10 Pieces
36550 5 x 30 25 Pieces	36565 6 x 30 25 Pieces	36581 7 x 40 25 Pieces	36595 8 x 40 25 Pieces	36610 10 x 40 25 Pieces	36627 12 x 50 25 Pieces	36656 14 x 60 10 Pieces	36681 16 x 70 10 Pieces

METRIC 10.9

CD - 564

Assortment includes 72 bin (99908)

Label Sets Required:

Additional equipment:

- S With Stand (99910)
- B With 32 bin (99909)
- SB With both bin & stand

- LB-931 Metric 10.9 Cap Screws
- LB-932 Metric 10.0 Hex Nuts
- LB-933 Metric 10.9 Lockwashers
- LB-934 Metric Flatwashers

76010 Hex Nuts M6 100 Pieces	76012 Hex Nuts M8 100 Pieces	76013 Hex Nuts M10 50 Pieces	76014 Hex Nuts M12 50 Pieces				
76001 Flat M6 100 Pieces	76002 Flat M8 100 Pieces	76003 Flat M10 50 Pieces	76004 Flat M12 50 Pieces				
76037 Lock M6 100 Pieces	76039 Lock M8 100 Pieces	76040 Lock M10 50 Pieces	76041 Lock M12 50 Pieces				
76058 6 x 10 25 Pieces	76090 8 x 20 25 Pieces	76106 10 x 20 20 Pieces	76122 12 x 20 20 Pieces				
76059 6 x 12 25 Pieces	76092 8 x 25 25 Pieces	76107 10 x 25 20 Pieces	76123 12 x 25 20 Pieces				
76061 6 x 16 25 Pieces	76093 8 x 30 25 Pieces	76108 10 x 30 20 Pieces	76124 12 x 30 20 Pieces				
76063 6 x 20 25 Pieces	76094 8 x 35 25 Pieces	76109 10 x 35 20 Pieces	76125 12 x 35 20 Pieces				
76064 6 x 25 25 Pieces	76095 8 x 40 25 Pieces	76110 10 x 40 20 Pieces	76126 12 x 40 20 Pieces				
76065 6 x 30 25 Pieces	76096 8 x 45 25 Pieces	76111 10 x 45 20 Pieces	76127 12 x 50 10 Pieces				

METRIC 10.9

CD - 565

Assortment includes 72 bin (99908)

Label Sets Required:

Additional equipment:

- S With Stand (99910)

LB-931 Metric 10.9 Cap Screws

- B With 32 bin (99909)

LB-932 Metric 10.0 Hex Nuts

- SB With both bin & stand

LB-933 Metric 10.9 Lockwashers

LB-934 Metric Flatwashers

76010 Hex Nuts M6 100 Pieces	76012 Hex Nuts M8 100 Pieces	76013 Hex Nuts M10 50 Pieces	76014 Hex Nuts M12 50 Pieces	76015 Hex Nuts M14 25 Pieces	76016 Hex Nuts M16 25 Pieces		
76001 Flat M6 100 Pieces	76002 Flat M8 100 Pieces	76003 Flat M10 50 Pieces	76004 Flat M12 50 Pieces	76005 Flat M14 10 Pieces	76006 Flat M16 10 Pieces		
76037 Lock M6 100 Pieces	76039 Lock M8 100 Pieces	76040 Lock M10 50 Pieces	76041 Lock M12 50 Pieces	76042 Lock M14 25 Pieces	76043 Lock M16 25 Pieces		
76058 6 x 10 25 Pieces	76090 8 x 20 25 Pieces	76106 10 x 20 20 Pieces	76122 12 x 20 20 Pieces	76150 14 x 25 10 Pieces	76176 16 x 35 10 Pieces		
76059 6 x 12 25 Pieces	76092 8 x 25 25 Pieces	76107 10 x 25 20 Pieces	76123 12 x 25 20 Pieces	76151 14 x 30 10 Pieces	76177 16 x 40 5 Pieces		
76061 6 x 16 25 Pieces	76093 8 x 30 25 Pieces	76108 10 x 30 20 Pieces	76124 12 x 30 20 Pieces	76152 14 x 35 10 Pieces	76179 16 x 50 5 Pieces		
76063 6 x 20 25 Pieces	76094 8 x 35 25 Pieces	76109 10 x 35 20 Pieces	76125 12 x 35 20 Pieces	76153 14 x 40 5 Pieces	76180 16 x 60 5 Pieces		
76064 6 x 25 25 Pieces	76095 8 x 40 25 Pieces	76110 10 x 40 20 Pieces	76126 12 x 40 20 Pieces	76155 14 x 50 5 Pieces	76181 16 x 70 5 Pieces		
76065 6 x 30 25 Pieces	76096 8 x 45 25 Pieces	76111 10 x 45 20 Pieces	76127 12 x 50 10 Pieces	76156 14 x 60 5 Pieces	76183 16 x 80 5 Pieces		

METRIC 8.8 FINE THREAD

CD - 568

ASSORTMENTS INCLUDES A 40 BIN (99927)

Label Sets Required:

LB-930 Metric 8.8 Fine Cap Screws

LB-936 Metric Lockwashers

LB-934 Metric Flatwashers

36250 Hex Nut M8 100 Pieces	36527 L. Washer M8 100 Pieces	36516 Washer M8 100 Pieces	36260 1 x 20 25	36261 1 x 25 25	36262 1 x 30 25	36263 1 x 35 25	36264 1 x 40 25
36251 Hex Nut M10 50 Pieces	36528 L. Washer M10 50 Pieces	36517 Washer M10 50 Pieces	36270 1 x 25 25	36271 1 x 30 25	36272 1 x 35 25	36273 1 x 40 25	36274 1 x 45 25
36255 Hex Nut M10 50 Pieces	36528 L. Washer M10 50 Pieces	36517 Washer M10 50 Pieces	36310 1.25 x 25 25	36311 1.25 x 30 25	36312 1.25 x 35 25	36313 1.25 x 40 25	36314 1.25 x 45 25
36256 Hex Nut M12 50 Pieces	36529 L. Washer M12 50 Pieces	36518 Washer M12 50 Pieces	36325 1.25 x 25 25	36326 1.25 x 30 25	36327 1.25 x 35 25	36328 1.25 x 40 25	36329 1.25 x 45 25
36252 Hex Nut M12 50 Pieces	36529 L. Washer M12 50 Pieces	36518 Washer M12 50 Pieces	36280 1.5 x 25 25	36281 1.5 x 30 25	36282 1.5 x 35 25	36283 1.5 x 40 25	36284 1.5 x 45 25

METRIC 8.8 FINE THREAD

CD - 569

Assortment includes 72 bin (99908)

Label Sets Required:

LB-930 Metric 8.8 Fine Cap Screws

LB-936 Metric Lockwashers

LB-934 Metric Flatwashers

	36250 Hex Nuts M8 100 Pieces	36251 Hex Nuts M10 50 Pieces	36255 Hex Nuts M10 50 Pieces	36256 Hex Nuts M12 50 Pieces	36252 Hex Nuts M12 50 Pieces		
	36516 Flat M8 100 Pieces	36517 Flat M10 50 Pieces	36517 Flat M10 50 Pieces	36518 Flat M12 50 Pieces	36518 Flat M12 50 Pieces		
	36527 Lock M8 100 Pieces	36528 Lock M10 50 Pieces	36528 Lock M10 50 Pieces	36529 Lock M12 50 Pieces	36529 Lock M12 50 Pieces		
	36260 1 x 20 25 Pieces	36270 1 x 25 25 Pieces	36310 1.25 x 25 25 Pieces	36325 1.25 x 25 25 Pieces	36280 1.5 x 25 25 Pieces		
	36261 1 x 25 25 Pieces	36271 1 x 30 25 Pieces	36311 1.25 x 30 25 Pieces	36326 1.25 x 30 25 Pieces	36281 1.5 x 30 25 Pieces		
	36262 1 x 30 25 Pieces	36272 1 x 35 25 Pieces	36312 1.25 x 35 25 Pieces	36327 1.25 x 35 25 Pieces	36282 1.5 x 35 25 Pieces		
	36263 1 x 35 25 Pieces	36273 1 x 40 25 Pieces	36313 1.25 x 40 25 Pieces	36328 1.25 x 40 25 Pieces	36283 1.5 x 40 25 Pieces		
	36264 1 x 40 25 Pieces	36274 1 x 45 25 Pieces	36314 1.25 x 45 25 Pieces	36329 1.25 x 45 25 Pieces	36284 1.5 x 45 25 Pieces		
	36265 1 x 45 25 Pieces	36275 1 x 50 25 Pieces	36315 1.25 x 50 25 Pieces	36330 1.25 x 50 25 Pieces	36285 1.5 x 50 25 Pieces		

CD-570

ASSORTMENTS INCLUDES A 18 DRAW BIN
PART #99930

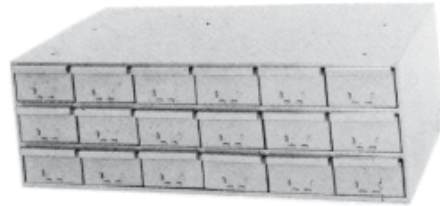
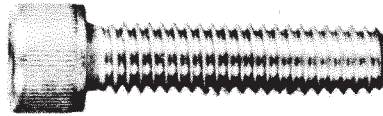

- Heat Treated Alloy Steel
- Meets ANSI/ASME B18.3-1982

Label Sets Required:

LB-948 USS Socket Head Cap Screws

#6 DIAMETER			
Lgth.	UNC (USS) TPI-32	UNF (SAE) TPI-40	Unit
1/4	28950	*	50
3/8	28951	*	50
1/2	28952	*	50
5/8	28953	*	50
3/4	28954	*	50
1	28955	*	50
#8 DIAMETER			
Lgth.	UNC (USS) TPI-32	UNF (SAE) TPI-40	Unit
1/4	28960	*	50
3/8	28961	*	50
1/2	28962	*	50
5/8	28963	*	50
3/4	28965	*	50
1	28966	*	50
1 1/4	28967	*	50
1 1/2	28968	*	50
#10 DIAMETER			
Lgth.	UNC (USS) TPI-24	UNF (SAE) TPI-32	Unit
1/2	28970	29270	50
3/4	28971	29271	50
1	28972	29272	50
1 1/4	28973	29273	25
1 1/2	28974	29274	25
1 3/4	28975	29275	25
2	28976	29276	25

1/4" DIAMETER			
Lgth.	UNC (USS) TPI-20	UNF (SAE) TPI-28	Unit
1/2	29000	*	25
3/4	29002	*	25
1	29004	*	25
1 1/4	29005	*	25
1 1/2	29006	*	20
1 3/4	29007	*	20
2	29008	*	20
2 1/4	29009	*	20
2 1/2	29010	*	20
3	29012	*	20
5/16" DIAMETER			
Lgth.	UNC (USS) TPI-18	UNF (SAE) TPI-24	Unit
1/2	29025	*	25
3/4	29027	*	25
1	29029	*	25
1 1/4	29030	*	25
1 1/2	29031	*	20
1 3/4	29032	*	20
2	29033	*	20
2 1/4	29034	*	20
2 1/2	29035	*	10
3	29037	*	10
3/8" DIAMETER			
Lgth.	UNC (USS) TPI-16	UNF (SAE) TPI-24	Unit
1/2	29050	*	20
3/4	29052	*	20
1	29054	*	20
1 1/4	29055	*	20
1 1/2	29056	*	10
1 3/4	29057	*	10
2	29058	*	10
2 1/2	29060	*	10

SOCKET CAP SCREW

CD - 571

Assortment includes 72 bin (99908)

Additional equipment:

- S With Stand (99910)
- B With 32 bin (99909)
- SB With both bin & stand

Label Sets Required:

LB-948 USS Socket Head Cap Screws

28950 #6-32x1/4 50 Pieces	28960 #8 x 1/4 50 Pieces	28970 #10-24x1/2 50 Pieces	29270 #10-32 x1/2 50 Pieces	29000 1/4 x 1/2 25Pieces	29025 5/16 x 1/2 25Pieces	29050 3/8 x 1/2 20 Pieces	
28951 #6 x3/8 50 Pieces	28961 #8 x 3/8 50 Pieces	28971 #10-24x3/4 50 Pieces	29271 #10-32x3/4 50 Pieces	29002 1/4 x 3/4 25 Pieces	29027 5/16 x 3/4 25 Pieces	29052 3/8 x 3/4 20 Pieces	
28952 #6 x 1/2 50 Pieces	28962 #8 x 1/2 50 Pieces	28972 #10-24 x1 50 Pieces	29272 #10-32 x1 50 Pieces	29004 1/4 x 1 25 Pieces	29029 5/16 x 1 25 Pieces	29054 3/8 x 1 20 Pieces	
28953 #6 x5/8 50 Pieces	28963 #8 x 5/8 50 Pieces	28973 #10 x11/4 25 Pieces	29273 #10 x11/4 25 Pieces	29005 1/4 x 1 1/4 25 Pieces	29030 5/16 x 1 1/4 25 Pieces	29055 3/8 x1 1/4 20 Pieces	
28954 #6 x 3/4 50 Pieces	28965 #8 x3/4 50 Pieces	28974 #10 x 11/2 25 Pieces	29274 #10 x 11/2 25 Pieces	29006 1/4 x 1 1/2 20 Pieces	29031 5/16 x 1 1/2 20 Pieces	29056 3/8 x 1 1/2 10 Pieces	
28955 #6 x 1 50 Pieces	28966 #8 x 1 50 Pieces	28975 #10- x3/4 25Pieces	29275 #10- x3/4 25Pieces	29007 1/4 x 1 3/4 20 Pieces	29032 5/16 x 1 3/4 20 Pieces	29057 3/8 x 1 3/4 10 Pieces	
	28967 #8 x 1-1/4 50 Pieces	28976 #10 x2 25 Pieces	29276 #10 x2 25 Pieces	29008 1/4 x 2 20 Pieces	29033 5/16 x 2 20 Pieces	29058 3/8 x 2 10 Pieces	
	28968 #8 x 1-1/2 50 Pieces			29009 1/4 x 2 1/4 20 Pieces	29034 5/16x 2 1/4 20 Pieces	29060 3/8 x 2 1/2 10 Pieces	
				29010 1/4 x 2 1/2 20 Pieces	29035 5/16 x 2 1/2 10 Pieces		

USS GRADE 5

1/4 TO 1/2

CD - 580

(C40350)



ASSORTMENT INCLUDES A 40 BIN (99927)

Label Sets Required:

LB-901 GR5 USS Cap Screws

LB-910 USS Hex Nuts

LB-907 Lockwasher

LB-903 USS Flatwasher

31651 Nut 1/4 50 Pieces	31751 L. Washer 1/4 100 Pieces	31721 Washer 1/4 100 Pieces	31000 1/4 x 1/2 25 Pieces	31002 1/4 x 3/4 25 Pieces	31003 1/4 x 1 25 Pieces	31007 1/4 x 2 25 Pieces	31012 1/4 x 3 25 Pieces
31652 Nut 5/16 50 Pieces	31752 L. Washer 5/16 100 Pieces	31722 Washer 5/16 100 Pieces	31027 5/16 x 3/4 25 Pieces	31029 5/16 x 1 25 Pieces	31031 5/16 x 1 1/2 25 Pieces	31033 5/16 x 2 25 Pieces	31037 5/16 x 3 25 Pieces
31653 Nut 3/8 50 Pieces	31753 L. Washer 3/8 100 Pieces	31723 Washer 3/8 100 Pieces	31052 3/8 x 3/4 25 Pieces	31054 3/8 x 1 25 Pieces	31056 3/8 x 1 1/2 25 Pieces	31058 3/8 x 2 25 Pieces	31062 3/8 x 3 25 Pieces
31654 Nut 7/16 50 Pieces	31754 L. Washer 7/16 100 Pieces	31724 Washer 7/16 100 Pieces	31079 7/16 x 1 25 Pieces	31081 7/16 x 1 1/2 25 Pieces	31083 7/16 x 2 25 Pieces	31085 7/16 x 2 1/2 25 Pieces	31087 7/16 x 3 25 Pieces
31655 Nut 1/2 50 Pieces	31755 L. Washer 1/2 100 Pieces	31725 Washer 1/2 100 Pieces	31104 1/2 x 1 25 Pieces	31106 1/2 x 1 1/2 25 Pieces	31108 1/2 x 2 25 Pieces	31110 1/2 x 2 1/2 25 Pieces	31112 1/2 x 3 10 Pieces

SAE GRADE 5

1/4 TO 1/2



CD - 581
(C40360)

ASSORTMENTS INCLUDES A 40 BIN (99927)

Label Sets Required:

LB-902 GR5 SAE Cap Screws

LB-911 SAE Hex Nuts

LB-907 Lockwasher

LB-904 SAE Flatwasher

31671 Nut 1/4 50 Pieces	31751 L. Washer 1/4 100 Pieces	31701 Washer 1/4 100 Pieces	31301 1/4 x 1/2 25 Pieces	31302 1/4 x 3/4 25 Pieces	31303 1/4 x 1 25 Pieces	31307 1/4 x 2 25 Pieces	31312 1/4 x 3 25 Pieces
31672 Nut 5/16 50 Pieces	31752 L. Washer 5/16 100 Pieces	31702 Washer 5/16 100 Pieces	31327 5/16 x 3/4 25 Pieces	31329 5/16 x 1 25 Pieces	31331 5/16 x 1 1/2 25 Pieces	31333 5/16 x 2 25 Pieces	31337 5/16 x 3 25 Pieces
31673 Nut 3/8 50 Pieces	31753 L. Washer 3/8 100 Pieces	31703 Washer 3/8 100 Pieces	31352 3/8 x 3/4 25 Pieces	31354 3/8 x 1 25 Pieces	31356 3/8 x 1 1/2 25 Pieces	31358 3/8 x 2 25 Pieces	31362 3/8 x 3 25 Pieces
31674 Nut 7/16 50 Pieces	31754 L. Washer 7/16 100 Pieces	31704 Washer 7/16 100 Pieces	31379 7/16 x 1 25 Pieces	31381 7/16 x 1 1/2 25 Pieces	31383 7/16 x 2 25 Pieces	31385 7/16 x 2 1/2 25 Pieces	31387 7/16 x 3 25 Pieces
31675 Nut 1/2 50 Pieces	31755 L. Washer 1/2 100 Pieces	31705 Washer 1/2 100 Pieces	31404 1/2 x 1 25 Pieces	31406 1/2 x 1 1/2 25 Pieces	31408 1/2 x 2 25 Pieces	31410 1/2 x 2 1/2 25 Pieces	31412 1/2 x 3 10 Pieces

USS GRADE 8

1/4 TO 1/2

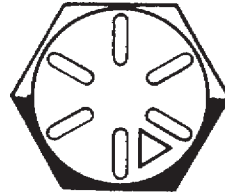

CD - 582
(C40380)

ASSORTMENT INCLUDES A 40 BIN (99927)

Label Sets Required:

- LB-912 GR8 USS Cap Screws
- LB-905 USS Hex Nuts
- LB-907 Lockwasher
- LB-903 USS Flatwasher

40601 Nut 1/4 50 Pieces	40751 L. Washer 1/4 100 Pieces	40721 Washer 1/4 100 Pieces	40002 1/4 x 3/4 25 Pieces	40004 1/4 x 1 25 Pieces	40006 1/4 x 1 1/2 25 Pieces	40008 1/4 x 2 25 Pieces	40012 1/4 x 3 25 Pieces
40602 Nut 5/16 50 Pieces	40752 L. Washer 5/16 100 Pieces	40722 Washer 5/16 100 Pieces	40027 5/16 x 3/4 25 Pieces	40029 5/16 x 1 25 Pieces	40031 5/16 x 1 1/2 25 Pieces	40033 5/16 x 2 25 Pieces	40037 5/16 x 3 25 Pieces
40603 Nut 3/8 50 Pieces	40753 L. Washer 3/8 100 Pieces	40723 Washer 3/8 100 Pieces	40052 3/8 x 3/4 25 Pieces	40054 3/8 x 1 25 Pieces	40056 3/8 x 1 1/2 25 Pieces	40058 3/8 x 2 25 Pieces	40062 3/8 x 3 25 Pieces
40604 Nut 7/16 50 Pieces	40754 L. Washer 7/16 100 Pieces	40724 Washer 7/16 100 Pieces	40079 7/16 x 1 25 Pieces	40081 7/16 x 1 1/2 25 Pieces	40083 7/16 x 2 25 Pieces	40085 7/16 x 2 1/2 25 Pieces	40087 7/16 x 3 25 Pieces
40605 Nut 1/2 50 Pieces	40755 L. Washer 1/2 100 Pieces	40725 Washer 1/2 100 Pieces	40104 1/2 x 1 25 Pieces	40106 1/2 x 1 1/2 25 Pieces	40108 1/2 x 2 25 Pieces	40110 1/2 x 2 1/2 25 Pieces	40112 1/2 x 3 10 Pieces

SAE GRADE 8

1/4 TO 1/2



CD - 583
(C40390)

ASSORTMENT INCLUDES A 40 BIN (99927)

Label Sets Required:

- LB-913 GR8 SAE Cap Screws
- LB-906 SAE Hex Nuts
- LB-907 Lockwasher
- LB-904 SAE Flatwasher















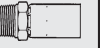















40621 Nut 1/4 50 Pieces	40751 L. Washer 1/4 100 Pieces	40701 Washer 1/4 100 Pieces	40302 1/4 x 3/4 25 Pieces	40304 1/4 x 1 25 Pieces	40306 1/4 x 1 1/2 25 Pieces	40308 1/4 x 2 25 Pieces	40312 1/4 x 3 25 Pieces
40622 Nut 5/16 50 Pieces	40752 L. Washer 5/16 100 Pieces	40702 Washer 5/16 100 Pieces	40327 5/16 x 3/4 25 Pieces	40329 5/16 x 1 25 Pieces	40331 5/16 x 1 1/2 25 Pieces	40333 5/16 x 2 25 Pieces	40337 5/16 x 3 25 Pieces
40623 Nut 3/8 50 Pieces	40753 L. Washer 3/8 100 Pieces	40703 Washer 3/8 100 Pieces	40352 3/8 x 3/4 25 Pieces	40354 3/8 x 1 25 Pieces	40356 3/8 x 1 1/2 25 Pieces	40358 3/8 x 2 25 Pieces	40362 3/8 x 3 25 Pieces
40624 Nut 7/16 50 Pieces	40754 L. Washer 7/16 100 Pieces	40704 Washer 7/16 100 Pieces	40379 7/16 x 1 25 Pieces	40381 7/16 x 1 1/2 25 Pieces	40383 7/16 x 2 25 Pieces	40385 7/16 x 2 1/2 25 Pieces	40387 7/16 x 3 25 Pieces
40625 Nut 1/2 50 Pieces	40755 L. Washer 1/2 100 Pieces	40705 Washer 1/2 100 Pieces	40404 1/2 x 1 25 Pieces	40406 1/2 x 1 1/2 25 Pieces	40408 1/2 x 2 25 Pieces	40410 1/2 x 2 1/2 25 Pieces	40412 1/2 x 3 10 Pieces



COLL-O-CRIMP STEEL ENDS

STARTER ASSORTMENT

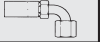
CD - 600

Label Sets Required: LB-953 Coll U Series

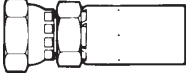
10203 (4) 	10204 (4) 	10205 (4) 	10206 (4) 	10207 (4) 	10208 (4) 	10209 (4) 	10210 (2) 
10214 (4) 	10215 (4) 	10216 (4) 	10217 (4) 	10218 (4) 	10219 (4) 	10220 (4) 	10221 (2) 
10225 (4) 	10226 (4) 	10227 (4) 	10228 (4) 	10229 (4) 	10230 (4) 	10231 (4) 	10232 (4) 
10233 (2) 	10234 (2) 	10235 (2) 	10239 (4) 	10240 (4) 	10241 (4) 		

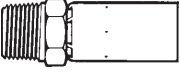
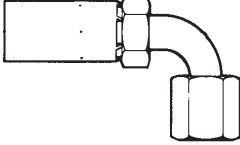
	CHOICE #	PIPE SIZE	HOSE SIZE	UNIT		CHOICE #	TUBE SIZE	HOSE SIZE	UNIT
Female Swivel 	10225	1/4	1/4	4	SAE 37° (JIC) Male Rigid 	10214	1/4	1/4	4
	10226	5/16	1/4	4		10215	5/16	1/4	4
	10227	3/8	1/4	4		10216	3/8	1/4	4
	10228	3/8	3/8	4		10217	3/8	3/8	4
	10229	3/8	3/8	4		10218	1/2	3/8	4
	10230	1/2	3/8	4		10219	1/2	1/2	4
	10231	1/2	1/2	4		10220	5/8	1/2	4
	10232	5/8	1/2	4		10221	3/4	3/4	2
	10233	3/4	3/4	2					
	10234	3/4	3/4	2					
10235	7/8	3/4	2						
Male Pipe Rigid 	10203	1/8	1/4	4	Female Swivel 90° Tube Elbow 	10239	1/4	1/4	4
	10204	1/4	1/4	4		10240	3/8	3/8	4
	10205	1/4	3/8	4		10241	1/2	1/2	4
	10206	3/8	3/8	4					
	10207	1/2	3/8	4					
	10208	3/8	1/2	4					
	10209	1/2	1/2	4					
	10210	3/4	3/4	2					

High Pressure Hydraulic Hose	1/4	25 ft.	H425-4
	3/8	25 ft.	H425-6
	1/2	25 ft.	H425-8
	3/4	25 ft.	H425-12

Assortment includes one 32 hole bin part# 99909.



















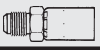



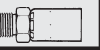

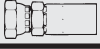















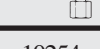



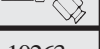













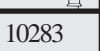

COLL-O-CRIMP STEEL ENDS

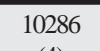
MASTER ASSORTMENT

CD - 601

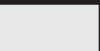
1 of 2 Pages

Label Sets Required: LB-953 Coll U Series





10203 (4) 	10204 (4) 	10205 (4) 	10206 (4) 	10207 (4) 	10208 (4) 	10209 (4) 	10209-3 (4) 
10210 (2) 	10214 (4) 	10215 (4) 	10216 (4) 	10217 (4) 	10218 (4) 	10219 (4) 	10220 (4) 
10221 (2) 	10225 (4) 	10226 (4) 	10227 (4) 	10228 (4) 	10229 (4) 	10230 (4) 	10231 (4) 
10232 (4) 	10232-1 (4) 	10232-2 (4) 	10232-3 (4) 	10233 (2) 	10234 (2) 	10235 (2) 	10239 (4) 
10240 (4) 	10241 (4) 	10242 (2) 	10245 (4) 	10246 (4) 	10247 (4) 	10248 (2) 	10251 (4) 
10253 (4) 	10254 (4) 	10256 (2) 	10260 (4) 	10261 (4) 	10262 (4) 	10263 (4) 	10265 (4) 
10266 (4) 	10267 (4) 	10268 (4) 	10270 (4) 	10271 (4) 	10272 (4) 	10273 (4) 	10275 (4) 
10276 (4) 	10277 (4) 	10278 (2) 	10280 (4) 	10281 (4) 	10282 (4) 	10283 (4) 	10284 (4) 
10285 (4) 	10286 (4) 	10287 (2) 					

COLL-O-CRIMP STEEL ENDS

MASTER ASSORTMENT

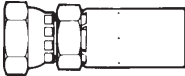
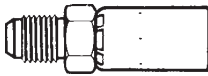
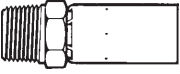
CD - 601

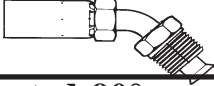
2 of 2 pages

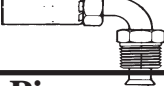
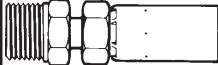
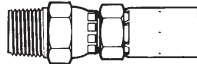
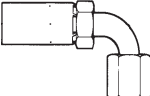
	CHOICE #	PIPE SIZE	HOSE SIZE	UNIT		CHOICE #	TUBE SIZE	HOSE SIZE	UNIT
Female Swivel 	10225	1/4	1/4	4	SAE 37° (JIC) Male Rigid 	10214	1/4	1/4	4
	10226	5/16	1/4	4		10215	5/16	1/4	4
	10227	3/8	1/4	4		10216	3/8	1/4	4
	10228	3/8	3/8	4		10217	3/8	3/8	4
	10229	3/8	3/8	4		10218	1/2	3/8	4
	10230	1/2	3/8	4		10219	1/2	1/2	4
	10231	1/2	1/2	4		10220	5/8	1/2	4
	10232	5/8	1/2	4		10221	3/4	3/4	2
	10233	3/4	3/4	2					
	10234	3/4	3/4	2					
	10235	7/8	3/4	2					
Male Pipe Rigid 	10203	1/8	1/4	4	Male Straight Thd. O-Ring, Rigid 	10280	1/4	1/4	4
	10204	1/4	1/4	4		10281	5/16	1/4	4
	10205	1/4	3/8	4		10282	3/8	1/4	4
	10206	3/8	3/8	4		10283	3/8	3/8	4
	10207	1/2	3/8	4		10284	1/2	3/8	4
	10208	3/8	1/2	4		10285	1/2	1/2	4
	10209	1/2	1/2	4		10286	5/8	1/2	4
	10210	3/4	3/4	2		10287	3/4	3/4	2
Female Swivel 45° Elbow 	10245	1/4	1/4	4	Inverted 45° Male Swivel 	10265	1/4	1/4	4
	10246	3/8	3/8	4		10266	3/8	3/8	4
	10247	1/2	1/2	4		10267	1/2	1/2	4
	10248	3/4	3/4	2		10268	3/4	3/4	2
Flareless Tube Rigid 	10251	1/4	1/4	4	Inverted 90° Male Swivel 	10270	1/4	1/4	4
	10253	3/8	3/8	4		10271	3/8	3/8	4
	10254	1/2	1/2	4		10272	1/2	1/2	4
	10256	3/4	3/4	2		10273	3/4	3/4	2
Inverted Male Swivel Straight 	10260	1/4	1/4	4	Male Pipe Swivel 	10275	1/4	1/4	4
	10261	3/8	3/8	4		10276	3/8	3/8	4
	10262	1/2	1/2	4		10277	1/2	1/2	4
	10263	3/4	3/4	2		10278	3/4	3/4	2
High Pressure Hydraulic Hose	Type	ID	Roll		Female Swivel 90° Tube Elbow 	10239	1/4	1/4	4
	H425-4	1/4	25 ft.			10240	3/8	3/8	4
	H425-6	3/8	25 ft.			10241	1/2	1/2	4
	H425-8	1/2	25 ft.						
H425-12	3/4	25 ft.							

Assortment includes one 72 hole bin part #99908.

HYDRAULIC FITTINGS

STEEL FITTING PIPE THREAD

MASTER ASSORTMENT

CD-610

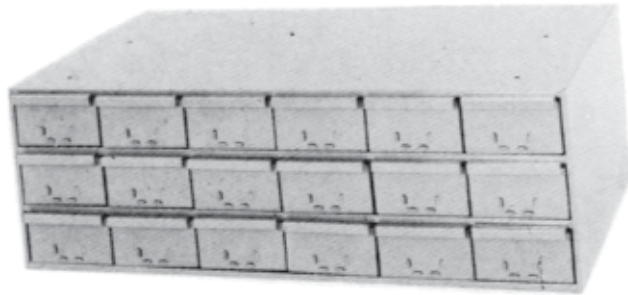

Assortment includes all the items listed below in a 18 draw 99930 bin.

Label Sets Required: LB-946 Steel Hydraulic Pipe Fittings

DESCRIPTION	CHOICE PART #	PIPE Thd.	UNIT	DESCRIPTION	CHOICE PART #	PIPE Thd.	UNIT	
HEX PLUG	95129	1/4	2	90° STREET ELBOW	95154	1/4	2	
	95130	3/8	2		95155	3/8	2	
	95131	1/2	2		95156	1/2	1	
	95132	3/4	2		95157	3/4	1	
HEX NIPPLE	95102	1/4 x 1/4	2	45° STREET ELBOW	95148	1/4	2	
	95103	3/8 x 1/4	2		95149	3/8	2	
	95105	3/8 x 3/8	2		95150	1/2	1	
	95106	1/2 x 1/4	2		95151	3/4	1	
	95107	1/2 x 3/8	2		TEE	95179	1/4	1
	95108	1/2 x 1/2	2	95180		3/8	1	
	95109	3/4 x 1/2	2	95181		1/2	1	
	95110	3/4 x 3/4	2	95182		3/4	1	
	COUPLING	95142	1/4	2				
		95143	3/8	2				
95144		1/2	2					
95145		3/4	1					
BUSHING		95115	3/8 x 1/4	2				
	95117	1/2 x 1/4	2					
	95118	1/2 x 3/8	2					
	95120	3/4 x 3/8	2					
	95121	3/4 x 1/2	2					
	95124	1 x 3/4	1					
90° ELBOW	95161	1/4	2					
	95162	3/8	2					
	95163	1/2	1					
	95164	3/4	1					

HYDRAULIC FITTINGS

JIC 37° STEEL FITTING MASTER ASSORTMENT CD-611

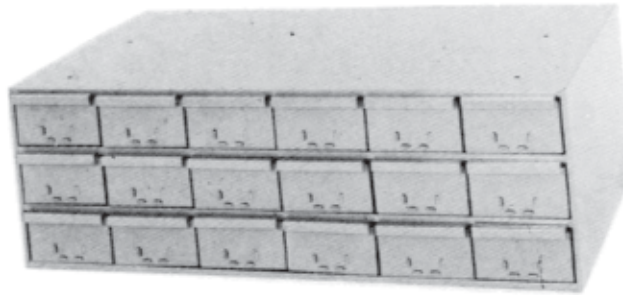

Assortment includes all the items listed below in a 18 draw 99930 bin.

Label Sets Required: LB-947 Steel Hydraulic Pipe Fittings

DESCRIPTION	CHOICE PART #	PIPE Thd.	UNIT	DESCRIPTION	CHOICE PART #	PIPE Thd.	UNIT
2 PIECE NUT	96100	1/4	2	SMALL HEX UNION	96164	1/4	2
	96101	5/16	2		96165	5/16	2
	96102	3/8	2		96166	3/8	2
	96103	1/2	2		96167	1/2	2
			96169		3/4	1	
JIC CAP	96107	1/4	2	90° MALE ELBOW	96201	1/4 x 1/4	2
	96108	5/16	2		96203	5/16 x 1/4	2
	96109	3/8	2		96205	3/8 x 1/4	2
	96110	1/2	2		96206	3/8 x 3/8	1
	96112	3/4	1		96207	3/8 x 1/2	1
JIC PLUG	96151	1/4	2		96209	1/2 x 3/8	1
	96152	5/16	2		96210	1/2 x 1/2	1
	96153	3/8	2	96211	1/2 x 3/4	1	
	96154	1/2	2	96215	3/4 x 1/2	1	
	96156	3/4	1	96216	3/4 x 3/4	1	
MALE CONNECTOR	96121	1/4 x 1/4	2	45° MALE ELBOW	96178	1/4 x 1/4	2
	96122	1/4 x 3/8	2		96180	5/16 x 1/4	2
	96125	5/16 x 1/4	2		96182	3/8 x 1/4	1
	96126	5/16 x 3/8	2		96183	3/8 x 3/8	1
	96128	3/8 x 1/4	2		96184	3/8 1/2	1
	96129	3/8 x 3/8	2		96186	1/2 x 3/8	1
	96130	3/8 x 1/2	2		96187	1/2 x 1/2	1
	96132	1/2 x 3/8	2		96190	3/4 1/2	1
	96133	1/2 x 1/2	2		96191	3/4 x 3/4	1
	96134	1/2 x 3/4	1				
	96138	3/4 x 1/2	1				
	96139	3/4 x 3/4	1				
	96140	3/4 x 1	1				

BRASS FITTING PIPE THREAD MASTER ASSORTMENT CD-620

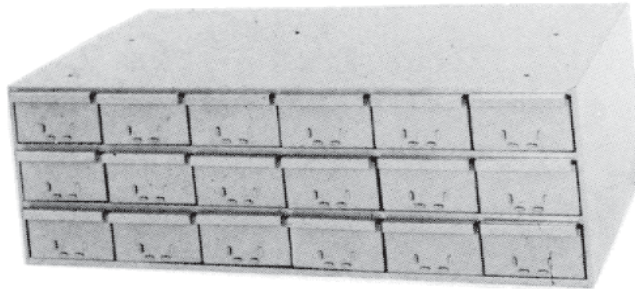

Assortment includes all the items listed below in a 18 draw 99930 bin.

Label Sets Required: LB-937 Brass Pipe

DESCRIPTION	CHOICE PART #	PIPE Thd.	UNIT
HEX PLUG	90220	1/8	4
	90221	1/4	4
	90222	3/8	4
	90223	1/2	3
HEX NIPPLE	90265	1/8	4
	90266	1/4	4
	90268	3/8	4
	90271	1/2	3
COUPLING	90252	1/8	4
	90253	1/4	4
	90254	3/8	4
	90255	1/2	3
90° STREET ELBOW	90335	1/8	4
	90336	1/4	4
	90337	3/8	3
	90338	1/2	3
BUSHING	90240	1/8 x 1/4	4
	90241	1/8 x 3/8	4
	90242	1/4 x 3/8	4
	90245	13/8 x 1/2	3
45° STREET ELBOW	90325	1/8	3
	90326	1/4	3
	90327	3/8	3
	90328	1/2	2
90° ELBOW	90345	1/8	3
	90346	1/4	3
	90347	3/8	3
	90348	1/2	2

DESCRIPTION	CHOICE PART #	PIPE Thd.	UNIT
TEE	90365	1/8	3
	90366	1/4	3
	90367	3/8	3
	90368	1/2	2
REDUCING BUSHING	90257	1/4 x 1/8	3
	90260	3/8 x 1/8	3
	90258	3/8 x 1/4	2
	90259	1/2 x 3/8	2
LONG NIPPLE	90290	1/8 x 1 1/2	2
	90296	1/4 x 2	2
	90297	3/8 x 2	2
	90298	1/2 x 2	2
	90291	1/4 x 1 1/2	2
	90295	1/8 x 2	2
	90300	1/8 x 2 1/2	2
	90301	1/4 x 2 1/2	2
	90302	3/8 x 2 1/2	2
90303	1/2 x 2 1/2	2	
ADAPTORS	90232	1/4 x 1/8	3
	90234	3/8 x 1/4	3
	90235	1/2 x 3/8	3
	90230	1/8 x 1/8	3
	90231	1/4 x 1/4	3
	90233	3/8 x 3/8	2
PIPE CROSS	90385	1/8	2
	90386	1/4	2
	90387	3/8	1
	90388	1/2	1
UNION	90250	1/8	1
	90251	1/4	1

BRASS FITTING 45° SAE MASTER ASSORTMENT CD-621

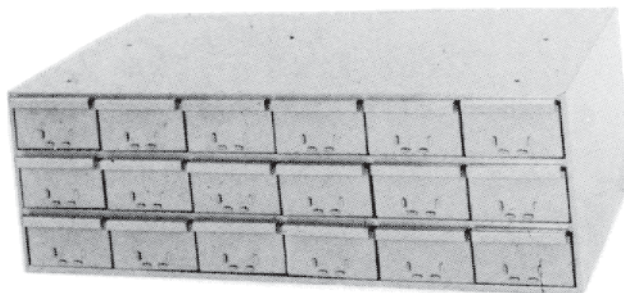

Assortment includes all the items listed below in a 18 draw 99930 bin.

Label Sets Required: LB-938 Brass Pipe

DESCRIPTION	CHOICE PART #	PIPE Thd.	UNIT	DESCRIPTION	CHOICE PART #	PIPE Thd.	UNIT
SAE NUT	90408	3/16	5	SAE 45° ELBOW	90525	1/4 x 1/8	2
	90409	1/4	5		90526	5/16 x 18	2
	90410	5/16	5		90527	3/8 x 1/4	2
	90412	3/8	4		90528	1/2 x 3/8	2
	90414	1/2	4	SAE UNION ELBOW	90530	1/4	3
SAE UNION	90422	3/16	5		90531	5/16	3
	90423	1/4	5		90532	3/8	3
	90424	5/16	5		90533	1/2	3
	90425	3/8	4	SAE UNION TEE	90430	3/16	3
	90426	1/2	4		90431	1/4	3
SAE MALE	90466	3/16 x 1/8	4		90432	5/16	3
	90467	1/4 x 1/8	4		90433	3/8	2
	90469	5/16 x 1/8	4	90434	1/2	2	
	90470	5/16 x 1/4	4	SAE FEMALE CONNECTOR	90450	3/16 x 1/8	3
	90468	1/4 x 1/4	4		90451	1/4 x 1/8	3
	90472	3/8 x 1/8	3		90452	1/4 x 1/4	3
	90471	3/8 x 1/4	3		90453	5/16 x 1/8	3
	90473	3/8 x 3/8	3		90454	5/16 x 1/4	3
	90477	1/2 x 1/4	3		90455	3/8 x 1/4	3
	90476	1/2 x 3/8	3		90459	1/2 x 3/8	3
	90° SAE ELBOW	90486	3/16 x 1/8		3	90456	3/8 x 1/8
90487		1/4 x 1/8	3				
90490		5/16 x 1/8	3				
90491		5/16 x 1/4	3				
90488		1/4 x 1/4	3				
90493		3/8 x 1/8	3				
90492		3/8 x 1/4	3				
90494		3/8 x 3/8	3				
90498		1/2 x 1/4	3				
90497		1/2 x 3/8	3				



MAINTENANCE ASST.

CD - 700

Assortment includes:

72 bin (99908)

40 bin (99927)

****Stand is extra****

Label Sets Required: LB-963 Maintenance Asst.

15002 100 Pieces	15004 100 Pieces	15006 100 Pieces	15009 25 Pieces	15010 25 Pieces	15011 25 Pieces	15012 25 Pieces	
15020 100 Pieces	15022 100 Pieces	15024 100 Pieces	15150 25 Pieces	15151 25 Pieces	15152 25 Pieces	15153 25 Pieces	15154 25 Pieces
15155 25 Pieces	15156 25 Pieces	15157 10 Pieces	15158 10 Pieces	15180 25 Pieces	15181 25 Pieces	15185 25 Pieces	15186 25 Pieces
15188 25 Pieces	15189 25 Pieces	15190 25 Pieces	15191 25 Pieces	15192 25 Pieces	15193 25 Pieces	15194 25 Pieces	15195 10 Pieces
15196 10 Pieces	15300 25 Pieces	15302 25 Pieces	15307 25 Pieces	15310 25 Pieces	15312 10 Pieces	15313 10 Pieces	15315 5 Pieces
15316 5 Pieces	15318 5 Pieces	15320 5 Pieces	15321 5 Pieces	15324 4 Pieces	15326 4 Pieces		
15350 25 Pieces	15351 10 Pieces	15352 10 Pieces	15353 5 Pieces	15354 5 Pieces	35210 10 Pieces	35211 10 Pieces	35212 10 Pieces
35213 10 Pieces	35214 10 Pieces	35215 10 Pieces	35216 5 Pieces	35217 5 Pieces	35218 5 Pieces	35219 5 Pieces	35222 25 Pieces
35224 25 Pieces	35226 25 Pieces	35228 25 Pieces	35230 25 Pieces	35242 25 Pieces	35244 25 Pieces	35246 25 Pieces	35248 25 Pieces
35250 25 Pieces	35255 25 Pieces	35264 25 Pieces	35266 10 Pieces	35268 10 Pieces	35270 10 Pieces	35272 10 Pieces	35306 10 Pieces
35308 10 Pieces	35310 10 Pieces	35311 5 Pieces	35312 5 Pieces	35328 5 Pieces	35330 5 Pieces	35332 5 Pieces	35334 5 Pieces
35022 25 Pieces	35024 25 Pieces	35026 25 Pieces	35028 25 Pieces	35044 25 Pieces	35046 25 Pieces	35048 25 Pieces	35050 25 Pieces
35064 25 Pieces	35066 25 Pieces	35068 10 Pieces	35070 10 Pieces	35104 10 Pieces	35106 10 Pieces	35108 10 Pieces	35110 10 Pieces
35111 10 Pieces	35112 5 Pieces						

LAG SCREW ASST.

CD - 701

Assortment includes:

72 bin (99908)

****Stand is extra****

Label Sets Required: LB-949 Lag Bolts

35210 25 Pieces	35212 25 Pieces	35214 25 Pieces	35216 10 Pieces	35218 10 Pieces			
35211 25 Pieces	35213 25 Pieces	35215 25 Pieces	35217 10 Pieces	35219 10 Pieces			
35222 50 Pieces	35243 50 Pieces	35262 50 Pieces	35304 25 Pieces	35328 10 Pieces			
35224 50 Pieces	35244 50 Pieces	35264 50 Pieces	35306 25 Pieces	35330 10 Pieces			
35226 50 Pieces	35246 50 Pieces	35266 50 Pieces	35308 25 Pieces	35332 10 Pieces			
35228 50 Pieces	35248 50 Pieces	35268 25 Pieces	35310 25 Pieces	35334 10 Pieces			
35230 50 Pieces	35250 50 Pieces	35270 25 Pieces	35311 10 Pieces				
35231 50 Pieces	35251 25 Pieces	35271 25 Pieces	35312 10 Pieces				
35232 50 Pieces	35252 25 Pieces	35272 25 Pieces	35313 10 Pieces				

CARRIAGE BOLT ASST.

CD -702

**Assortment includes:
72 bin (99908)
Stand is extra**

Label Sets Required: LB-959 Carriage Bolts

35022 50 Pieces	35042 50 Pieces	35062 50 Pieces	35104 25 Pieces	35124 10 Pieces	38400 50 Pieces	38421 50 Pieces	
35023 50 Pieces	35043 50 Pieces	35064 50 Pieces	35106 25 Pieces	35128 10 Pieces	38402 50 Pieces	38422 50 Pieces	
35024 50 Pieces	35044 50 Pieces	35066 50 Pieces	35108 25 Pieces	35130 10 Pieces	38403 25 Pieces	38423 50 Pieces	
35026 50 Pieces	35046 50 Pieces	35068 25 Pieces	35110 25 Pieces	35132 10 Pieces	38404 25 Pieces	38424 25 Pieces	
35028 50 Pieces	35048 50 Pieces	35070 25 Pieces	35111 25 Pieces	35134 10 Pieces	38405 25 Pieces		
35030 50 Pieces	35050 50 Pieces	35071 25 Pieces	35112 10 Pieces				
35031 50 Pieces	35051 25 Pieces	35072 25 Pieces	35113 10 Pieces				
35032 50 Pieces	35052 25 Pieces	35073 25 Pieces	35114 10 Pieces				
35033 50 Pieces	35053 25 Pieces	35074 25 Pieces					

SOCKET CAP SCREW

CD - 703

Assortment includes:
72 bin (99908)
****Stand is extra****

Label Sets Required:
 LB-925 High Lockwashers
 LB-951 Socket Cap Screw

37771 1/4 100 Pieces	37772 5/16 100 Pieces	37773 3/8 100 Pieces	37774 7/16 100 Pieces	37775 1/2 50 Pieces			
29000 1/4 x 1/2 20 Pieces	29025 5/16 x 1/2 20 Pieces	29050 3/8 x 1/2 20 Pieces	29077 7/16 x 3/4 10 Pieces	29103 1/2 x 3/4 10 Pieces			
29002 1/4 x 3/4 20 Pieces	29027 5/16 x 3/4 20 Pieces	29052 3/8 x 3/4 20 Pieces	29079 7/16 x 1 10 Pieces	29104 1/2 x 1 10 Pieces			
29004 1/4 x 1 20 Pieces	29029 5/16 x 1 20 Pieces	29054 3/8 x 1 20 Pieces	29080 7/16 x 1 1/4 10 Pieces	29106 1/2 x 1 1/2 10 Pieces			
29005 1/4 x 1 1/4 20 Pieces	29030 5/16 x 1 1/4 20 Pieces	29055 3/8 x 1 1/4 20 Pieces	29081 7/16 x 1 1/2 10 Pieces	29108 1/2 x 2 10 Pieces			
29006 1/4 x 1 1/2 20 Pieces	29031 5/16 x 1 1/2 20 Pieces	29056 3/8 x 1 1/2 20 Pieces	29083 7/16 x 2 10 Pieces	29110 1/2 x 2 1/2 10 Pieces			
29008 1/4 x 2 20 Pieces	29033 5/16 x 2 20 Pieces	29058 3/8 x 2 20 Pieces	29085 7/16 x 2 1/2 10 Pieces	29112 1/2 x 3 10 Pieces			
29010 1/4 x 2 1/2 20 Pieces	29035 5/16 x 2 1/2 20 Pieces	29060 3/8 x 2 1/2 20 Pieces	29087 7/16 x 3 10 Pieces	29116 1/2 x 4 10 Pieces			
29012 1/4 x 3 20 Pieces	29037 5/16 x 3 20 Pieces	29062 3/8 x 3 20 Pieces	29091 7/16 x 4 10 Pieces				

SOCKET CAP SCREW

CD - 704

Assortment includes:
72 bin (99908)
****Stand is extra****

Label Sets Required:
 LB-925 High Lockwashers
 LB-951 Socket Cap Screw

37771 1/4 100 Pieces	37772 5/16 100 Pieces	37773 3/8 100 Pieces	37774 7/16 100 Pieces	37775 1/2 50 Pieces	37777 5/8 50 Pieces	37778 3/4 50 Pieces	
29000 1/4 x 1/2 20 Pieces	29025 5/16 x 1/2 20 Pieces	29050 3/8 x 1/2 20 Pieces	29077 7/16 x 3/4 10 Pieces	29103 1/2 x 3/4 10 Pieces	29145 5/8 x 1 10 Pieces	29170 3/4 x 1-1/2 10 Pieces	
29002 1/4 x 3/4 20 Pieces	29027 5/16 x 3/4 20 Pieces	29052 3/8 x 3/4 20 Pieces	29079 7/16 x 1 10 Pieces	29104 1/2 x 1 10 Pieces	29146 5/8 x 1 1/4 10 Pieces	29171 3/4 x 1-3/4 10 Pieces	
29004 1/4 x 1 20 Pieces	29029 5/16 x 1 20 Pieces	29054 3/8 x 1 20 Pieces	29080 7/16 x 1 1/4 10 Pieces	29106 1/2 x 1 1/2 10 Pieces	29147 5/8 x 1 1/2 10 Pieces	29172 3/4 x 2 10 Pieces	
29005 1/4 x 1 1/4 20 Pieces	29030 5/16 x 1 1/4 20 Pieces	29055 3/8 x 1 1/4 20 Pieces	29081 7/16 x 1 1/2 10 Pieces	29108 1/2 x 2 10 Pieces	29149 5/8 x 2 5 Pieces	29173 3/4 x 2 1/4 10 Pieces	
29006 1/4 x 1 1/2 20 Pieces	29031 5/16 x 1 1/2 20 Pieces	29056 3/8 x 1 1/2 20 Pieces	29083 7/16 x 2 10 Pieces	29110 1/2 x 2 1/2 10 Pieces	29151 5/8 x 2 1/2 5 Pieces	29174 3/4 x 2-1/2 5 Pieces	
29008 1/4 x 2 20 Pieces	29033 5/16 x 2 20 Pieces	29058 3/8 x 2 20 Pieces	29085 7/16 x 2 1/2 10 Pieces	29112 1/2 x 3 10 Pieces	29153 5/8 x 3 5 Pieces	29176 3/4 x 3 5 Pieces	
29010 1/4 x 2 1/2 20 Pieces	29035 5/16 x 2 1/2 20 Pieces	29060 3/8 x 2 1/2 20 Pieces	29087 7/16 x 3 10 Pieces	29116 1/2 x 4 10 Pieces	29157 5/8 x 4 5 Pieces	29180 3/4 x 4 5 Pieces	
29012 1/4 x 3 20 Pieces	29037 5/16 x 3 20 Pieces	29062 3/8 x 3 20 Pieces	29091 7/16 x 4 10 Pieces	29118 1/2 x 5	29159 5/8 x 5 5 Pieces	29182 3/4 x 5 5 Pieces	

For NYTA include the label only.
 For all other accounts keep this spot blank.

MINI MAINTENANCE ASST.

CD - 705

Assortment includes:
32 bin (99909)
****Stand is extra****

Label Sets Required: LB-963 Maintenance Asst.

15002 100 Pieces	15004 100 Pieces	15006 100 Pieces	15009 25 Pieces	15010 25 Pieces	15011 25 Pieces	15012 25 Pieces	15020 100 Pieces
15022 100 Pieces	15024 100 Pieces	15151 25 Pieces	15153 25 Pieces	15155 25 Pieces	15156 25 Pieces	15157 10 Pieces	15158 10 Pieces
15181 25 Pieces	15185 25 Pieces	15186 25 Pieces	15188 25 Pieces	15189 25 Pieces	15190 25 Pieces	15191 25 Pieces	15193 25 Pieces
15194 25 Pieces	15195 10 Pieces	15196 10 Pieces	15350 25 Pieces	15351 10 Pieces	15352 10 Pieces	15353 5 Pieces	15354 5 Pieces

S/S MAINTENANCE ASST. CD - 706

Assortment includes:

72 bin (99908)

40 bin (99927)

****Stand is extra****

Label Sets Required: LB-964 SS Maintenance Asst.

15002 100 Pieces	15004 100 Pieces	15006 100 Pieces	15009 25 Pieces	15010 25 Pieces	15011 25 Pieces	15012 25 Pieces	
15020 100 Pieces	15022 100 Pieces	15024 100 Pieces	15150 25 Pieces	15151 25 Pieces	15152 25 Pieces	15153 25 Pieces	15154 25 Pieces
15155 25 Pieces	15156 25 Pieces	15157 10 Pieces	15158 10 Pieces	15180 25 Pieces	15181 25 Pieces	15185 25 Pieces	15186 25 Pieces
15188 25 Pieces	15189 25 Pieces	15190 25 Pieces	15191 25 Pieces	15192 25 Pieces	15193 25 Pieces	15194 25 Pieces	15195 10 Pieces
15196 10 Pieces	52100 12 Pieces	52102 12 Pieces	52103 12 Pieces	52105 12 Pieces	52106 5 Pieces	52107 5 Pieces	52109 5 Pieces
52110 5 Pieces	52111 3 Pieces	52113 3 Pieces	52114 3 Pieces	52115 3 Pieces	52117 3 Pieces		
15350 25 Pieces	15351 10 Pieces	15352 10 Pieces	15353 5 Pieces	15354 5 Pieces	35210 10 Pieces	35211 10 Pieces	35212 10 Pieces
35213 10 Pieces	35214 10 Pieces	35215 10 Pieces	35216 5 Pieces	35217 5 Pieces	35218 5 Pieces	35219 5 Pieces	52200 12 Pieces
52202 12 Pieces	52204 12 Pieces	52206 12 Pieces	52210 12 Pieces	52220 12 Pieces	52222 12 Pieces	52224 12 Pieces	52226 12 Pieces
52228 12 Pieces		52442 12 Pieces	52444 5 Pieces	52446 5 Pieces	52448 5 Pieces	52450 5 Pieces	52461 5 Pieces
52463 5 Pieces	52465 5 Pieces	52466 3 Pieces	52467 3 Pieces	52480 3 Pieces	52482 3 Pieces	52483 3 Pieces	52486 3 Pieces
35022 25 Pieces	35024 25 Pieces	35026 25 Pieces	35028 25 Pieces	35044 25 Pieces	35046 25 Pieces	35048 25 Pieces	35050 25 Pieces
35064 25 Pieces	35066 25 Pieces	35068 10 Pieces	35070 10 Pieces	35104 10 Pieces	35106 10 Pieces	35108 10 Pieces	35110 10 Pieces
35111 10 Pieces	35112 5 Pieces						

COTTER PIN ASST.

CD - 712

Assortment includes:
40 bin (99927)
****Stand is extra****

Label Sets Required: LB-960 Cotter Pins

48212 100 Pcs.	48214 100 Pcs.	48216 100 Pcs.	48217 100 Pcs.	48222 100 Pcs.	48223 100 Pcs.	48225 100 Pcs.	48226 100 Pcs.
48228 100 Pcs.	48229 100 Pcs.	48230 100 Pcs.	48231 100 Pcs.	48234 100 Pcs.	48235 100 Pcs.	48238 100 Pcs.	48239 100 Pcs.
48241 100 Pcs.	48244 100 Pcs.	48248 100 Pcs.	48249 100 Pcs.	48250 100 Pcs.	48252 100 Pcs.	48253 100 Pcs.	48254 100 Pcs.
48256 100 Pcs.	48257 100 Pcs.	48260 100 Pcs.	48262 100 Pcs.	48263 100 Pcs.	48265 100 Pcs.	48267 100 Pcs.	48272 100 Pcs.
48275 100 Pcs.	48276 100 Pcs.	48278 100 Pcs.	48279 100 Pcs.				

CD – 1261 PIPE BRASS ASSORTMENT
(99930 BIN)
2 PCS EACH.
Label Set Required: LB-937

TOP ROW					
Pipe Cap & Pipe Slotted Plug	Square Head Pipe Plug	Hex Head Pipe Plug	Pipe Adapter	Pipe Bushing	Pipe Coupling & Pipe Union
90206	90214	90224	90237	90247	90251
			90236	90246	
			90235	90245	90250
			90234	90244	90256
90205			90233	90243	90255
90204-1	90213	90223	90233	90243	90255
90204	90212	90222	90232	90242	90254
90203	90211	90221	90231	90241	90253
90201	90210	90220	90230	90240	90252

MIDDLE ROW					
Pipe Reducing Coupling	Hex Nipple	Long Nipple	Long Nipple	Long Nipple	45° Pipe Street Elbow
90260	90272	90298	90311	90312	90329
	90271				
	90270	90297	90310		
	90268	90296	90303		90328
90259	90267	90295	90302	90313	90327
90258	90266	90291	90301	90320	90326
90257	90265	90290	90300	90321	90325

BOTTOM ROW					
Pipe Street Elbow	Pipe Elbow	Male Pipe Branch Tee	Pipe Tee	Pipe Street Tee	Pipe Cross
90339	90349	90359	90369	90379	90389
90338	90348	90358	90368	90378	90388
90337	90347	90357	90367	90377	90387
90336	90346	90356	90366	90376	90386
90335	90345	90355	90365	90375	90385

CD – 1262 FLARE BRASS ASSORTMENT
(99930 BIN)
2 PCS EACH.
 Require Label Set: LB-938

TOP ROW					
SAE 45° Flare Long Nut	SAE 45° Flare Nut	SAE 45° Flare Union	SAE 45° Flare Union Tee	SAE 45° Flare Male Branch Tee	SAE 45° Flare Female Connector
	90416			90445	
90406	90415	90428		90444	
	90414	90427		90443	90456
	90413	90426	90435	90442	90455
90405	90412	90425	90434	90441	90454
90404	90410	90424	90433	90440	90453
90403	90409	90423	90432	90439	90452
90402	90408	90422	90431	90438	90451
90401	90407	90421	90430	90437	90450

MIDDLE ROW					
SAE 45° Flare Female Connector	SAE 45° Flare Male Connector	SAE 45° Flare Male Connector	SAE 45° Flare Male Connector	SAE 45° Flare Male Elbow	SAE 45° Flare Male Elbow
				90492	
			90482	90491	90499
90462	90470		90481	90490	90498
90461	90469		90480	90489	90497
90460	90468	90474	90479	90488	
90459	90467	90473	90478	90487	90495
90458	90466	90472	90477	90486	90494
90457	90465	90471	90476	90485	90493

BOTTOM ROW					
SAE 45° Flare Male Elbow	SAE 45° Flare Female Elbow	SAE 45° Flare Male Run Tee	SAE 45° Flare Male Run Tee	SAE 45° Flare 45° Male Elbow	SAE 45° Flare Union Elbow
	90513				
	90512				
	90511				
	90509	90519		90529	90534
90504	90508	90518	90523	90528	90533
90503	90507	90517	90522	90527	90532
90502	90506	90516	90521	90526	90531
90501	90505	90515	90520	90525	90530

CD – 1263 COMPRESSION BRASS ASSORTMENT
(99930 BIN)
2 PCS EACH.

Label Set Required: LB-939

TOP ROW				
Comp. Sleeve	Comp. Nut	Comp. Long Nut	Comp. Union	Comp. Union Tee
90059				
90058	90068	90077	90088	
90057	90067	90076	90087	
90056	90066	90075	90086	
90055	90064	90074	90084	90094
90054	90063	90073	90083	90093
90053	90062	90072	90082	90092
90052	90061	90071	90081	90091
90051	90060	90070	90080	90090

MIDDLE ROW					
Comp. Union Elbow	Comp. Female Connector	Comp. Female Connector	Comp. Male Connector	Comp. Male Connector	Comp. Male Connector
			90116		
90099	90105	90110	90115	90121	90127
90098	90104	90109	90114	90120	90126
90097	90103	90108	90113	90119	90125
90096	90102	90107	90112	90118	90124
90095	90101	90106	90111	90117	90123

BOTTOM ROW					
Comp. Male Elbow	Comp. Male Elbow	Comp. Male Elbow	Comp. Female Elbow	Comp. Male Run Tee	Comp. Male Branch Tee
			90155	90165	90171
90135	90140	90146	90154	90164	90170
90134	90139	90145	90153	90163	90169
90133	90138	90144	90152	90162	90168
90132	90137	90143	90151	90161	90167
90130	90136	90142	90150	90160	90166

**CD – 1264 INVERTED FLARE BRASS ASSORTMENT
(99930 BIN)
2 PCS EACH.**

Label Sets Required: LB-940 & LB-941

TOP ROW					
Inverted Flare Nut	Inverted Flare Male Connector	Inverted Flare Female Connector	Inverted Flare Union	Inverted Flare 45° Male Elbow	Inverted Flare Male Elbow
	90572				
	90570				
	90569				
90558	90568			90608	
90557	90567	90585	90595		90615
90555	90566	90584	90594	90605	90614
90554	90565	90583	90593		90613
90553	90564	90582	90592	90603	90612
90552	90563	90581	90591	90602	90611
90551	90562	90580	90590	90601	90610

MIDDLE ROW					
Inverted Flare Male Elbow	Sleeve	Union	Female Connector	90° Male Elbow	90° Male Elbow
90627					
90626					
90624			90817	90828	
90623	90805	90810-1	90816	90827	90833
90622	90804	90810	90815	90826	90832
90621	90803	90809	90814	90825	90831
90619	90802	90808	90813	90824	90830
90618	90801	90807	90812	90823	90829

BOTTOM ROW					
45° Male Elbow	Nut	Union Tee	Male Connector	Male Connector	Insert
90846			90873		
90845	90854		90872	90878	90894
90844	90853	90859	90871	90877	90893
90843	90852	90858	90870	90876	90892
90841	90851	90857	90869	90875	90891
90840	90850	90856	90868	90874	90890

Custom Assortment Pick Sheets

P - Clamp

CUSTOM

in 40 bin (99927)

37532 3/8 10 Pieces	37533 1/2 10 Pieces	37535 3/4 10 Pieces	37536 7/8 10 Pieces	37537 1 10 Pieces	37538 1 1/8 10 Pieces	37541 1 1/2 10 Pieces	37543 1 3/4 10 Pieces
37544 1 7/8 10 Pieces	37545 2 10 Pieces	37546 2 1/8 10 Pieces	37547 2 1/4 10 Pieces	37548 2 3/8 10 Pieces	37549 2 1/2 10 Pieces	37550 2 5/8 10 Pieces	37551 2 3/4 10 Pieces
50052 3/8 x 3/4 Cap Screw 10 Pieces	50054 3/8 x 1 Cap Screw 10 Pieces	50055 3/8 x 1 1/4 Cap Screw 10 Pieces	60603 3/8 Nut 10 Pieces	60703 3/8 Flatwasher 10 Pieces	60753 3/8 Lockwasher 10 Pieces		

CD-508 - Custom w/ Nylocks
GRADE 5 USS 1/4 to 3/4

Label Sets:

LB-901
LB-910
LB-907
LB-904
LB-915
LB-908

CD-355
Nylocks

CD-800
High Hex Nuts

*

*

*

31651 Nut 1/4 100 Pieces	31652 Nut 5/16 100 Pieces	31653 Nut 3/8 100 Pieces	31654 Nut 7/16 50 Pieces	31655 Nut 1/2 50 Pieces	31656 Nut 9/16 25 Pieces	31657 Nut 5/8 25 Pieces	31658 Nut 3/4 25 Pieces
38751 L. Washer 1/4 100 Pieces	38752 L. Washer 5/16 100 Pieces	38753 L. Washer 3/8 100 Pieces	38754 L. Washer 7/16 100 Pieces	38755 L. Washer 1/2 50 Pieces	38756 L. Washer 9/16 50 Pieces	38757 L. Washer 5/8 25 Pieces	38758 L. Washer 3/4 25 Pieces
71801 Nylock 1/4 100 Pieces	71802 Nylock 5/16 100 Pieces	71803 Nylock 3/8 100 Pieces	71804 Nylock 7/16 100 Pieces	71805 Nylock 1/2 50 Pieces	71806 Nylock 9/16 50 Pieces	71807 Nylock 5/8 25 Pieces	71808 Nylock 3/4 25 Pieces
38701 Washer 1/4 200 Pieces	38702 Washer 5/16 200 Pieces	38703 Washer 3/8 100 Pieces	38704 Washer 7/16 100 Pieces	38705 Washer 1/2 50 Pieces	38706 Washer 9/16 25 Pieces	38707 Washer 5/8 25 Pieces	38708 Washer 3/4 25 Pieces
37851 High Hex 1/4 100 Pieces	37852 High Hex 5/16 100 Pieces	37853 High Hex 3/8 100 Pieces	37854 High Hex 7/16 50 Pieces	37855 High Hex 1/2 50 Pieces	37856 High Hex 9/16 25 Pieces	37857 High Hex 5/8 25 Pieces	37858 High Hex 3/4 25 Pieces

40 Bin

LABEL ONLY

31000 1/4 x 1/2 20 Pieces	31027 5/16 x 3/4 20 Pieces	31052 3/8 x 3/4 20 Pieces	31077 7/16 x 3/4 10 Pieces	31104 1/2 x 1 10 Pieces	31130 9/16 x 1 10 Pieces	31152 5/8 x 1 1/2 10 Pieces	31169 3/4 x 2 10 Pieces
31002 1/4 x 3/4 20 Pieces	31029 5/16 x 1 20 Pieces	31054 3/8 x 1 20 Pieces	31079 7/16 x 1 10 Pieces	31106 1/2 x 1 1/2 10 Pieces	31131 9/16 x 1 1/2 10 Pieces	31154 5/8 x 2 5 Pieces	31172 3/4 x 2 1/2 10 Pieces
31003 1/4 x 1 20 Pieces	31030 5/16 x 1 1/4 20 Pieces	31055 3/8 x 1 1/4 20 Pieces	31081 7/16 x 1 1/2 10 Pieces	31108 1/2 x 2 10 Pieces	31133 9/16 x 2 10 Pieces	31156 5/8 x 2 1/2 5 Pieces	31174 3/4 x 3 5 Pieces
31004 1/4 x 1 1/4 20 Pieces	31031 5/16 x 1 1/2 20 Pieces	31056 3/8 x 1 1/2 20 Pieces	31083 7/16 x 2 10 Pieces	31110 1/2 x 2 1/2 10 Pieces	31135 9/16 x 2 1/2 5 Pieces	31158 5/8 x 3 5 Pieces	31174-1 3/4 x 3 1/2 5 Pieces
31005 1/4 x 1 1/2 20 Pieces	31033 5/16 x 2 20 Pieces	31058 3/8 x 2 20 Pieces	31085 7/16 x 2 1/2 10 Pieces	31112 1/2 x 3 10 Pieces	31137 9/16 x 3 5 Pieces	31159 5/8 x 3 1/2 5 Pieces	31175 3/4 x 4 5 Pieces
31007 1/4 x 2 20 Pieces	31035 5/16 x 2 1/2 20 Pieces	31060 3/8 x 2 1/2 20 Pieces	31087 7/16 x 3 10 Pieces	31116 1/2 x 4 10 Pieces	31139 9/16 x 3 1/2 5 Pieces	31160 5/8 x 4 5 Pieces	31176 3/4 x 4 1/2 5 Pieces
31009 1/4 x 2 1/2 20 Pieces	31037 5/16 x 3 20 Pieces	31062 3/8 x 3 20 Pieces	31089 7/16 x 3 1/2 10 Pieces	31117 1/2 x 4 1/2 10 Pieces	31141 9/16 x 4 5 Pieces	31161 5/8 x 4 1/2 5 Pieces	31177 3/4 x 5 5 Pieces
31012 1/4 x 3 20 Pieces	31040 5/16 x 4 20 Pieces	31066 3/8 x 4 20 Pieces	31091 7/16 x 4 10 Pieces	31118 1/2 x 5 10 Pieces	31143 9/16 x 5 5 Pieces	31162 5/8 x 5 5 Pieces	31178 3/4 x 5 1/2 5 Pieces
31016 1/4 x 4 20 Pieces	31042 5/16 x 5 20 Pieces	31068 3/8 x 5 20 Pieces	31093 7/16 x 5 10 Pieces	31120 1/2 x 6 10 Pieces	31146 9/16 x 6 5 Pieces	31164 5/8 x 6 5 Pieces	31179 3/4 x 6 5 Pieces

72 Bin

CD-508 - Custom w/ Prevailing Torque Nuts
GRADE 5 USS 1/4 to 3/4

Label Sets:

LB-901
LB-910
LB-907
LB-904
LB-917
LB-908



CD-357 *
Torque Nuts



CD-800
High Hex Nuts

31651 Nut 1/4 100 Pieces	31652 Nut 5/16 100 Pieces	31653 Nut 3/8 100 Pieces	31654 Nut 7/16 50 Pieces	31655 Nut 1/2 50 Pieces	31656 Nut 9/16 25 Pieces	31657 Nut 5/8 25 Pieces	31658 Nut 3/4 25 Pieces
38751 L. Washer 1/4 100 Pieces	38752 L. Washer 5/16 100 Pieces	38753 L. Washer 3/8 100 Pieces	38754 L. Washer 7/16 100 Pieces	38755 L. Washer 1/2 50 Pieces	38756 L. Washer 9/16 50 Pieces	38757 L. Washer 5/8 25 Pieces	38758 L. Washer 3/4 25 Pieces
37780 Torq Nut 1/4 100 Pieces	37781 Torq Nut 5/16 100 Pieces	37782 Torq Nut 3/8 100 Pieces	37783 Torq Nut 7/16 50 Pieces	37784 Torq Nut 1/2 50 Pieces	37785 Torq Nut 9/16 50 Pieces	37786 Torq Nut 5/8 25 Pieces	37787 Torq Nut 3/4 25 Pieces
38701 Washer 1/4 200 Pieces	38702 Washer 5/16 200 Pieces	38703 Washer 3/8 100 Pieces	38704 Washer 7/16 100 Pieces	38705 Washer 1/2 50 Pieces	38706 Washer 9/16 25 Pieces	38707 Washer 5/8 25 Pieces	38708 Washer 3/4 25 Pieces
37851 High Hex 1/4 100 Pieces	37852 High Hex 5/16 100 Pieces	37853 High Hex 3/8 100 Pieces	37854 High Hex 7/16 50 Pieces	37855 High Hex 1/2 50 Pieces	37856 High Hex 9/16 25 Pieces	37857 High Hex 5/8 25 Pieces	37858 High Hex 3/4 25 Pieces

40 Bin

LABEL ONLY

31000 1/4 x 1/2 20 Pieces	31027 5/16 x 3/4 20 Pieces	31052 3/8 x 3/4 20 Pieces	31077 7/16 x 3/4 10 Pieces	31104 1/2 x 1 10 Pieces	31130 9/16 x 1 10 Pieces	31152 5/8 x 1 1/2 10 Pieces	31169 3/4 x 2 10 Pieces
31002 1/4 x 3/4 20 Pieces	31029 5/16 x 1 20 Pieces	31054 3/8 x 1 20 Pieces	31079 7/16 x 1 10 Pieces	31106 1/2 x 1 1/2 10 Pieces	31131 9/16 x 1 1/2 10 Pieces	31154 5/8 x 2 5 Pieces	31172 3/4 x 2 1/2 10 Pieces
31003 1/4 x 1 20 Pieces	31030 5/16 x 1 1/4 20 Pieces	31055 3/8 x 1 1/4 20 Pieces	31081 7/16 x 1 1/2 10 Pieces	31108 1/2 x 2 10 Pieces	31133 9/16 x 2 10 Pieces	31156 5/8 x 2 1/2 5 Pieces	31174 3/4 x 3 5 Pieces
31004 1/4 x 1 1/4 20 Pieces	31031 5/16 x 1 1/2 20 Pieces	31056 3/8 x 1 1/2 20 Pieces	31083 7/16 x 2 10 Pieces	31110 1/2 x 2 1/2 10 Pieces	31135 9/16 x 2 1/2 5 Pieces	31158 5/8 x 3 5 Pieces	31174-1 3/4 x 3 1/2 5 Pieces
31005 1/4 x 1 1/2 20 Pieces	31033 5/16 x 2 20 Pieces	31058 3/8 x 2 20 Pieces	31085 7/16 x 2 1/2 10 Pieces	31112 1/2 x 3 10 Pieces	31137 9/16 x 3 5 Pieces	31159 5/8 x 3 1/2 5 Pieces	31175 3/4 x 4 5 Pieces
31007 1/4 x 2 20 Pieces	31035 5/16 x 2 1/2 20 Pieces	31060 3/8 x 2 1/2 20 Pieces	31087 7/16 x 3 10 Pieces	31116 1/2 x 4 10 Pieces	31139 9/16 x 3 1/2 5 Pieces	31160 5/8 x 4 5 Pieces	31176 3/4 x 4 1/2 5 Pieces
31009 1/4 x 2 1/2 20 Pieces	31037 5/16 x 3 20 Pieces	31062 3/8 x 3 20 Pieces	31089 7/16 x 3 1/2 10 Pieces	31117 1/2 x 4 1/2 10 Pieces	31141 9/16 x 4 5 Pieces	31161 5/8 x 4 1/2 5 Pieces	31177 3/4 x 5 5 Pieces
31012 1/4 x 3 20 Pieces	31040 5/16 x 4 20 Pieces	31066 3/8 x 4 20 Pieces	31091 7/16 x 4 10 Pieces	31118 1/2 x 5 10 Pieces	31143 9/16 x 5 5 Pieces	31162 5/8 x 5 5 Pieces	31178 3/4 x 5 1/2 5 Pieces
31016 1/4 x 4 20 Pieces	31042 5/16 x 5 20 Pieces	31068 3/8 x 5 20 Pieces	31093 7/16 x 5 10 Pieces	31120 1/2 x 6 10 Pieces	31146 9/16 x 6 5 Pieces	31164 5/8 x 6 5 Pieces	31179 3/4 x 6 5 Pieces

72 Bin

CD-509 - Custom w/ Prevailing Torque Nuts
GRADE 5 SAE 1/4 to 3/4

Label Sets:

LB-911
LB-918
LB-907
LB-903
LB-909
LB-902

CD-357 *
Torque Nuts *

CD-801 *
High Hex Nuts *

31671 Nut 1/4 100 Pieces	31672 Nut 5/16 100 Pieces	31673 Nut 3/8 100 Pieces	31674 Nut 7/16 50 Pieces	31675 Nut 1/2 50 Pieces	31676 Nut 9/16 25 Pieces	31677 Nut 5/8 25 Pieces	31678 Nut 3/4 25 Pieces
38751 L. Washer 1/4 100 Pieces	38752 L. Washer 5/16 100 Pieces	38753 L. Washer 3/8 100 Pieces	38754 L. Washer 7/16 100 Pieces	38755 L. Washer 1/2 50 Pieces	38756 L. Washer 9/16 50 Pieces	38757 L. Washer 5/8 25 Pieces	38758 L. Washer 3/4 25 Pieces
37795 Torq Nut 1/4 100 Pieces	37796 Torq Nut 5/16 100 Pieces	37797 Torq Nut 3/8 100 Pieces	37798 Torq Nut 7/16 50 Pieces	37799 Torq Nut 1/2 50 Pieces	37800 Torq Nut 9/16 50 Pieces	37801 Torq Nut 5/8 25 Pieces	37802 Torq Nut 3/4 25 Pieces
38721 Washer 1/4 200 Pieces	38722 Washer 5/16 200 Pieces	38723 Washer 3/8 100 Pieces	38724 Washer 7/16 100 Pieces	38725 Washer 1/2 50 Pieces	38726 Washer 9/16 25 Pieces	38727 Washer 5/8 25 Pieces	38728 Washer 3/4 25 Pieces
37871 High Hex 1/4 100 Pieces	37872 High Hex 5/16 100 Pieces	37873 High Hex 3/8 100 Pieces	37874 High Hex 7/16 50 Pieces	37875 High Hex 1/2 50 Pieces	37876 High Hex 9/16 25 Pieces	37877 High Hex 5/8 25 Pieces	37878 High Hex 3/4 25 Pieces

40 Bin

LABEL ONLY

31301 1/4 x 1/2 20 Pieces	31327 5/16 x 3/4 20 Pieces	31352 3/8 x 3/4 20 Pieces	31377 7/16 x 3/4 10 Pieces	31404 1/2 x 1 10 Pieces	31430 9/16 x 1 10 Pieces	31452 5/8 x 1 1/2 10 Pieces	31469 3/4 x 2 10 Pieces
31302 1/4 x 3/4 20 Pieces	31329 5/16 x 1 20 Pieces	31354 3/8 x 1 20 Pieces	31379 7/16 x 1 10 Pieces	31406 1/2 x 1 1/2 10 Pieces	31431 9/16 x 1 1/2 10 Pieces	31454 5/8 x 2 5 Pieces	31472 3/4 x 2 1/2 10 Pieces
31303 1/4 x 1 20 Pieces	31330 5/16 x 1 1/4 20 Pieces	31355 3/8 x 1 1/4 20 Pieces	31381 7/16 x 1 1/2 10 Pieces	31408 1/2 x 2 10 Pieces	31433 9/16 x 2 10 Pieces	31456 5/8 x 2 1/2 5 Pieces	31474 3/4 x 3 5 Pieces
31304 1/4 x 1 1/4 20 Pieces	31331 5/16 x 1 1/2 20 Pieces	31356 3/8 x 1 1/2 20 Pieces	31383 7/16 x 2 10 Pieces	31410 1/2 x 2 1/2 10 Pieces	31435 9/16 x 2 1/2 5 Pieces	31458 5/8 x 3 5 Pieces	31475 3/4 x 3 1/2 5 Pieces
31305 1/4 x 1 1/2 20 Pieces	31333 5/16 x 2 20 Pieces	31358 3/8 x 2 20 Pieces	31385 7/16 x 2 1/2 10 Pieces	31412 1/2 x 3 10 Pieces	31437 9/16 x 3 5 Pieces	31459 5/8 x 3 1/2 5 Pieces	31475-1 3/4 x 4 5 Pieces
31307 1/4 x 2 20 Pieces	31335 5/16 x 2 1/2 20 Pieces	31360 3/8 x 2 1/2 20 Pieces	31387 7/16 x 3 10 Pieces	31416 1/2 x 4 10 Pieces	31439 9/16 x 3 1/2 5 Pieces	31460 5/8 x 4 5 Pieces	31476 3/4 x 4 1/2 5 Pieces
31309 1/4 x 2 1/2 20 Pieces	31337 5/16 x 3 20 Pieces	31362 3/8 x 3 20 Pieces	31389 7/16 x 3 1/2 10 Pieces	31417 1/2 x 4 1/2 10 Pieces	31441 9/16 x 4 5 Pieces	31461 5/8 x 4 1/2 5 Pieces	31477 3/4 x 5 5 Pieces
31312 1/4 x 3 20 Pieces	31340 5/16 x 4 20 Pieces	31366 3/8 x 4 20 Pieces	31391 7/16 x 4 10 Pieces	31418 1/2 x 5 10 Pieces	31443 9/16 x 5 5 Pieces	31462 5/8 x 5 5 Pieces	31478 3/4 x 5 1/2 5 Pieces
31316 1/4 x 4 20 Pieces	31342 5/16 x 5 20 Pieces	31368 3/8 x 5 20 Pieces	31393 7/16 x 5 10 Pieces	31420 1/2 x 6 10 Pieces	31446 9/16 x 6 5 Pieces	31464 5/8 x 6 5 Pieces	31479 3/4 x 6 5 Pieces

72 Bin

CD-509 - Custom w/ Nylocks
GRADE 5 SAE 1/4 to 3/4

Label Sets:

LB-911
LB-916
LB-907
LB-903
LB-909
LB-902

CD-356
Nylocks

CD-801
High Hex Nuts

*

*

*

31671 Nut 1/4 100 Pieces	31672 Nut 5/16 100 Pieces	31673 Nut 3/8 100 Pieces	31674 Nut 7/16 50 Pieces	31675 Nut 1/2 50 Pieces	31676 Nut 9/16 25 Pieces	31677 Nut 5/8 25 Pieces	31678 Nut 3/4 25 Pieces
38751 L. Washer 1/4 100 Pieces	38752 L. Washer 5/16 100 Pieces	38753 L. Washer 3/8 100 Pieces	38754 L. Washer 7/16 100 Pieces	38755 L. Washer 1/2 50 Pieces	38756 L. Washer 9/16 50 Pieces	38757 L. Washer 5/8 25 Pieces	38758 L. Washer 3/4 25 Pieces
71821 Nylock 1/4 100 Pieces	71822 Nylock 5/16 100 Pieces	71823 Nylock 3/8 100 Pieces	71824 Nylock 7/16 100 Pieces	71825 Nylock 1/2 50 Pieces	71826 Nylock 9/16 50 Pieces	71827 Nylock 5/8 25 Pieces	71828 Nylock 3/4 25 Pieces
38721 Washer 1/4 200 Pieces	38722 Washer 5/16 200 Pieces	38723 Washer 3/8 100 Pieces	38724 Washer 7/16 100 Pieces	38725 Washer 1/2 50 Pieces	38726 Washer 9/16 25 Pieces	38727 Washer 5/8 25 Pieces	38728 Washer 3/4 25 Pieces
37871 High Hex 1/4 100 Pieces	37872 High Hex 5/16 100 Pieces	37873 High Hex 3/8 100 Pieces	37874 High Hex 7/16 50 Pieces	37875 High Hex 1/2 50 Pieces	37876 High Hex 9/16 25 Pieces	37877 High Hex 5/8 25 Pieces	37878 High Hex 3/4 25 Pieces

40 Bin

LABEL ONLY

31301 1/4 x 1/2 20 Pieces	31327 5/16 x 3/4 20 Pieces	31352 3/8 x 3/4 20 Pieces	31377 7/16 x 3/4 10 Pieces	31404 1/2 x 1 10 Pieces	31430 9/16 x 1 10 Pieces	31452 5/8 x 1 1/2 10 Pieces	31469 3/4 x 2 10 Pieces
31302 1/4 x 3/4 20 Pieces	31329 5/16 x 1 20 Pieces	31354 3/8 x 1 20 Pieces	31379 7/16 x 1 10 Pieces	31406 1/2 x 1 1/2 10 Pieces	31431 9/16 x 1 1/2 10 Pieces	31454 5/8 x 2 5 Pieces	31472 3/4 x 2 1/2 10 Pieces
31303 1/4 x 1 20 Pieces	31330 5/16 x 1 1/4 20 Pieces	31355 3/8 x 1 1/4 20 Pieces	31381 7/16 x 1 1/2 10 Pieces	31408 1/2 x 2 10 Pieces	31433 9/16 x 2 10 Pieces	31456 5/8 x 2 1/2 5 Pieces	31474 3/4 x 3 5 Pieces
31304 1/4 x 1 1/4 20 Pieces	31331 5/16 x 1 1/2 20 Pieces	31356 3/8 x 1 1/2 20 Pieces	31383 7/16 x 2 10 Pieces	31410 1/2 x 2 1/2 10 Pieces	31435 9/16 x 2 1/2 5 Pieces	31458 5/8 x 3 5 Pieces	31475 3/4 x 3 1/2 5 Pieces
31305 1/4 x 1 1/2 20 Pieces	31333 5/16 x 2 20 Pieces	31358 3/8 x 2 20 Pieces	31385 7/16 x 2 1/2 10 Pieces	31412 1/2 x 3 10 Pieces	31437 9/16 x 3 5 Pieces	31459 5/8 x 3 1/2 5 Pieces	31475-1 3/4 x 4 5 Pieces
31307 1/4 x 2 20 Pieces	31335 5/16 x 2 1/2 20 Pieces	31360 3/8 x 2 1/2 20 Pieces	31387 7/16 x 3 10 Pieces	31416 1/2 x 4 10 Pieces	31439 9/16 x 3 1/2 5 Pieces	31460 5/8 x 4 5 Pieces	31476 3/4 x 4 1/2 5 Pieces
31309 1/4 x 2 1/2 20 Pieces	31337 5/16 x 3 20 Pieces	31362 3/8 x 3 20 Pieces	31389 7/16 x 3 1/2 10 Pieces	31417 1/2 x 4 1/2 10 Pieces	31441 9/16 x 4 5 Pieces	31461 5/8 x 4 1/2 5 Pieces	31477 3/4 x 5 5 Pieces
31312 1/4 x 3 20 Pieces	31340 5/16 x 4 20 Pieces	31366 3/8 x 4 20 Pieces	31391 7/16 x 4 10 Pieces	31418 1/2 x 5 10 Pieces	31443 9/16 x 5 5 Pieces	31462 5/8 x 5 5 Pieces	31478 3/4 x 5 1/2 5 Pieces
31316 1/4 x 4 20 Pieces	31342 5/16 x 5 20 Pieces	31368 3/8 x 5 20 Pieces	31393 7/16 x 5 10 Pieces	31420 1/2 x 6 10 Pieces	31446 9/16 x 6 5 Pieces	31464 5/8 x 6 5 Pieces	31479 3/4 x 6 5 Pieces

72 Bin

CD-534 - Custom w/ Prevailing Torque Nuts
GRADE 8 USS 1/4 to 3/4

Label Sets:

LB-905
LB-907
LB-917
LB-903
LB-908
LB-912

CD-357 *
Torque Nuts

*

CD-800
High Hex Nuts

40601 Nut 1/4 100 Pieces	40602 Nut 5/16 100 Pieces	40603 Nut 3/8 100 Pieces	40604 Nut 7/16 50 Pieces	40605 Nut 1/2 50 Pieces	40606 Nut 9/16 25 Pieces	40607 Nut 5/8 25 Pieces	40608 Nut 3/4 25 Pieces
40751 L. Washer 1/4 100 Pieces	40752 L. Washer 5/16 100 Pieces	40753 L. Washer 3/8 100 Pieces	40754 L. Washer 7/16 100 Pieces	40755 L. Washer 1/2 50 Pieces	40756 L. Washer 9/16 50 Pieces	40757 L. Washer 5/8 25 Pieces	40758 L. Washer 3/4 25 Pieces
37780 Lock Nuts 1/4 100 Pieces	37781 Lock Nuts 5/16 100 Pieces	37782 Lock Nuts 3/8 100 Pieces	37783 Lock Nuts 7/16 100 Pieces	37784 Lock Nuts 1/2 50 Pieces	37785 Lock Nuts 9/16 50 Pieces	37786 Lock Nuts 5/8 25 Pieces	37787 Lock Nuts 3/4 25 Pieces
38721 Washer 1/4 200 Pieces	38722 Washer 5/16 200 Pieces	38723 Washer 3/8 100 Pieces	38724 Washer 7/16 100 Pieces	38725 Washer 1/2 50 Pieces	38726 Washer 9/16 25 Pieces	38727 Washer 5/8 25 Pieces	38728 Washer 3/4 25 Pieces
37851 High Hex 1/4 100 Pieces	37852 High Hex 5/16 100 Pieces	37853 High Hex 3/8 100 Pieces	37854 High Hex 7/16 50 Pieces	37855 High Hex 1/2 50 Pieces	37856 High Hex 9/16 25 Pieces	37857 High Hex 5/8 25 Pieces	37858 High Hex 3/4 25 Pieces

40 Bin

40000 1/4 x 1/2 20 Pieces	40027 5/16 x 3/4 20 Pieces	40054 3/8 x 1 20 Pieces	40077 7/16 x 3/4 10 Pieces	40104 1/2 x 1 10 Pieces	40129 9/16 x 1 10 Pieces	40147 5/8 x 1 1/2 10 Pieces	40172 3/4 x 2 10 Pieces
40002 1/4 x 3/4 20 Pieces	40029 5/16 x 1 20 Pieces	40055 3/8 x 1 1/4 20 Pieces	40079 7/16 x 1 10 Pieces	40106 1/2 x 1 1/2 10 Pieces	40131 9/16 x 1 1/2 10 Pieces	40149 5/8 x 2 5 Pieces	40174 3/4 x 2 1/2 10 Pieces
40004 1/4 x 1 20 Pieces	40030 5/16 x 1 1/4 20 Pieces	40056 3/8 x 1 1/2 20 Pieces	40081 7/16 x 1 1/2 10 Pieces	40108 1/2 x 2 10 Pieces	40133 9/16 x 2 10 Pieces	40151 5/8 x 2 1/2 5 Pieces	40176 3/4 x 3 5 Pieces
40005 1/4 x 1 1/4 20 Pieces	40031 5/16 x 1 1/2 20 Pieces	40058 3/8 x 2 20 Pieces	40083 7/16 x 2 10 Pieces	40110 1/2 x 2 1/2 10 Pieces	40135 9/16 x 2 1/2 5 Pieces	40153 5/8 x 3 5 Pieces	40178 3/4 x 3 1/2 5 Pieces
40006 1/4 x 1 1/2 20 Pieces	40033 5/16 x 2 20 Pieces	40060 3/8 x 2 1/2 20 Pieces	40085 7/16 x 2 1/2 10 Pieces	40112 1/2 x 3 10 Pieces	40137 9/16 x 3 5 Pieces	40155 5/8 x 3 1/2 5 Pieces	40180 3/4 x 4 5 Pieces
40008 1/4 x 2 20 Pieces	40035 5/16 x 2 1/2 20 Pieces	40062 3/8 x 3 20 Pieces	40087 7/16 x 3 10 Pieces	40116 1/2 x 4 10 Pieces	40139 9/16 x 3 1/2 5 Pieces	40157 5/8 x 4 5 Pieces	40181 3/4 x 4 1/2 5 Pieces
40010 1/4 x 2 1/2 20 Pieces	40037 5/16 x 3 20 Pieces	40066 3/8 x 4 20 Pieces	40089 7/16 x 3 1/2 10 Pieces	40117 1/2 x 4 1/2 10 Pieces	40140 9/16 x 4 5 Pieces	40158 5/8 x 4 1/2 5 Pieces	40182 3/4 x 5 5 Pieces
40012 1/4 x 3 20 Pieces	40040 5/16 x 4 20 Pieces	40067 3/8 x 4 1/2 20 Pieces	40091 7/16 x 4 10 Pieces	40118 1/2 x 5 10 Pieces	40142 9/16 x 5 5 Pieces	40159 5/8 x 5 5 Pieces	40183 3/4 x 5 1/2 5 Pieces
40014 1/4 x 4 20 Pieces	40042 5/16 x 5 20 Pieces	40068 3/8 x 5 20 Pieces	40093 7/16 x 5 10 Pieces	40120 1/2 x 6 10 Pieces	40144 9/16 x 6 5 Pieces	40161 5/8 x 6 5 Pieces	40184 3/4 x 6 5 Pieces

LABEL ONLY

72 Bin

CD-535 - Custom w/ Prevailing Torque Nuts
GRADE 8 SAE 1/4 to 3/4

Label Sets:

- LB-906
- LB-907
- LB-918
- LB-904
- LB-909
- LB-913

CD-357
Torque Nuts*



CD-801
High Hex Nuts

40621 Nut 1/4 100 Pieces	40622 Nut 5/16 100 Pieces	40623 Nut 3/8 100 Pieces	40624 Nut 7/16 50 Pieces	40625 Nut 1/2 50 Pieces	40626 Nut 9/16 25 Pieces	40627 Nut 5/8 25 Pieces	40628 Nut 3/4 25 Pieces
40751 L. Washer 1/4 100 Pieces	40752 L. Washer 5/16 100 Pieces	40753 L. Washer 3/8 100 Pieces	40754 L. Washer 7/16 100 Pieces	40755 L. Washer 1/2 50 Pieces	40756 L. Washer 9/16 50 Pieces	40757 L. Washer 5/8 25 Pieces	40758 L. Washer 3/4 25 Pieces
37795 Lock Nuts 1/4 100 Pieces	37796 Lock Nuts 5/16 100 Pieces	37797 Lock Nuts 3/8 100 Pieces	37798 Lock Nuts 7/16 100 Pieces	37799 Lock Nuts 1/2 50 Pieces	37800 Lock Nuts 9/16 50 Pieces	37801 Lock Nuts 5/8 25 Pieces	37802 Lock Nuts 3/4 25 Pieces
38701 Washer 1/4 200 Pieces	38702 Washer 5/16 200 Pieces	38703 Washer 3/8 100 Pieces	38704 Washer 7/16 100 Pieces	38705 Washer 1/2 50 Pieces	38706 Washer 9/16 25 Pieces	38707 Washer 5/8 25 Pieces	38708 Washer 3/4 25 Pieces
37871 High Hex 1/4 100 Pieces	37872 High Hex 5/16 100 Pieces	37873 High Hex 3/8 100 Pieces	37874 High Hex 7/16 50 Pieces	37875 High Hex 1/2 50 Pieces	37876 High Hex 9/16 25 Pieces	37877 High Hex 5/8 25 Pieces	37878 High Hex 3/4 25 Pieces

40 Bin

40300 1/4 x 1/2 20 Pieces	40327 5/16 x 3/4 20 Pieces	40354 3/8 x 1 20 Pieces	40377 7/16 x 3/4 10 Pieces	40404 1/2 x 1 10 Pieces	40429 9/16 x 1 10 Pieces	40447 5/8 x 1 1/2 10 Pieces	40472 3/4 x 2 10 Pieces
40302 1/4 x 3/4 20 Pieces	40329 5/16 x 1 20 Pieces	40355 3/8 x 1 1/4 20 Pieces	40379 7/16 x 1 10 Pieces	40406 1/2 x 1 1/2 10 Pieces	40431 9/16 x 1 1/2 10 Pieces	40449 5/8 x 2 5 Pieces	40474 3/4 x 2 1/2 10 Pieces
40304 1/4 x 1 20 Pieces	40330 5/16 x 1 1/4 20 Pieces	40356 3/8 x 1 1/2 20 Pieces	40381 7/16 x 1 1/2 10 Pieces	40408 1/2 x 2 10 Pieces	40433 9/16 x 2 10 Pieces	40451 5/8 x 2 1/2 5 Pieces	40476 3/4 x 3 5 Pieces
40305 1/4 x 1 1/4 20 Pieces	40331 5/16 x 1 1/2 20 Pieces	40358 3/8 x 2 20 Pieces	40383 7/16 x 2 10 Pieces	40410 1/2 x 2 1/2 10 Pieces	40435 9/16 x 2 1/2 5 Pieces	40453 5/8 x 3 5 Pieces	40478 3/4 x 3 1/2 5 Pieces
40306 1/4 x 1 1/2 20 Pieces	40333 5/16 x 2 20 Pieces	40360 3/8 x 2 1/2 20 Pieces	40385 7/16 x 2 1/2 10 Pieces	40412 1/2 x 3 10 Pieces	40437 9/16 x 3 5 Pieces	40455 5/8 x 3 1/2 5 Pieces	40480 3/4 x 4 5 Pieces
40308 1/4 x 2 20 Pieces	40335 5/16 x 2 1/2 20 Pieces	40362 3/8 x 3 20 Pieces	40387 7/16 x 3 10 Pieces	40416 1/2 x 4 10 Pieces	40439 9/16 x 3 1/2 5 Pieces	40457 5/8 x 4 5 Pieces	40481 3/4 x 4 1/2 5 Pieces
40310 1/4 x 2 1/2 20 Pieces	40337 5/16 x 3 20 Pieces	40366 3/8 x 4 20 Pieces	40389 7/16 x 3 1/2 10 Pieces	40417 1/2 x 4 1/2 10 Pieces	40440 9/16 x 4 5 Pieces	40458 5/8 x 4 1/2 5 Pieces	40482 3/4 x 5 5 Pieces
40312 1/4 x 3 20 Pieces	40340 5/16 x 4 20 Pieces	40367 3/8 x 4 1/2 20 Pieces	40391 7/16 x 4 10 Pieces	40418 1/2 x 5 10 Pieces	40442 9/16 x 5 5 Pieces	40459 5/8 x 5 5 Pieces	40483 3/4 x 5 1/2 5 Pieces
40314 1/4 x 4 20 Pieces	40342 5/16 x 5 20 Pieces	40368 3/8 x 5 20 Pieces	40393 7/16 x 5 10 Pieces	40420 1/2 x 6 10 Pieces	40444 9/16 x 6 5 Pieces	40461 5/8 x 6 5 Pieces	40484 3/4 x 6 5 Pieces

LABEL ONLY

72 Bin

CD-534 - Custom w/ Nylocks
GRADE 8 USS 1/4 to 3/4

Label Sets:

LB-905
LB-907
LB-915
LB-903
LB-908
LB-912

CD-355
Nylocks



CD-800
High Hex Nuts

40 Bin

40601 Nut 1/4 100 Pieces	40602 Nut 5/16 100 Pieces	40603 Nut 3/8 100 Pieces	40604 Nut 7/16 50 Pieces	40605 Nut 1/2 50 Pieces	40606 Nut 9/16 25 Pieces	40607 Nut 5/8 25 Pieces	40608 Nut 3/4 25 Pieces
40751 L. Washer 1/4 100 Pieces	40752 L. Washer 5/16 100 Pieces	40753 L. Washer 3/8 100 Pieces	40754 L. Washer 7/16 100 Pieces	40755 L. Washer 1/2 50 Pieces	40756 L. Washer 9/16 50 Pieces	40757 L. Washer 5/8 25 Pieces	40758 L. Washer 3/4 25 Pieces
71801 Nylocks 1/4 100 Pieces	71802 Nylocks 5/16 100 Pieces	71803 Nylocks 3/8 100 Pieces	71804 Nylocks 7/16 100 Pieces	71805 Nylocks 1/2 50 Pieces	71806 Nylocks 9/16 50 Pieces	71807 Nylocks 5/8 25 Pieces	71808 Nylocks 3/4 25 Pieces
38721 Washer 1/4 200 Pieces	38722 Washer 5/16 200 Pieces	38723 Washer 3/8 100 Pieces	38724 Washer 7/16 100 Pieces	38725 Washer 1/2 50 Pieces	38726 Washer 9/16 25 Pieces	38727 Washer 5/8 25 Pieces	38728 Washer 3/4 25 Pieces
37851 High Hex 1/4 100 Pieces	37852 High Hex 5/16 100 Pieces	37853 High Hex 3/8 100 Pieces	37854 High Hex 7/16 50 Pieces	37855 High Hex 1/2 50 Pieces	37856 High Hex 9/16 25 Pieces	37857 High Hex 5/8 25 Pieces	37858 High Hex 3/4 25 Pieces

LABEL ONLY

40000 1/4 x 1/2 20 Pieces	40027 5/16 x 3/4 20 Pieces	40054 3/8 x 1 20 Pieces	40077 7/16 x 3/4 10 Pieces	40104 1/2 x 1 10 Pieces	40129 9/16 x 1 10 Pieces	40147 5/8 x 1 1/2 10 Pieces	40172 3/4 x 2 10 Pieces
40002 1/4 x 3/4 20 Pieces	40029 5/16 x 1 20 Pieces	40055 3/8 x 1 1/4 20 Pieces	40079 7/16 x 1 10 Pieces	40106 1/2 x 1 1/2 10 Pieces	40131 9/16 x 1 1/2 10 Pieces	40149 5/8 x 2 5 Pieces	40174 3/4 x 2 1/2 10 Pieces
40004 1/4 x 1 20 Pieces	40030 5/16 x 1 1/4 20 Pieces	40056 3/8 x 1 1/2 20 Pieces	40081 7/16 x 1 1/2 10 Pieces	40108 1/2 x 2 10 Pieces	40133 9/16 x 2 10 Pieces	40151 5/8 x 2 1/2 5 Pieces	40176 3/4 x 3 5 Pieces
40005 1/4 x 1 1/4 20 Pieces	40031 5/16 x 1 1/2 20 Pieces	40058 3/8 x 2 20 Pieces	40083 7/16 x 2 10 Pieces	40110 1/2 x 2 1/2 10 Pieces	40135 9/16 x 2 1/2 5 Pieces	40153 5/8 x 3 5 Pieces	40178 3/4 x 3 1/2 5 Pieces
40006 1/4 x 1 1/2 20 Pieces	40033 5/16 x 2 20 Pieces	40060 3/8 x 2 1/2 20 Pieces	40085 7/16 x 2 1/2 10 Pieces	40112 1/2 x 3 10 Pieces	40137 9/16 x 3 5 Pieces	40155 5/8 x 3 1/2 5 Pieces	40180 3/4 x 4 5 Pieces
40008 1/4 x 2 20 Pieces	40035 5/16 x 2 1/2 20 Pieces	40062 3/8 x 3 20 Pieces	40087 7/16 x 3 10 Pieces	40116 1/2 x 4 10 Pieces	40139 9/16 x 3 1/2 5 Pieces	40157 5/8 x 4 5 Pieces	40181 3/4 x 4 1/2 5 Pieces
40010 1/4 x 2 1/2 20 Pieces	40037 5/16 x 3 20 Pieces	40066 3/8 x 4 20 Pieces	40089 7/16 x 3 1/2 10 Pieces	40117 1/2 x 4 1/2 10 Pieces	40140 9/16 x 4 5 Pieces	40158 5/8 x 4 1/2 5 Pieces	40182 3/4 x 5 5 Pieces
40012 1/4 x 3 20 Pieces	40040 5/16 x 4 20 Pieces	40067 3/8 x 4 1/2 20 Pieces	40091 7/16 x 4 10 Pieces	40118 1/2 x 5 10 Pieces	40142 9/16 x 5 5 Pieces	40159 5/8 x 5 5 Pieces	40183 3/4 x 5 1/2 5 Pieces
40014 1/4 x 4 20 Pieces	40042 5/16 x 5 20 Pieces	40068 3/8 x 5 20 Pieces	40093 7/16 x 5 10 Pieces	40120 1/2 x 6 10 Pieces	40144 9/16 x 6 5 Pieces	40161 5/8 x 6 5 Pieces	40184 3/4 x 6 5 Pieces

72 Bin

CD-535 - Custom w/ Nylocks
GRADE 8 SAE 1/4 to 3/4

Label Sets:

LB-906
LB-907
LB-916
LB-904
LB-909
LB-913

CD-356
Nylocks



CD-801
High Hex Nuts

40621 Nut 1/4 100 Pieces	40622 Nut 5/16 100 Pieces	40623 Nut 3/8 100 Pieces	40624 Nut 7/16 50 Pieces	40625 Nut 1/2 50 Pieces	40626 Nut 9/16 25 Pieces	40627 Nut 5/8 25 Pieces	40628 Nut 3/4 25 Pieces
40751 L. Washer 1/4 100 Pieces	40752 L. Washer 5/16 100 Pieces	40753 L. Washer 3/8 100 Pieces	40754 L. Washer 7/16 100 Pieces	40755 L. Washer 1/2 50 Pieces	40756 L. Washer 9/16 50 Pieces	40757 L. Washer 5/8 25 Pieces	40758 L. Washer 3/4 25 Pieces
71821 Nylocks 1/4 100 Pieces	71822 Nylocks 5/16 100 Pieces	71823 Nylocks 3/8 100 Pieces	71824 Nylocks 7/16 100 Pieces	71825 Nylocks 1/2 50 Pieces	71826 Nylocks 9/16 50 Pieces	71827 Nylocks 5/8 25 Pieces	71828 Nylocks 3/4 25 Pieces
38701 Washer 1/4 200 Pieces	38702 Washer 5/16 200 Pieces	38703 Washer 3/8 100 Pieces	38704 Washer 7/16 100 Pieces	38705 Washer 1/2 50 Pieces	38706 Washer 9/16 25 Pieces	38707 Washer 5/8 25 Pieces	38708 Washer 3/4 25 Pieces
37871 High Hex 1/4 100 Pieces	37872 High Hex 5/16 100 Pieces	37873 High Hex 3/8 100 Pieces	37874 High Hex 7/16 50 Pieces	37875 High Hex 1/2 50 Pieces	37876 High Hex 9/16 25 Pieces	37877 High Hex 5/8 25 Pieces	37878 High Hex 3/4 25 Pieces

40 Bin

40300 1/4 x 1/2 20 Pieces	40327 5/16 x 3/4 20 Pieces	40354 3/8 x 1 20 Pieces	40377 7/16 x 3/4 10 Pieces	40404 1/2 x 1 10 Pieces	40429 9/16 x 1 10 Pieces	40447 5/8 x 1 1/2 10 Pieces	40472 3/4 x 2 10 Pieces
40302 1/4 x 3/4 20 Pieces	40329 5/16 x 1 20 Pieces	40355 3/8 x 1 1/4 20 Pieces	40379 7/16 x 1 10 Pieces	40406 1/2 x 1 1/2 10 Pieces	40431 9/16 x 1 1/2 10 Pieces	40449 5/8 x 2 5 Pieces	40474 3/4 x 2 1/2 10 Pieces
40304 1/4 x 1 20 Pieces	40330 5/16 x 1 1/4 20 Pieces	40356 3/8 x 1 1/2 20 Pieces	40381 7/16 x 1 1/2 10 Pieces	40408 1/2 x 2 10 Pieces	40433 9/16 x 2 10 Pieces	40451 5/8 x 2 1/2 5 Pieces	40476 3/4 x 3 5 Pieces
40305 1/4 x 1 1/4 20 Pieces	40331 5/16 x 1 1/2 20 Pieces	40358 3/8 x 2 20 Pieces	40383 7/16 x 2 10 Pieces	40410 1/2 x 2 1/2 10 Pieces	40435 9/16 x 2 1/2 5 Pieces	40453 5/8 x 3 5 Pieces	40478 3/4 x 3 1/2 5 Pieces
40306 1/4 x 1 1/2 20 Pieces	40333 5/16 x 2 20 Pieces	40360 3/8 x 2 1/2 20 Pieces	40385 7/16 x 2 1/2 10 Pieces	40412 1/2 x 3 10 Pieces	40437 9/16 x 3 5 Pieces	40455 5/8 x 3 1/2 5 Pieces	40480 3/4 x 4 5 Pieces
40308 1/4 x 2 20 Pieces	40335 5/16 x 2 1/2 20 Pieces	40362 3/8 x 3 20 Pieces	40387 7/16 x 3 10 Pieces	40416 1/2 x 4 10 Pieces	40439 9/16 x 3 1/2 5 Pieces	40457 5/8 x 4 5 Pieces	40481 3/4 x 4 1/2 5 Pieces
40310 1/4 x 2 1/2 20 Pieces	40337 5/16 x 3 20 Pieces	40366 3/8 x 4 20 Pieces	40389 7/16 x 3 1/2 10 Pieces	40417 1/2 x 4 1/2 10 Pieces	40440 9/16 x 4 5 Pieces	40458 5/8 x 4 1/2 5 Pieces	40482 3/4 x 5 5 Pieces
40312 1/4 x 3 20 Pieces	40340 5/16 x 4 20 Pieces	40367 3/8 x 4 1/2 20 Pieces	40391 7/16 x 4 10 Pieces	40418 1/2 x 5 10 Pieces	40442 9/16 x 5 5 Pieces	40459 5/8 x 5 5 Pieces	40483 3/4 x 5 1/2 5 Pieces
40314 1/4 x 4 20 Pieces	40342 5/16 x 5 20 Pieces	40368 3/8 x 5 20 Pieces	40393 7/16 x 5 10 Pieces	40420 1/2 x 6 10 Pieces	40444 9/16 x 6 5 Pieces	40461 5/8 x 6 5 Pieces	40484 3/4 x 6 5 Pieces

LABEL ONLY

72 Bin

Hellerman Tyton
Custom
***Modified 99923 (20 bin)**

75330 20pcs.	75331 50pcs.	75332 20pcs.	75333 20pcs.
75334 20pcs.	75335 20pcs.	75336 20pcs.	75337 20pcs.
75338 20pcs.	75339 50pcs.	75340 50pcs.	
75341 50pcs.		75342 20pcs.	
75343 50pcs.	75345 20pcs.	75346 20pcs.	



Hydraulic Assortment - E Series

Custom - 1 Full bag of each item

Label Sets: LB-952 Coll E Series Print ranges 98035 thru 98055 for collets

98040	98041	98042	98043	98044	98045	98046	
98035	98038	98052	98053	98055			
78001	78013	78020	78035	78100	78150	78200	78250
78002	78014	78021	78036	78101	78151	78201	78251
78003		78022	78037	78102	78152	78202	78252

40 Bin

78004		78023	78038	78103	78153	78203	78253
78005		78024	78039	78104	78154	78204	78254
78006		78025	78040		78155		78255
78007		78026	78041		78156		78256
78008		78027	78042		78157		78257
78009		78028	78043		78158		78258
78010		78029					78259
78011		78030					
78012		78031					

72 Bin



Black Pipe Assortment Custom - 2pc. each

Label Sets Required:

LB-967 Black Pipe Assortment

70010	70021	70036	70725	70770	70901	70932	
70011	70022	70037	70726	70771	70902	70933	
70012	70023	70038	70728	70772	70903	70934	
70013	70024	70039	70729	70780	70904	70952	
70014	70025	70040	70750	70781	70911	70953	
70126	70700	70041	70751	70782	70912	70954	
70127	70701	70042	70752	70783	70913	70955	
70128	70702	70043	70753	70810	70914		
70129	70703	70180	70786	70811	70915		

72 Bin